



RIO range

Installation, operating, and instruction manual

Please leave this manual with the end user

Class I - 230V - 50 Hz

Register your warranty
online at www.myson.co.uk

comfort delivered by



MYSON

1

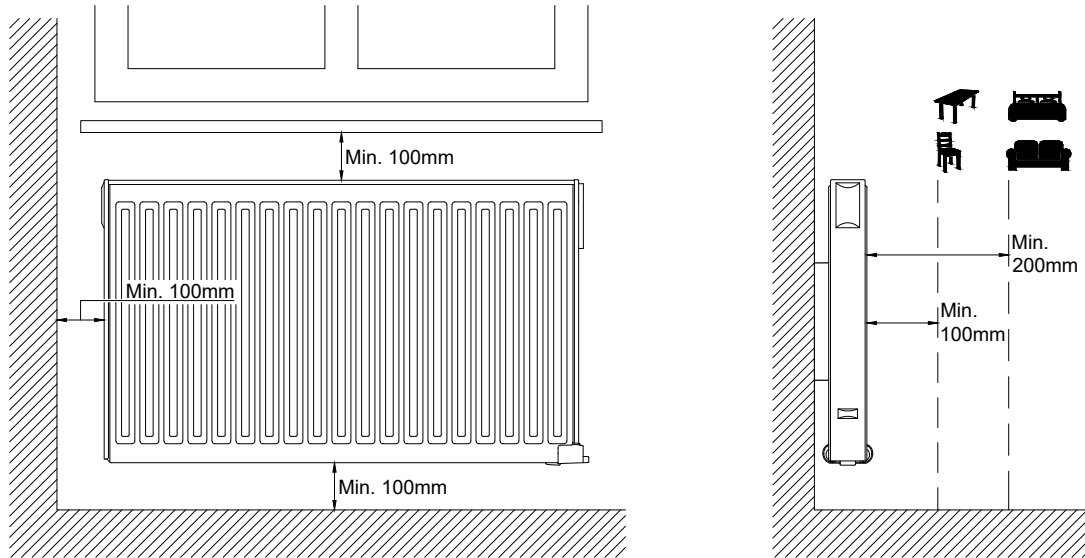

2

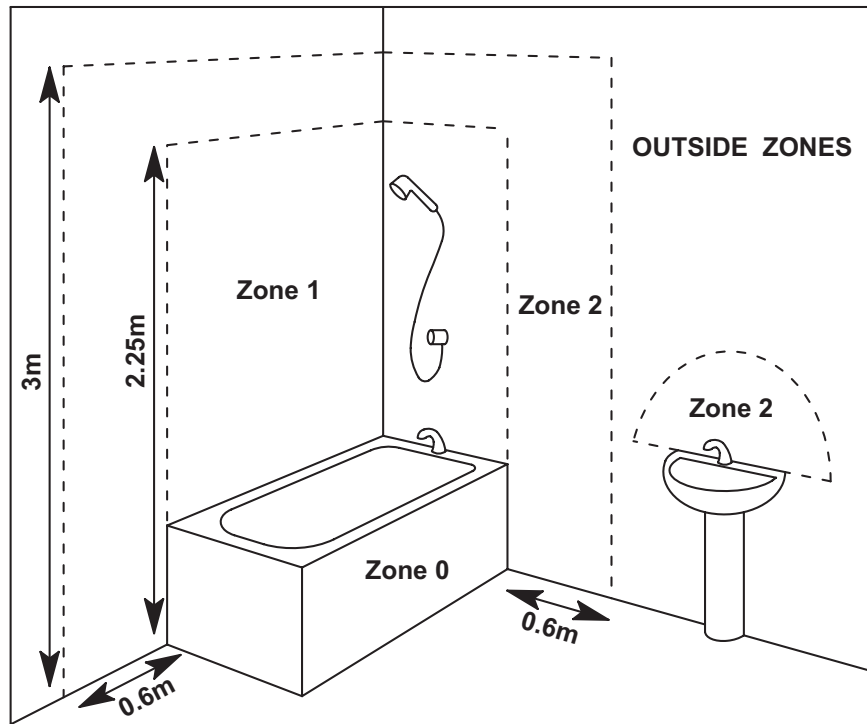

3A

Safety Clip-on Brackets

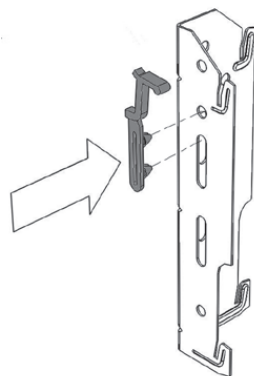

Step 1

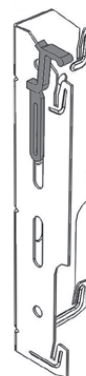

Step 2

3B

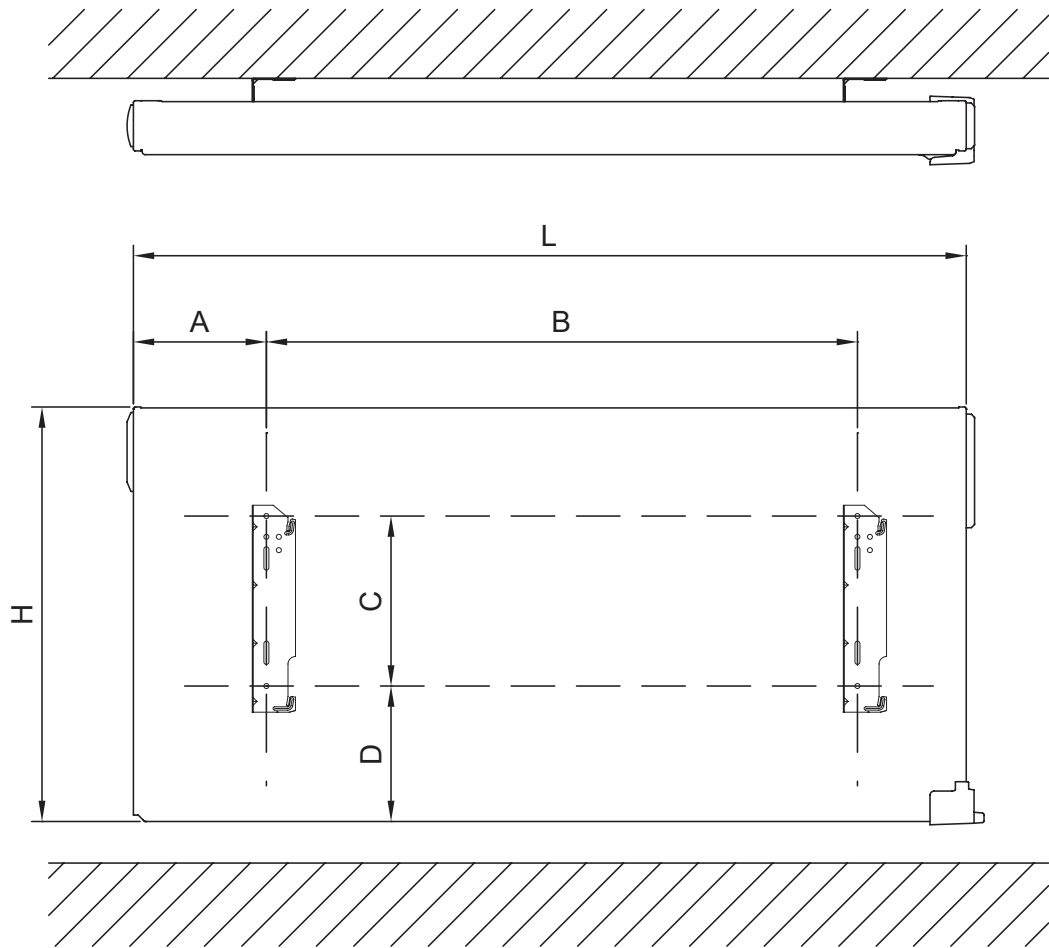

Height (mm)	300	500
C	135	205
D	90	163

Length (mm)	400	500	650	800	950	1000	1250	1300	1600	2000
A	160	160	160	160	160	160	160	160	160	160
B	101	203	355	508	660	711	965	1016	1320	1727

3C

Cable Hook Assembly

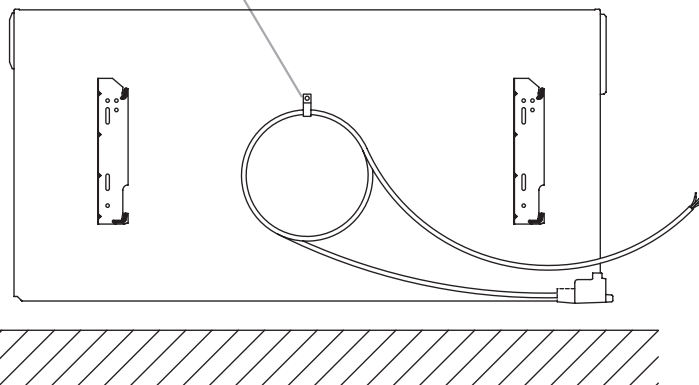
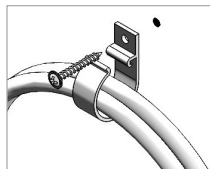

4A Stand alone operation

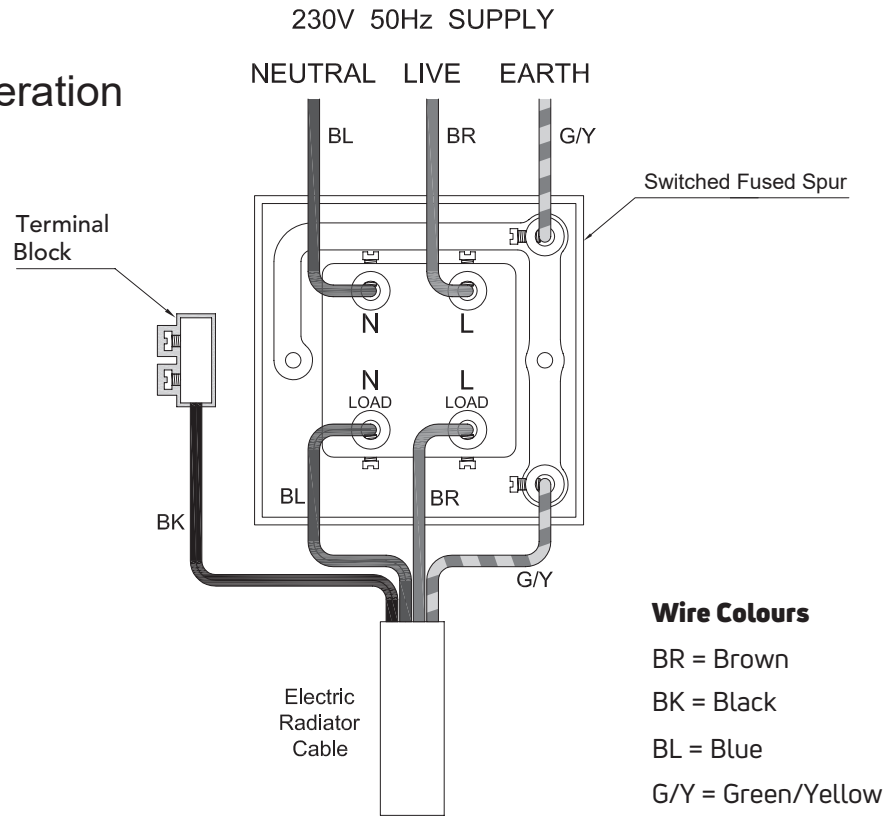

4B Connected to a Touch 4 programmer

PILOT WIRE FROM PROGRAMMER
(switched live)

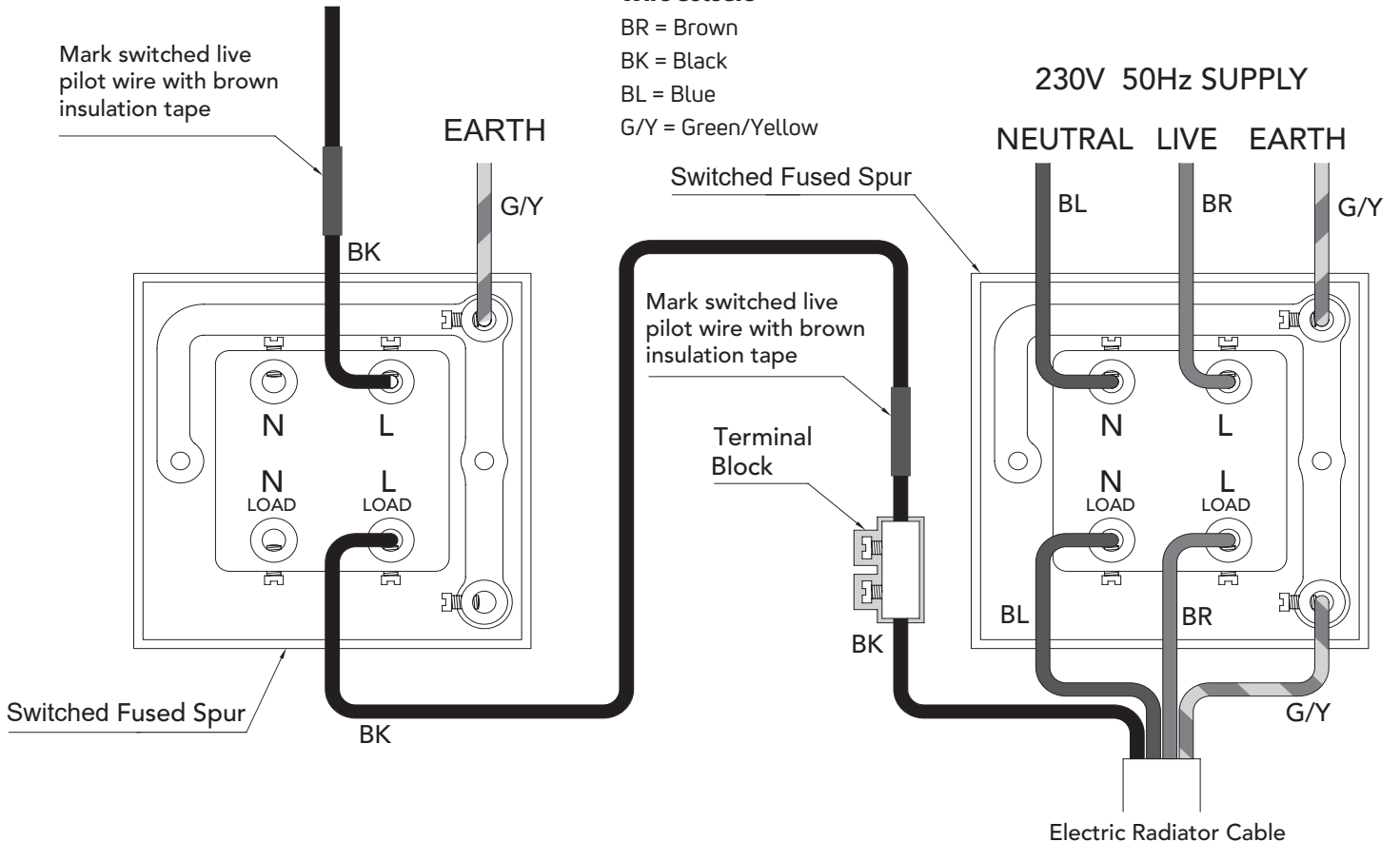

4C

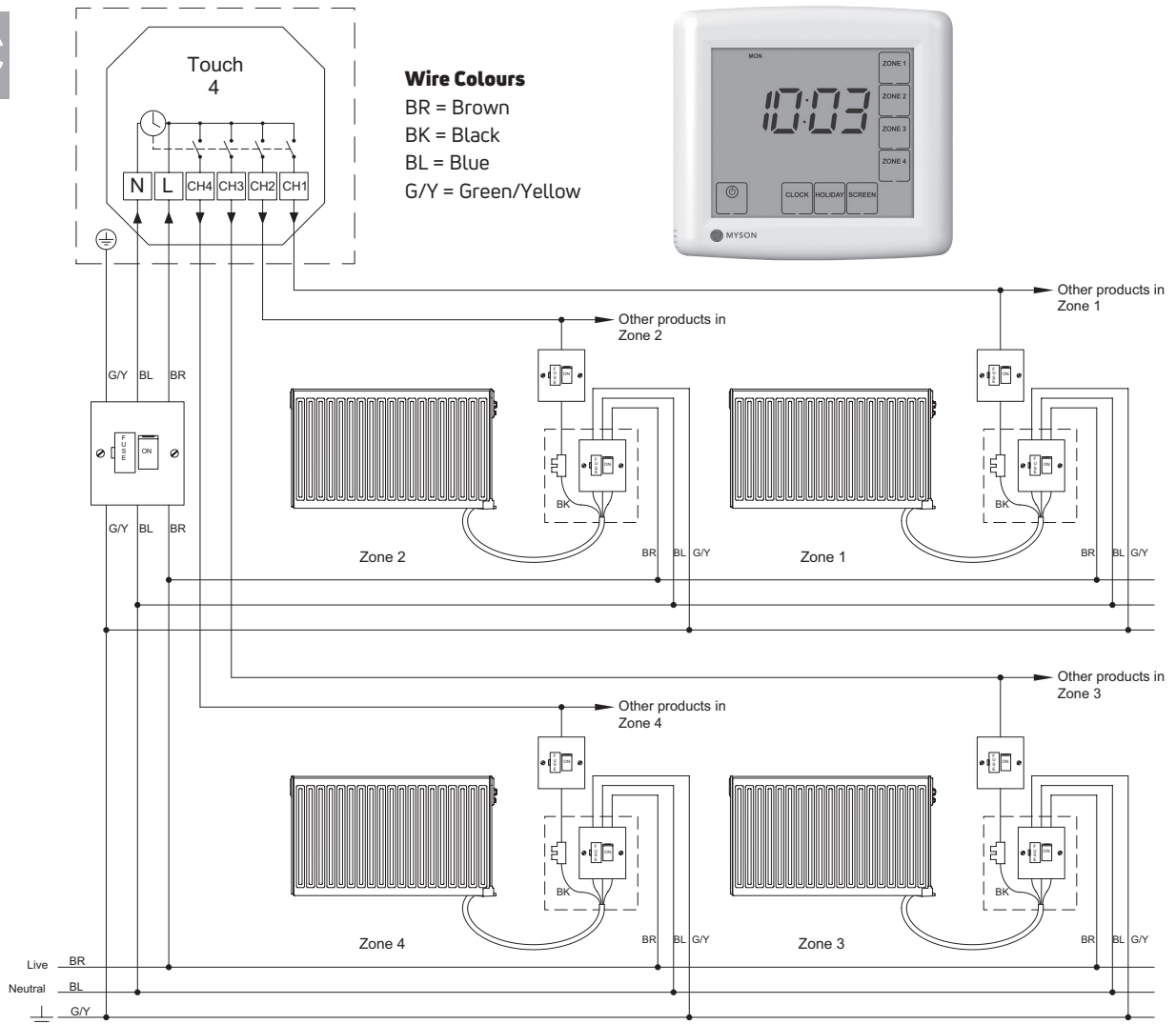

A suitable means of local isolation of the radiator from both the electrical supply and the pilot wire signal must be provided. The fused spurs must be clearly marked to indicate that two sources of electrical supply may be present. The outputs from the programmer are switched Live.

4D

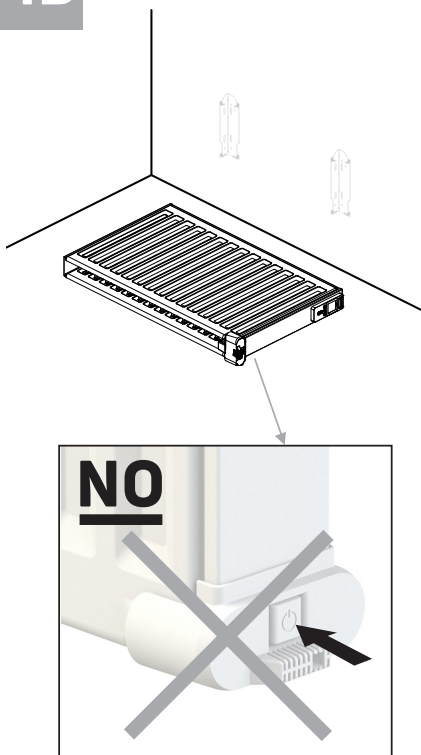

5

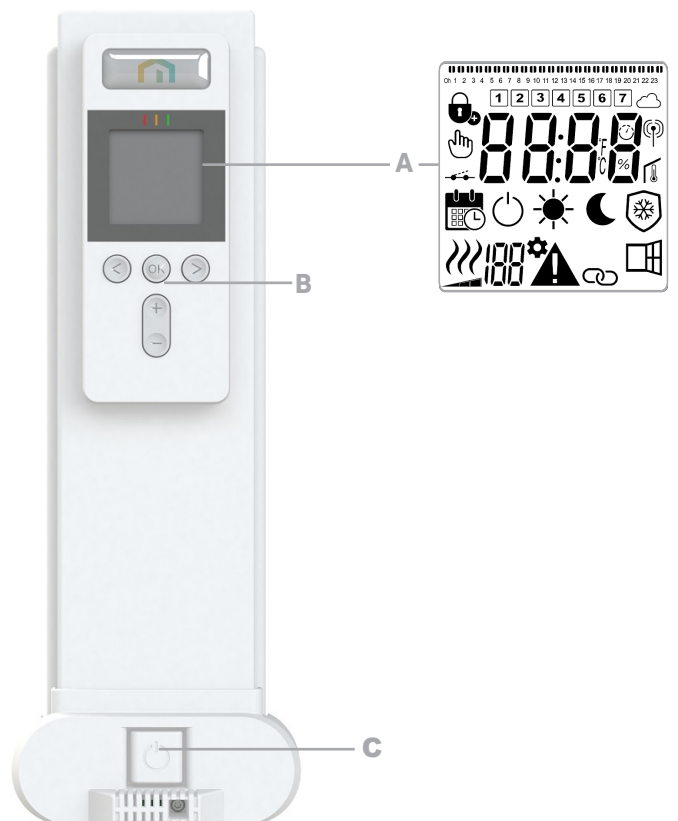

7

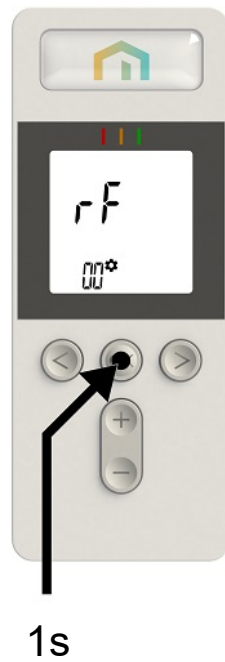
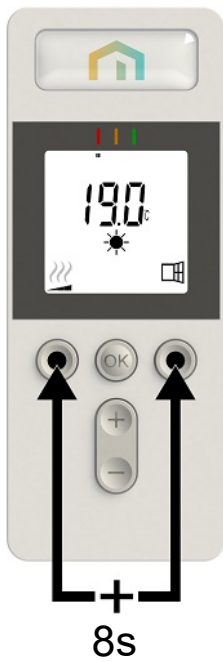
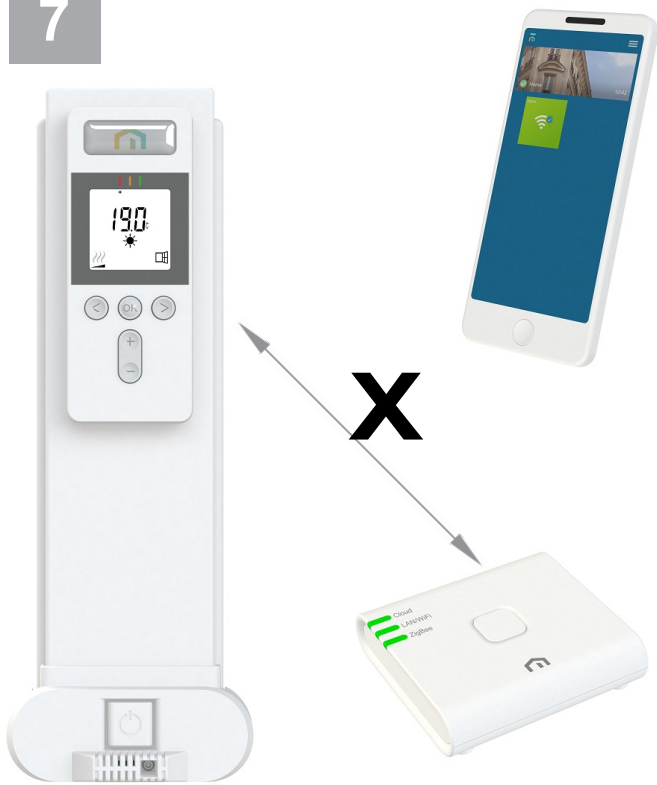

SAFETY INFORMATION

Due to the safety standard EN 60335, the text below is obligatory for all electric products, not only radiators.

This appliance can be used by children aged from 8 years and above and persons with reduced physical, sensory or mental capabilities or lack of experience and knowledge if they have been given supervision or instruction concerning use of the appliance in a safe way and understand the hazards involved. Children shall not play with the appliance. Cleaning and user maintenance shall not be made by children unless they are older than 8 and supervised. Keep the appliance and its cord

out of reach of children aged less than 8 years. Children of less than 3 years should be kept away from the unit unless continuously supervised. Children aged from 3 years and less than 8 years shall only switch on/off the appliance provided that it has been placed or installed in its normal operating position and they have been given supervision or instruction concerning use of the appliance in a safe way and understand the hazards involved. Children aged from 3 years and less than 8 years shall not plug in, regulate and clean the appliance or perform user maintenance.



CAUTION

SOME PARTS OF THIS PRODUCT CAN BECOME VERY HOT AND CAUSE BURNS. PARTICULAR ATTENTION HAS TO BE GIVEN WHERE CHILDREN AND VULNERABLE PEOPLE ARE PRESENT. IN ORDER TO AVOID OVERHEATING, DO NOT COVER THE RADIATOR. "DO NOT COVER" MEANS THAT THE RADIATOR MUST NOT BE USED FOR DRYING CLOTHES, FOR EXAMPLE, BY PLACING THEM DIRECTLY ON THE RADIATOR.



WASTE DISPOSAL ACCORDING TO WEEE DIRECTIVE (2012/19/EU)

WASTE DISPOSAL ACCORDING TO THE WEEE DIRECTIVE (2012/19/EU). THE SYMBOL ON THE PRODUCT LABEL INDICATES THAT THE PRODUCT MAY NOT BE HANDLED AS DOMESTIC WASTE, BUT MUST BE SORTED SEPARATELY. WHEN IT REACHES THE END OF ITS USEFUL LIFE, IT SHALL BE RETURNED TO A COLLECTION FACILITY FOR ELECTRICAL AND ELECTRONIC PRODUCTS. BY RETURNING THE PRODUCT, YOU WILL HELP TO PREVENT POSSIBLE NEGATIVE EFFECTS ON THE ENVIRONMENT AND HEALTH TO WHICH THE PRODUCT CAN CONTRIBUTE IF IT IS DISPOSED OF AS ORDINARY DOMESTIC WASTE. FOR INFORMATION ABOUT RECYCLING AND COLLECTION FACILITIES, YOU SHOULD CONTACT YOUR LOCAL AUTHORITY/MUNICIPALITY OR REFUSE COLLECTION SERVICE OR THE BUSINESS FROM WHICH YOU PURCHASED THE PRODUCT. APPLICABLE TO COUNTRIES WHERE THIS DIRECTIVE HAS BEEN ADOPTED.

WEEE NO: WEE/HD0506VZ

1. GENERAL INFO

- This appliance is a sealed electric radiator designed for fixed wall-mounted installation.
- This appliance conforms to the standards EN 60335-1 and EN 60335-2-30.
- The appliance is insulation class I and has electrical protection level IP44.
- This appliance complies with European Directive 2014/30/EU (CE Marking on all appliances).
- The product is supplied complete with a connection cable and wall brackets.

2. INSTALLATION

POSITIONING

- The radiator must be positioned horizontally in order for it to function correctly.
- The radiator must be positioned according to the applicable standards. The minimum distances as specified in picture 1 should be carefully observed.
- The radiator may be positioned inside zone 2 (picture 2), insofar as no operating controls (button, switches, etc ...) are in reach of persons in the bath or under the shower.
- The radiator must be fixed to the wall using the wall brackets supplied.
- The radiator must not be located underneath an electrical socket.

FIXING

- Mark out the distance between the brackets and the positions of the screw holes as shown in the table in picture 3B.
- Ensure that the safety clips are used, as shown in picture 3A.

NOTE: 2000 mm long products are supplied with extra brackets as a 3rd bracket must be fitted in the middle of the product.

- For the correct installation of radiators it is essential that the fixing of the radiator is carried out in such a way that it is suitable for intended use AND predictable misuse. A number of elements need to be taken into consideration including the fixing method used to secure the radiator to the wall, the type and condition of the wall itself, and any additional potential forces or weights, prior to finalising installation.
- The fixing materials provided are only intended for installation on walls made of solid wood, bricks, concrete or on timber-frame stud walls where the fixing is directly into the timber. All walls being considered should have no more than a maximum of 3 mm wall finishing. For walls made of other materials, for example hollow bricks; please consult your installer and/or specialist supplier.

In all cases it is strongly recommended that a suitably qualified professional installer or similar tradesperson carries out the installation.

CONNECTION

- The electrical installation must comply with local or national regulations.
- The radiator should be connected by a suitable and qualified electrician. Please refer to the wiring diagrams in pictures 4A, or 4B and 4C for the connection of the radiator.
- The radiator must be connected to the electrical supply, using a switched fused spur with 3mm separation on all poles.
- The radiator must be connected to the electrical supply using the supply cable fitted to the unit.
- If the radiator is installed in a bathroom or shower room, it must be protected with a residual current device (RCD) with a rated residual current not exceeding 30 mA.
- The radiator is equipped with a non-resettable overheat protection that trips off if the radiator overheats. If the radiator is removed from the wall brackets, even for a short time, it must without exception be switched off, see picture 4D. This may even trip the non-resettable overheat protection. If the overheat protection trips, its thermal fuse must be replaced; contact your supplier.

3. OPERATION

• The On/Off button is located at the bottom of the control side of the radiator (C, picture 5). The radiator should only be switched “on” when it is correctly installed and secured to the wall brackets (picture 3C). When the radiator is switched “on”, the LCD screen will illuminate and all segments will be displayed for a few seconds, then disappear, before displaying the software version. The “Comfort” or previously selected operating mode screen will appear. The backlight will switch off after a further 5 seconds.

• Display (A, picture 5)

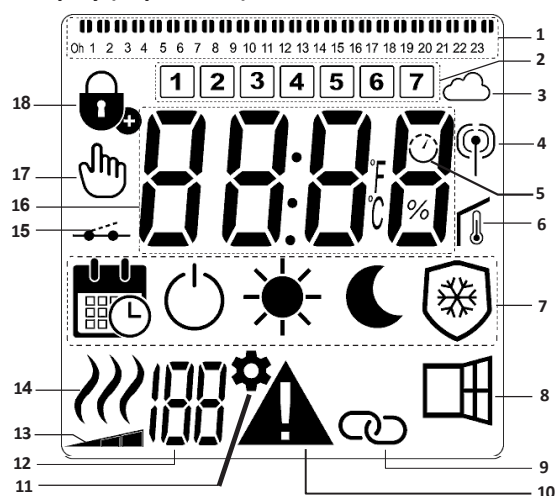

1. Program information bar or “behaviour” indicator.
2. Day of week indicator.
3. Cloud icon (with Unisenza PLUS Gateway).
4. “RF connection” indicator (with Unisenza PLUS Gateway).
5. Adaptive Start indicator.
6. “Room temperature” indicator.
7. Operating mode menu.
8. "Open Window" function indicator.
9. Master/Follower indicator (with Unisenza PLUS Gateway).
10. Warning indicator.
11. Installation parameter indicator.
12. Parameters number when icon “11” is displayed.
13. Front panel temperature limit indicator.
14. Heating demand indicator.
15. Pilot wire indicator.
16. Display zone for temperatures or time.
17. Hand icon.
18. “Key lock” function indicator.

• Keypad (B, Picture 5)

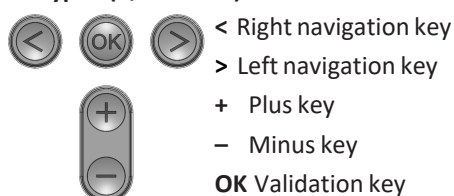

GENERAL

HOW TO CHANGE BETWEEN THE OPERATING MODES

In basic mode, only Comfort and Program mode are available.

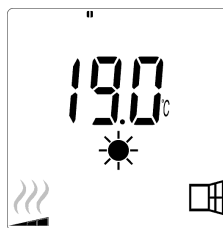

- Press any button to turn on the backlight.
- Press the "<" or ">" buttons to enable scrolling between modes.

- Use the left "<" or right ">" buttons to move to the desired operating mode and press “OK” to confirm your choice.

HOW TO CHANGE COMFORT AND PROGRAM MODE TEMPERATURES

- Press any button to turn on the backlight.
- By pressing the “+” or “-” buttons, the set temperature will start to blink and can be adjusted to the desired temperature level.
- Wait 6 seconds until the new set temperature stops blinking or press the “OK” button to confirm immediately.



NOTE: The comfort temperature setting must always be higher than the reduced temperature setting. If it is not possible to lower the comfort temperature to the desired value, first set the reduced temperature to an even lower value, or, if it is not possible to increase the reduced temperature to the desired value (maximum 19°C), first increase the comfort temperature.

HOW TO VIEW THE MEASURED ROOM TEMPERATURE



- Press the “OK” button twice. On the first press, the screen will illuminate, and on the second press, the measured room temperature will be displayed together with the room temperature icon , in section 6 of the LCD display.
- The display will return automatically to the active operation mode after 8 seconds.

HEATING

- When the radiator is heating, the , in section 14 of the LCD display, is constantly displayed. As the radiator regulates, the  may not always be displayed due to the required heating demand.

ADVANCED MODE

To gain access to all operating modes, please refer to section 4.0, and set parameter number 01 to "YES".

STAND ALONE RADIATOR

COMFORT MODE

This mode is to be used during periods of normal occupancy.

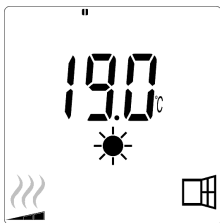

- Default value: 19.0°C

REDUCED MODE (Advanced mode only)

This mode is to be used at night-time or when the house is unoccupied for a few hours or more.



- Default value: 15.5°C

PROGRAM MODE

NOTE: By default, the product will follow the commands of a Touch 4 programmer when set in this mode.

Program d1 must be selected (default).

To enable the product to follow the internal clock, please refer to section 4.0, setting parameter number 10 to "YES" to set the time, and selecting a heating program in parameter number 11.

When you return to the main screen, the selected program and time settings will now be displayed.

To select a heating program, please refer to section 4.0, and select parameter number 11 to view the available heating programs.

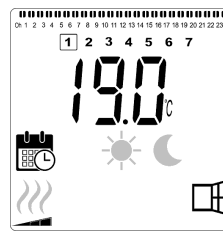

- Default value: 19.0°C

NOTE: If connected to a Unisenza PLUS gateway, it is not possible to set the time.

ANTI-FREEZE MODE (Advanced mode only)

This mode is to be used when the house is unoccupied for extended periods of time.

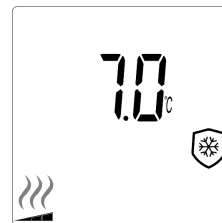

- Default value: 7.0°C

STANDBY MODE (Advanced mode only)

In this mode the radiator is switched off and the word "OFF" will be shown on the LCD display.

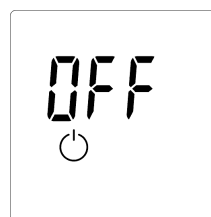

- The radiator will no longer receive signals from a wired external programmer.

- At any time you can check the measured room temperature by pressing the "OK" button.

ATTENTION: Please be aware, if there is no heating in your property then your pipes could freeze. For the protection of product and property in very low temperatures we recommend the "Anti-Freeze" mode is used.

- **ATTENTION:** In this mode the radiators are still connected to the electrical supply.

RADIATOR CONNECTED TO A CENTRAL CONTROL

Rio PLUS electric radiators can be connected to a programmable system by either a Unisenza PLUS Gateway and Unisenza Plus Smartphone app or a Touch 4 programmer. It will not be possible to use both programming systems.

RADIATOR CONNECTED TO A UNISENZA PLUS GATEWAY

WIRELESS RADIO INITIALIZATION (PAIRING)(Picture 7)

Simultaneously press and hold the "<" and ">" keys for 8 seconds until  , in section 11 of the LCD display, and "rF" are displayed on the screen.





Press "OK" to enter this initialization sequence.

The digits will cycle showing that the digital thermostat is waiting for a radio link signal from the gateway to be received (press "<" to cancel radio initialization). When the radio link signal is received, pairing is saved, then it will return to the main screen, but now the cloud and antenna symbols will be displayed.

RADIATOR CONNECTED TO A TOUCH 4 PROGRAMMER

- When connected to a Touch 4 programmer, Program mode must be selected on the radiator so that it follows the orders of the Touch 4 programmer.

NOTE: Preset program d1 must be selected (default) and PROGRAM MODE  must be activated.

-  Comfort mode/temperature is active. The  , in section 7 of the LCD display is displayed.
-  Reduced mode/temperature is active. The  , in section 7, and  , in section 15 of the LCD display are displayed.

NOTE: A suitable means of local isolation of the radiator from both the electrical supply and the pilot wire signal must be provided (picture 4B and 4C)

NOTE: The switched fused spurs must be clearly marked to indicate that two sources of electrical supply may be present.

KEY LOCK FUNCTION

Use the Key Lock function to prevent any changes to your settings (in a child's room, public area... etc)

- To activate the Key Lock function, simultaneously press and hold the "<" , "OK" , and ">" buttons for 10 seconds.
- The key lock  icon, in section 18 of the LCD display, will be displayed on the screen.
- Repeat the same procedure to unlock the keypad. This function is available in all operating modes.

NOTE: When connected to the Unisenza PLUS Gateway, the product can only be locked and unlocked in the App.

BEHAVIOUR INDICATOR

These are the coloured indicators above the LCD display that gives a visual indication of how much energy the current temperature setting is using i.e.



- red = high
- orange = medium
- green = low energy consumption

As you increase the temperature setting, the behavior indicator segments in section 1 of the LCD display, will appear under the orange or red indicators. The opposite applies when decreasing the temperature setting.

NOTE: The behaviour indicator segments are replaced by the program information bar when in Program mode.

You can only view the behaviour indicator when in Comfort mode.

TROUBLE SHOOTING

Displayed icons		
 + 	Sensor problem	Contact the manufacturer or service agent.

4. PARAMETER MENU

The thermostat has a parameter menu. In order to enter this menu, simultaneously press and hold the "<" and ">" keys for 8 seconds until , in section 11 of the LCD display, and "rF" is displayed on the screen.

Parameters can be selected using the left "<" and right ">" navigation buttons. Once the required parameter is displayed, press the "OK" button. Modify the parameter settings with the "+" or "-" buttons and confirm your adjustment with the "OK" button.

To exit the parameter menu, choose the parameter "END" and press the "OK" button.

DEFAULT VALUE & OTHER POSSIBILITIES

00 rF: WIRELESS RADIO INITIALIZATION (PAIRING)

Press "OK" to enter this initialization sequence.

The digits will cycle showing that the digital thermostat is waiting for a radio link signal from the gateway to be received (press "<" to cancel radio initialization). When the radio link signal is received, pairing is saved, then it will return to the main screen, but now the cloud and antenna symbols will be displayed.

01 ALL: EXPERT SETTING

Press "OK" to enter this parameter. Select with "+" or "-" and confirm by pressing the "OK" button:

no: Basic mode (only Program and Comfort modes available).

YES: Advanced mode (all modes available).

NOTE: If connected to a Unisenza PLUS Gateway, this setting will only be available in the App.

02 dEG: TYPE OF DEGREES DISPLAYED

Press "OK" to enter this parameter. Select with "+" or "-" and confirm by pressing the "OK" button:

°C = Celsius

°F = Fahrenheit

NOTE: If connected to a Unisenza PLUS Gateway, this setting will only be available in the App.

03 __. : CALIBRATION OF THE INTERNAL PROBE

The calibration must be done after 1 day working with the same setting temperature in accordance with the following description:

Put a thermometer in the room at 1.5m distance from the floor (like the thermostat) and check the real temperature in the room after 1 hour.

When you enter the calibration parameter screen the actual temperature value is displayed.

To enter the value shown on the thermometer, use the "-" or "+" buttons to enter the real value. At this point the hand  icon, in section 17 of the LCD display, will be displayed and the value will blink. Press the "OK" key to confirm and save. If you need to erase a calibration already saved use the "-" or "+" buttons to alter the value, even just by 0.5°C, then press the left "◀" navigation button. The hand symbol will disappear and the factory calibrated temperature reading will be displayed.

NOTE: Only the heating elements (including follower radiators) managed by the thermostat must be used during the calibration process. Do not have a secondary heat source in the same room for a period of 24 hours before hand.

NOTE: If connected to a Unisenza PLUS Gateway, this setting will only be available in the App.

04 SurF: FRONT PANEL TEMPERATURE

LIMITATION

This power setting can be used to limit the output of the heating element in the front panel and as a consequence will limit the surface temperature of the front panel.

Press "OK" to enter this parameter. Select with "+" or "-" and confirm by pressing the "OK" button:

no = 100% (default)

Mid = 70%

Lo = 55%

NOTE: If connected to a Unisenza PLUS Gateway, this setting will only be available in the App.

NOTE: When considering the permanent use of the radiator at 60°C or 75°C maximum, the following correction factor should be applied for the output.

SETTING	SURFACE TEMPERATURE	SINGLE PANEL	DOUBLE PANEL
no	~ 90°C max	1	1
Mid	~ 75°C max	~ 0.70	~ 0.90
Lo	~ 60°C max	~ 0.55	~ 0.80

E.g. A 1000 Watt double panel programmed for a maximum surface temperature of 60°C will deliver maximum 800 Watts. These values should be considered when selecting the number and type of panels to cover the calculated heat losses.

05 FIRMWARE VERSION

Displays the MCU and Zigbee firmware alternately every 2 seconds.



06 Wind: OPEN WINDOW DETECTION

(the text “Wind” is displayed)

Press the “OK” key to enter this parameter. Select with “+” or “-” and confirm by pressing the “OK” key:

no: open window detection function disabled.

YES: open window detection function enabled (default). The

 , in section 8 of the LCD display, is constantly displayed. This function will switch the radiator from any active mode to “Frost Protection” mode when an open window is detected (room temperature drops within a certain time). The open window icon  will start to blink, and continue to blink as long as the function is active.

To return to the previous or automatic mode, press the “OK” key twice.

NOTE: If connected to a Unisenza PLUS Gateway, this setting will only be available in the App.

07 ItCS: ADAPTIVE START



NOTE: Not used in conjunction with a Touch 4 programmer.

Press the “OK” key to enter this parameter. Select with “+” or “-” and confirm by pressing the “OK” key:

no: adaptive start function disabled. Heating up to reach the Comfort set temperature will start at the programmed time.

YES: adaptive start function enabled (default).

Heating up will start at the predicted optimal time to reach the Comfort set temperature at the programmed time.

The  , in section 5 of the LCD display, is constantly displayed (program mode only). The adaptive start icon  will blink when pre-heating commences.

NOTE: Heating start times will vary for each heating period when this function is enabled.

NOTE: If connected to a Unisenza PLUS Gateway, this setting will only be available in the App.

08 SLA or FOLL: (NOT USED)

Factory set to “no” and must not be altered.

NOTE: If connected to a Unisenza PLUS Gateway, this setting will only be available in the App.

09 CLR: FACTORY SETTING

Press and hold the “OK” key for 6 seconds to reset Set point temperatures and all user parameters in this menu to factory default settings.

NOTE: Pairing with the Unisenza PLUS Gateway will be lost.

The screen will go blank, the LCD screen will illuminate and all segments will be displayed for a few seconds, before displaying the software version. The “Comfort” mode screen will then appear.

10 hour: TIME SETTING

NOTE: If power is lost, from a power cut or the product is switched off, even just for a few seconds, the time and day setting will be lost.

NOTE: If connected to a Unisenza PLUS Gateway, this setting will only be available in the App.

no: time setting disabled (default).

YES: time setting enabled.

- The hour value will blink. Adjust the hour value by pressing the “+” or “-” keys, then confirm by pressing the “OK” key.
- The minute value will blink. Adjust the minute value by pressing the “+” or “-” keys, then confirm by pressing the “OK” key.
- The day values, in section 2 of the LCD display, will blink. Adjust the day value by pressing the “+” or “-” keys, then confirm by pressing the “OK” key.
- The “Comfort” mode or previously selected operating mode screen will appear.

11 prog: SELECT/DEFINE HEATING PROGRAM

NOTE: If connected to a Unisenza PLUS Gateway, this setting will only be available in the App.

SELECTING A PROGRAM

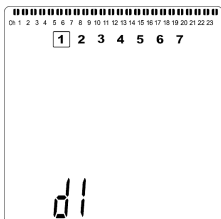

- Use the “+” or “-” keys to select one of the preset programs, d1 to d9 (picture 6), or one of the user definable programs, U1 to U4. The program number will blink. The heating schedule for the current day is displayed along the top of the LCD screen.
- To view the heating schedule for the other days, press the “<” or “>” keys. Press the “OK” key to confirm the program to be followed.

DEFINING A USER PROGRAM

NOTE: Once saved, the user defined programs are not lost in the event of a power cut. However, the time will reset to 00:00 and day 1 when the power returns, if not set, so the product may not heat at the expected times.

NOTE: If a user defined program has already been created and saved, it will be overwritten when the newly defined user program is saved.

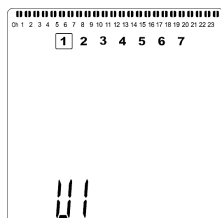

- Use the “+” or “-” keys to select a user definable program, U1 to U4, to be modified, then press and hold the “OK” key for 3 seconds.

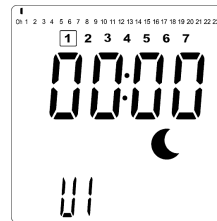

- The above screen will be shown, where the ☾ symbol, the time value 00:00, and the time segment in the program information bar along the bottom of the screen will blink continuously.



- Use the “+” or “-” keys to adjust the time at which the first Reduced period will end.
- As the time indexes, the blinking segment on the program information bar will move horizontally along the time scale according to the time value.



- Press the “OK” key to confirm the time at which the mode will change over from Reduced to Comfort. The ☀ symbol will start to blink instead of the ☾ symbol, signifying the start of this Comfort period.



- Use the “+” and “-” keys to adjust the time at which the first Comfort period will end. The segments in the program information bar will populate to show the Comfort period.

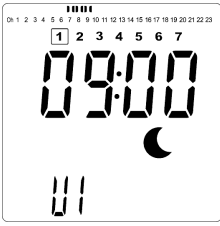

- Press the “OK” key to confirm the time at which the mode will change over from Comfort to Reduced. The ☾ symbol will start to blink instead of the ☀ symbol, signifying the start of this Reduced period.

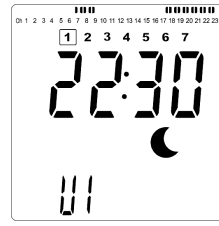

- Press the “OK” key to confirm the time at which the mode will change over from Comfort to Reduced. The ☾ symbol will start to blink instead of the ☀ symbol, signifying the start of this Reduced period.
- If more than two Comfort periods are required, repeat the previous steps.

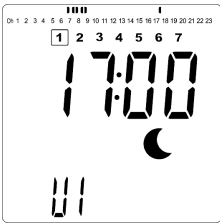

- Use the “+” and “-” keys to adjust the time at which this Reduced period will end.



- When all Comfort periods have been defined, use the “+” key to advance beyond the time “23:30”. The above screen will then be shown, asking if the program that has just been defined for that day is to be copied to the next day.
- To copy the program onto the next day, press the “OK” key. Press the “OK” key for any further days the program is to be copied over to.

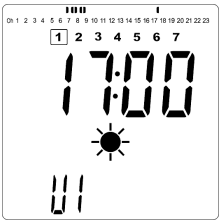

- Press the “OK” key to confirm the time at which the mode will change over from Reduced to Comfort. The ☀ symbol will start to blink instead of the ☾ symbol, signifying the start of this Comfort period.

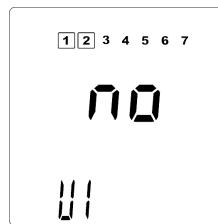

- If a different program is to be defined for the next day, press the “+” or “-” key until the word “no” is displayed. Press the “OK” key to confirm.



- Use the “+” and “-” keys to adjust the time at which this Reduced period will end. The segments in the program information bar will populate to show the Comfort period.

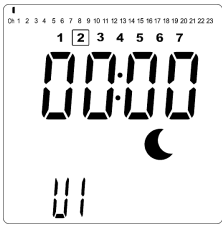

- The day number will increment to the next day and the time will be set back to “00:00”.



- When all of the days have been defined, the word “SAVE” will be displayed. To save the program, press the “OK” key to confirm.
- If the program is not to be saved, so that any previously user defined program is not overwritten, press the left “◀” arrow key. The screen will revert back to the Program Selection screen.

13 MAC: ZIGBEE MODULE MAC ADDRESS

Press “OK” to enter this parameter. The 16 digits of the MAC address will be displayed, 4 digits at a time. Each of the 4 digits will be displayed for 3 seconds.

14 Code: ZIGBEE MODULE INSTALLATION CODE

Press “OK” to enter this parameter. The 32 digits of the installation code will be displayed, 4 digits at a time. Each of the 4 digits will be displayed for 3 seconds.

15 RES: NOT USED

19 End: EXIT THE PARAMETER MENU

Press the “OK” key to exit installation parameter menu and return to normal operation.

5. MAINTENANCE, REPAIR AND DISPOSAL

- **WARNING:** Disconnect electrical supply before carrying out any maintenance activity.
- The product should be cleaned using a soft damp cloth. Do NOT use chemical or abrasive cleaners as they will damage the surface finish.
- The radiator is equipped with overheat protection that cannot be reset (melt fuse). This overheat protection disconnects the current if the radiator becomes too hot (e.g. when covered).
- If the supply cord is damaged, it must be replaced by the manufacturer, a service agent or similar qualified persons in order to avoid a hazard.
- The radiator is filled with an exact amount of environmental friendly vegetable oil. Any repairs that require the radiator to be opened shall therefore only be carried out by the manufacturer or an approved agent.
- In case of leakage contact the manufacturer or service agent.
- When the radiator reaches the end of its service life follow the regulations concerning the disposal of oil.

6. WARRANTY

The product is covered by a 10 years warranty except for the electrical and electronic components that are covered by a 2 year warranty.

7. TECHNICAL CHARACTERISTICS

ENVIRONMENTAL: - Operating temperature - Storage temperature	-30°C to +50°C -30°C to +70°C
SETTING TEMPERATURE RANGE - Comfort mode - Reduced mode - Frost protection mode	+5.5°C to +30.0°C, must be higher than the reduced mode setting. +5.0°C to +19.0°C, must be lower than the comfort mode setting. +5.0°C to +10.0°C.
ELECTRICAL INSULATION	Class I
ELECTRICAL PROTECTION	IP44
IMPACT PROTECTION	IK08
POWER SUPPLY	230 VAC – 50 Hz
DIRECTIVES & STANDARDS: The product has been designed to comply with the following Directives and Standards.	<ul style="list-style-type: none"> • EN 60730-1 • EN 60335-1 • EN 60335-2-30 • EN 62233 • EN 55014-1 • EN 55014-2 • EN 61000-3-2 • EN 61000-3-3 • EN 60529 • LV Directive 2014/35/EU • EMC Directive 2014/30/EU • RED Directive 2014/53/EU • RoHS Directive 2011/65/EU • ECO Directive 2024/1103 • REACH Regulation 1907/2006/EU

Contact details		Purmo Group (UK) Ltd, Eastern Avenue, Team Valley, Gateshead, Tyne and Wear, NE11 0PG, UK				
Model identifier(s):		RIO D xxxxxx Z	RIO P xxxxxx Z	RIO L xxxxxx Z		
Item	Symbol	Value	Unit	Item	Unit	
Heat output				Type of heat output/room temperature control		
Nominal heat output where	"xxxxxx" = 30DX50 or 50DX40	P_{nom}	0.500	kW	single stage heat output and no room temperature control	no
	"xxxxxx" = 30DX80 or 50DX50	P_{nom}	0.750	kW	two or more manual stages, no room temperature control	no
	"xxxxxx" = 30DX100 or 50DX65	P_{nom}	1.000	kW	with mechanic thermostat room temperature control	no
	"xxxxxx" = 30DX130 or 50DX80	P_{nom}	1.250	kW	with electronic room temperature control	no
	"xxxxxx" = 30DX160 or 50DX95	P_{nom}	1.500	kW	electronic room temperature control plus day timer	no
	"xxxxxx" = 30DX200 or 50DX125	P_{nom}	2.000	kW	electronic room temperature control plus week timer	yes
Minimum heat output (indicative)		P_{min}	N.A.	kW	Other control options	
Maximum continuous heat output	"xxxxxx" = 30DX50 or 50DX40	$P_{max,c}$	0.500	kW	room temperature control, with presence detection	no
	"xxxxxx" = 30DX80 or 50DX50	$P_{max,c}$	0.750	kW	room temperature control, with open window detection	yes
	"xxxxxx" = 30DX100 or 50DX65	$P_{max,c}$	1.000	kW	distance control option	yes
	"xxxxxx" = 30DX130 or 50DX80	$P_{max,c}$	1.250	kW	adaptive start control	yes
	"xxxxxx" = 30DX160 or 50DX95	$P_{max,c}$	1.500	kW	working time limitation	no
	"xxxxxx" = 30DX200 or 50DX125	$P_{max,c}$	2.000	kW	black bulb sensor	no
Power consumption				self-learning functionality		no
In off mode		P_o	0.00	W	control accuracy	yes
In standby mode		P_{sm}	0.22	W		
In idle mode		P_{idle}	0.22	W		
In network standby		P_{nsm}	0.23	W		
Standby mode with display of information or status			yes			
Seasonal space heating energy efficiency in active mode		$\eta_{s,on}$	98.0	%		

Purmo Group UK Ltd

Eastern Avenue, Team Valley
Gateshead, Tyne & Wear
NE11 0PG, UK

T: 0330 041 5474

F: 0191 491 7568

generalenquiries.uk@purmogroup.com

www.myson.co.uk

Purmo Group

Bulevardi 46
P.O. Box 115
FI-00121 Helsinki, Finland

P24MI539 ver8

