

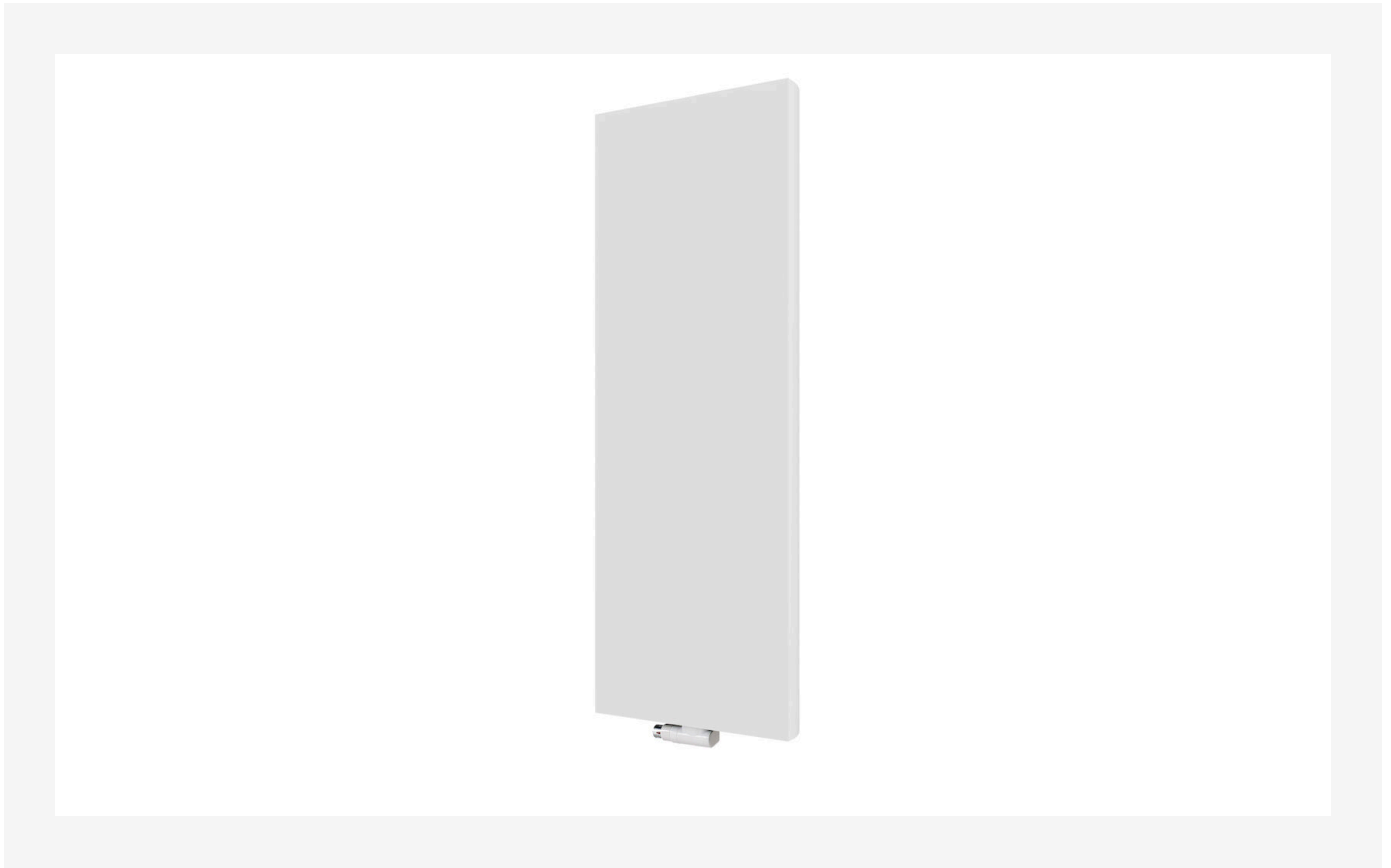

Andmeleht
2026-06-07

Kos V

Kaasaegne, minimalistlik elegants.



- ✓ Elegantne, modernne disain
- ✓ Sobib piiratud seinaruumile
- ✓ Kõrgekvaliteediline roostevabast terasest rätikuhoidja
- ✓ Saadaval mitmes värvitoonis
- ✓ Sobib interjööri

Kos V vertikaalradiator täiuslikult sileda esipaneeli ja pehmete servadega pakub puhast, kaasaegset esteetikat ja sobib suurepäraselt kitsastele seintele; saadaval RAL toonides ja roostevabast terasest versioonina.



Kasutusala

Kos V sobib elu- ja äripindadele, eriti kohtadesse, kus seinaruumi on vähe. See on kaasaegne alternatiiv horisontaalsetele radiaatoritele, varustatud sileda terasest esipaneeli, külgpaneelide ja ülemise restiga. Sobib kahetorusüsteemidele koos tsirkulatsioonipumbaga.

Möödistamine

Õige tootevaliku tagamiseks kasutage meie kalkulaatoreid ja tootekatalooge. Kui vajate abi, võtke ühendust meie müügimeeskonnaga.

Kasutamine

Paigalda radiaator kaasasolevate reguleeritavate seinakronsteinidega, veendudes, et ühendused sobivad neljale 1/2-tollisele keermestatud sisendile; pärast paigaldust täida süsteem veega ja õhuta seda 1/4-tollise õhutuskraani abil, kontrolli regulaarselt ühendusi ja puhasta pinda pehme, mitteabrasiivse lapiga.

AMA-tekst

Kos V vertikaalne radiaator sileda esipaneeli ja ümardatud servadega, sobib kitsastele seintele ja modernsetesse ruumidesse. Saadaval erinevad RAL toonid ja roostevabast terasest versioon. Sobib köökidesse ja vannitubadesse; saadaval roostevabast terasest rätikuriul. Komplektis kinnitused, paigalduskomplekt, korgid ja õhutusventiil. Standardvärv RAL 9016.



Spetsifikatsioonid

OMADUSED	ÜHIK	VÄÄRTUSED
ETIM-klass		EC011022
Materjal		Terase
Tüüp		20, 21, 22
Pinnastruktuur		Sile tasane
Maksimaalne töö rõhk	bar	10
Standardühenduste arv		4
Soojusandmine vastavalt EN 442 tunnustatud laborile		Jah
Maksimaalne töötemperatuur	°C	110
Standardvärv		Jah
Värv		Valge
RAL-number		9016
Rest/Katteplaat		Jah
Rest/Katteplaat		Jah
Läikeväärtus		Särav
Keerme mõõt (toll)		1/2 tolli
Ühenduskeere		Sisemine keere
Ühepunktiühendusega		Jah
Õhutusühendusega		Jah
Õhutusventiili/õhutusavaga		Jah
Tühjendusvõimalusega		Jah



Ressursid

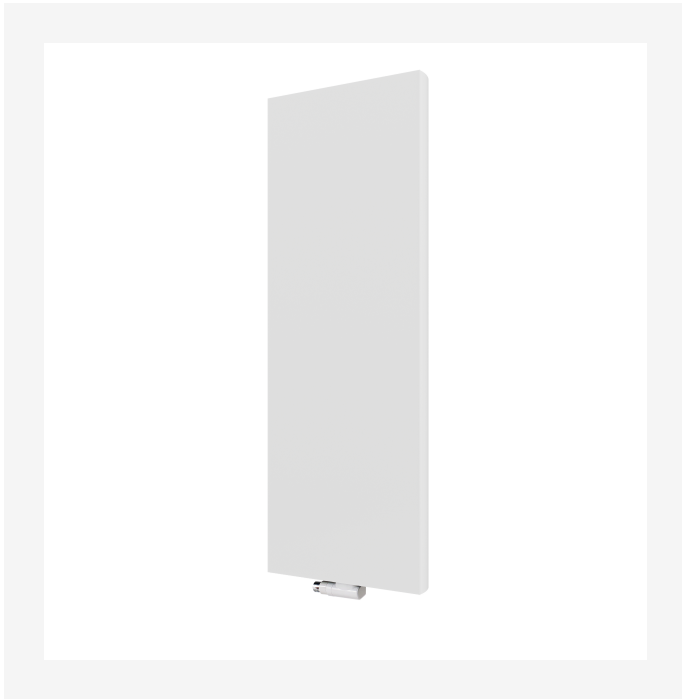

ProductImage - New_Kos-V main image



ProductImage - Vertical design radiator Kos V, KOV, 30 degree, white 3D product image.

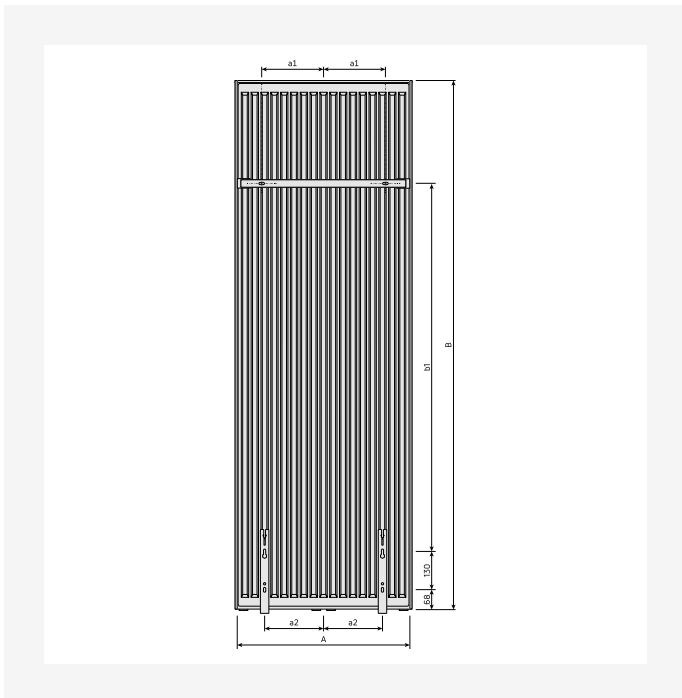

DimensionalDrawing - Kos V / Faro V, tagantvaade

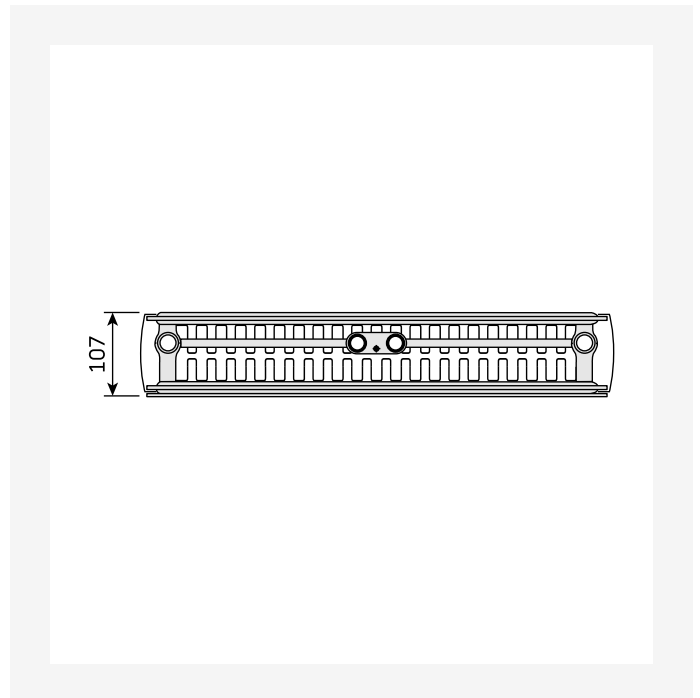

DimensionalDrawing - Kos V / Faro V, tüüp 22, pealtvaade



Ressursid

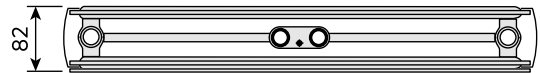
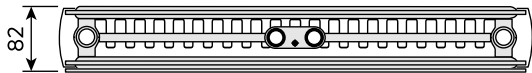

DimensionalDrawing - Kos V / Faro V, tüüp 21, pealtvaade

DimensionalDrawing - Kos V / Faro V, tüüp 20, pealtvaade

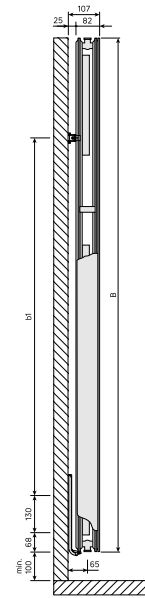
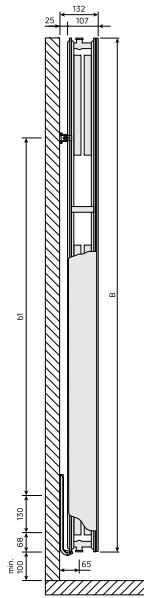

DimensionalDrawing - Kos V / Faro V, tüüp 22, külgsaade

DimensionalDrawing - Kos V / Faro V, tüüp 21, külgsaade



Ressursid

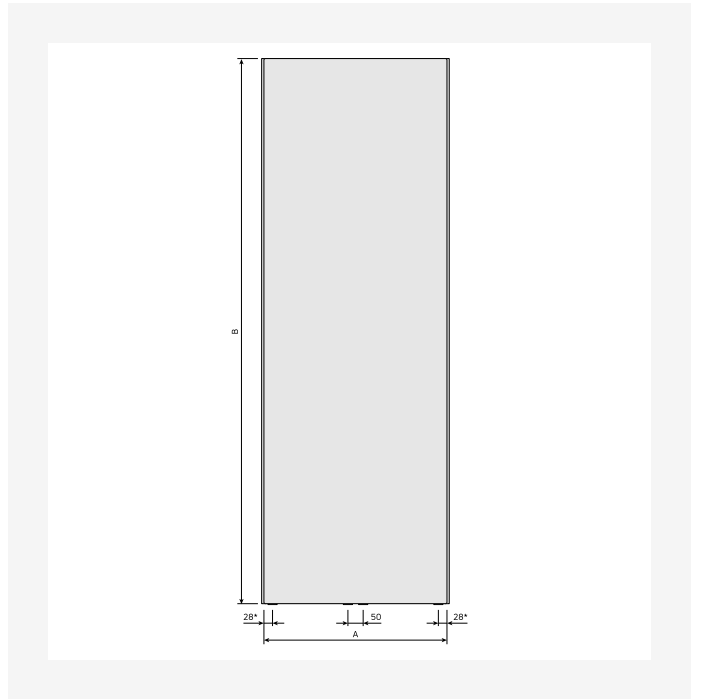
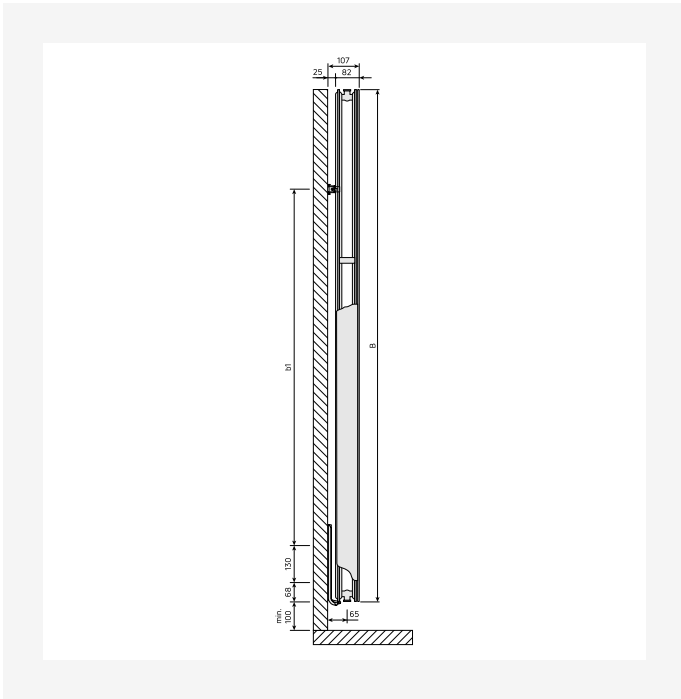

DimensionalDrawing - Kos V / Faro V, tüüp 20, külgsaade

DimensionalDrawing - Kos V, eestvaade

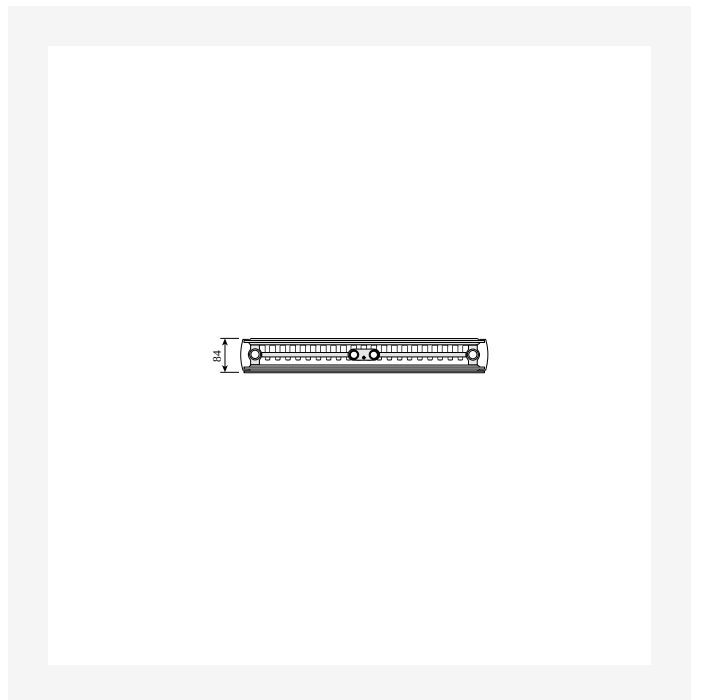
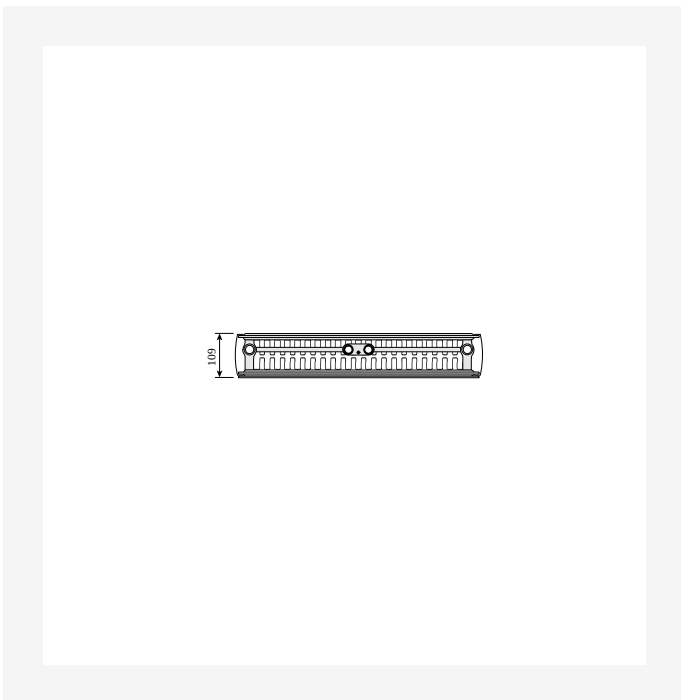

DimensionalDrawing - Kos V ja Faro V, tüüp 22, pealtvaade

DimensionalDrawing - Kos V ja Faro V, tüüp 21, pealtvaade



Ressursid

KOS V (mm)				
A	320	470	620	770
a1	60	135	210	285
a2	75	125	200	250

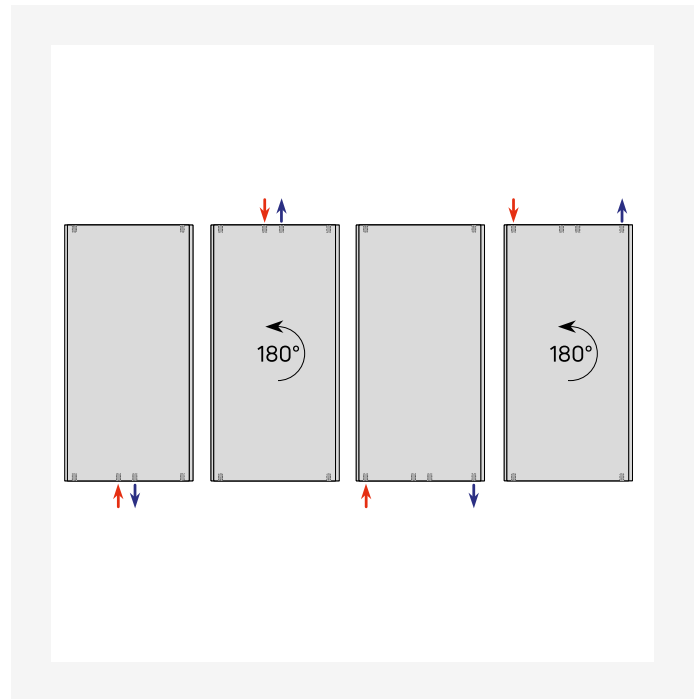

DimensionalDrawing - Kos V, Faro V, tabel A

DimensionalDrawing - Vertikaalsed ühendusvariandid

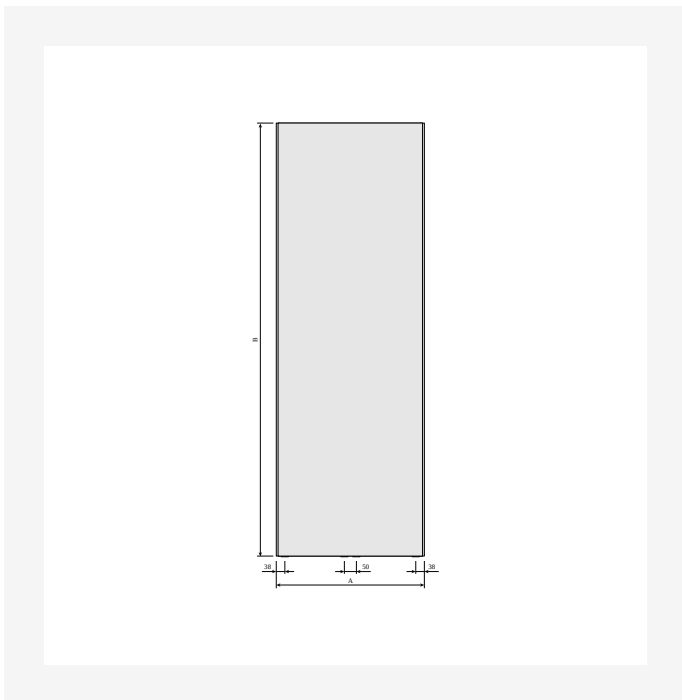

DimensionalDrawing - Kos V, eestvaade

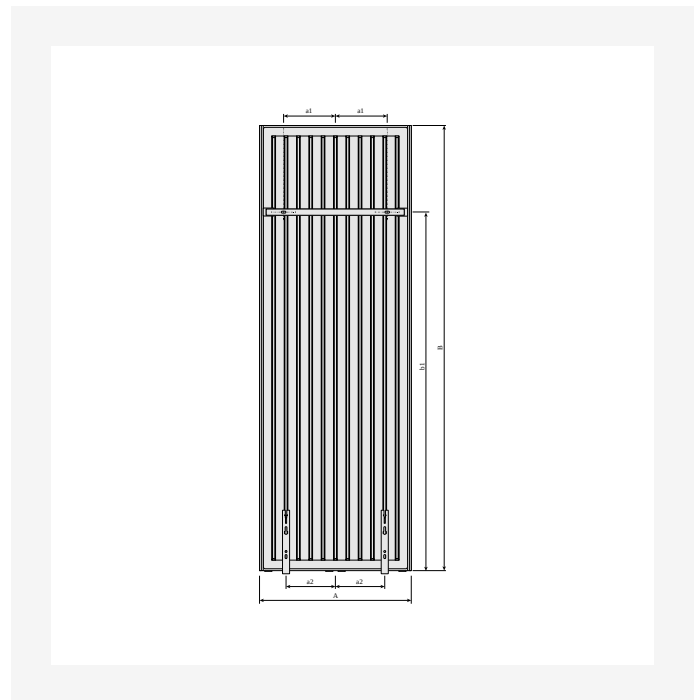

DimensionalDrawing - Kos V ja Faro V MCWV seinakanduritega, tagantvaade



Ressursid

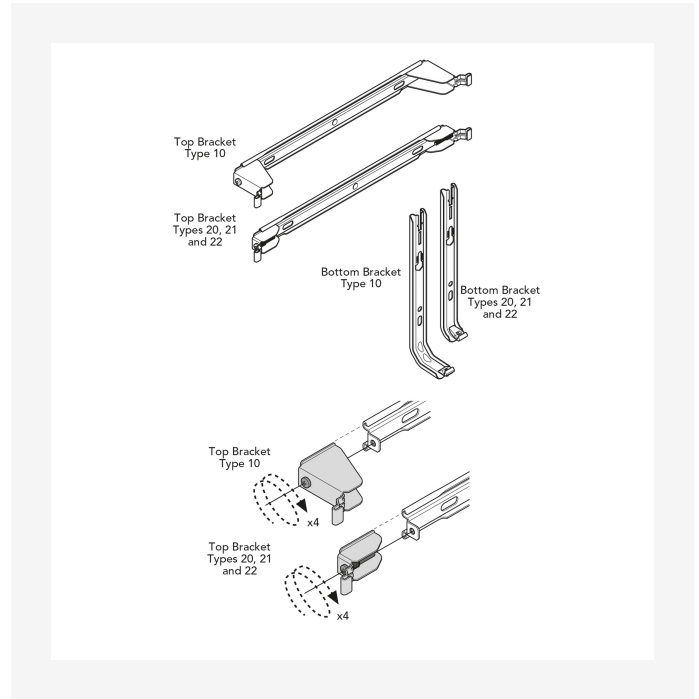
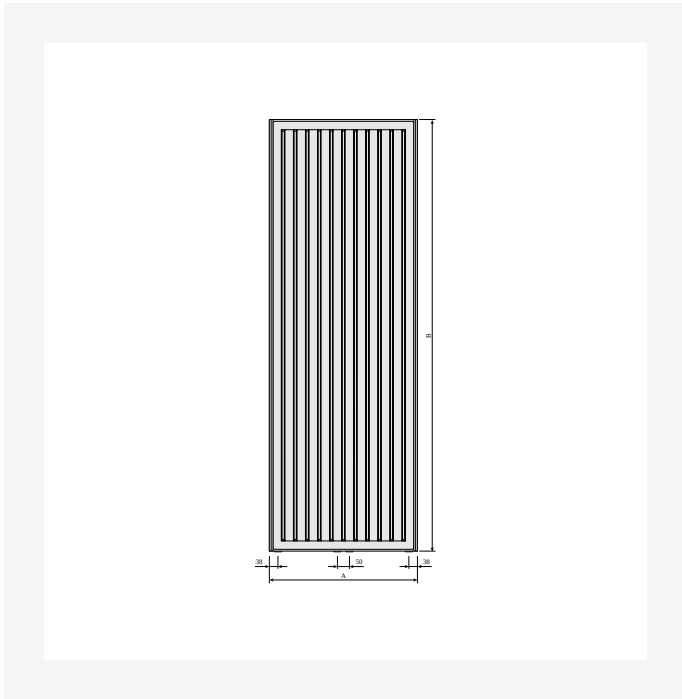

Dimensional Drawing - Kos V ja Faro V, tagantvaade

Dimensional Drawing - Purmo Vertical, Plan & Plan Plus Vertical kinnitused

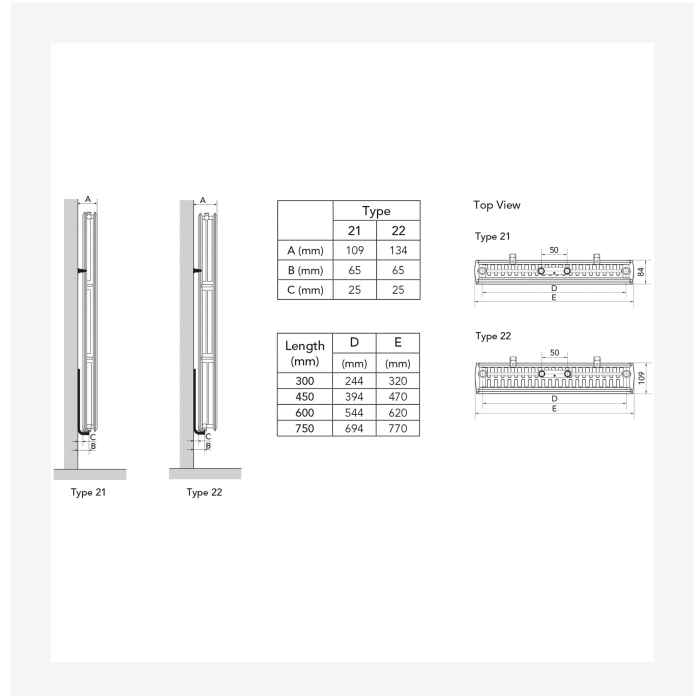
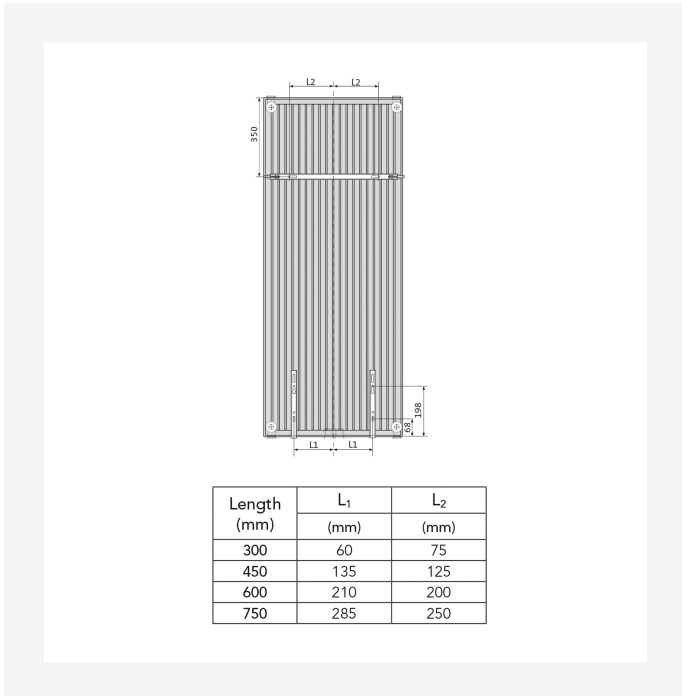

Dimensional Drawing - Purmo Vertical Plan & Plan Plus Vertical – kinnituspunktid ja mõõdud

Dimensional Drawing - Purmo Plan & Plan Plus Vertical – paigalduspositsioonid ja mõõdud



Ressursid

KOS V (mm)			
B	1800	1950	2100
b1	1450	1600	1750
b2	1252	1402	1552

KOS V (mm)				
B	1500	1800	1950	2100
b1	1150	1450	1600	1750
b2	952	1252	1402	1552

DimensionalDrawing - Kos V, Faro V – tabel B – PL

DimensionalDrawing - Kos V, Faro V – tabel B



Seotud tooted



Plan Compact (FC)



Rätikuhoidja Vertical

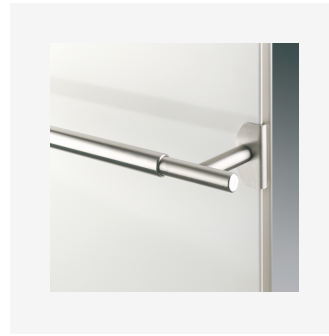

Rätikuhoidja Kos V / Faro V



Õhutuvõti



Küljepaneel Kos V/Faro V



Parandussvärvi spreii



1500

KÕRGUS 1500 mm	PIKKUS	SÜGAVUS	Võimsus (W) 45/35/20°C	Võimsus (W) 55/45/20°C	Võimsus (W) 60/45/20°C	MAHT (l)	N- ekponent	KAAL (kg)	
Tüüp 21									
	300	82	FMX2115003011300	252	436	--	4.0	1.30	27.3
	450	82	FMX2115004511300	366	634	--	6.1	1.30	39.2
	600	82	FMX2115006011300	476	826	--	8.2	1.30	51.1
	750	82	FMX2115007511300	--	1014	--	10.3	1.30	63.0
Tüüp 22									
	300	107	FMX2215003011300	300	521	--	4.0	1.31	29.8
	450	107	FMX2215004511300	442	769	--	6.2	1.31	43.1
	600	107	FMX2215006011300	581	1014	--	8.3	1.31	56.5
	750	107	FMX2215007511300	--	1255	--	10.3	1.32	69.8



1800

KÕRGUS 1800 mm	PIKKUS	SÜGAVUS	Võimsus (W) 45/35/20°C	Võimsus (W) 55/45/20°C	Võimsus (W) 60/45/20°C	MAHT (l)	N- ekponent	KAAL (kg)
Tüüp 20								
300	82	FMX2018003011300	429	459	--	4.8	1.28	30.1
450	82	FMX2018004511300	382	657	--	7.2	1.28	42.9
600	82	FMX2018006011300	491	847	--	9.7	1.29	55.6
750	82	FMX2018007511300	--	1031	--	12.1	1.29	0.0
Tüüp 21								
300	82	FMX2118003011300	286	495	536	4.8	1.29	31.7
450	82	FMX2118004511300	414	716	776	7.2	1.30	45.8
600	82	FMX2118006011300	535	930	1008	9.7	1.31	59.9
750	82	FMX2118007511300	653	1139	1235	12.1	1.31	74.0
Tüüp 22								
300	107	FMX2218003011300	342	592	--	4.8	1.30	35.1
450	107	FMX2218004511300	503	873	--	7.3	1.30	50.6
600	107	FMX2218006011300	660	1149	--	9.7	1.31	66.1
750	107	FMX2218007511300	815	1421	--	12.2	1.31	79.8



1950

KÕRGUS 1950 mm	PIKKUS	SÜGAVUS	Võimsus (W) 45/35/20°C	Võimsus (W) 55/45/20°C	Võimsus (W) 60/45/20°C	MAHT (l)	N- ekponent	KAAL (kg)	
Tüüp 20									
	300	82	FMX2019503011300	463	495	--	5.2	1.28	32.5
	450	82	FMX2019504511300	412	709	--	7.8	1.28	45.9
	600	82	FMX2019506011300	836	914	--	10.4	1.29	59.3
	750	82	FMX2019507511300	645	1113	--	13.0	1.29	72.8
Tüüp 21									
	300	82	FMX2119503011300	302	521	565	5.2	1.29	34.1
	450	82	FMX2119504511300	437	756	820	7.8	1.30	49.3
	600	82	FMX2119506011300	568	985	1067	10.4	1.30	64.4
	750	82	FMX2119507511300	694	1207	1308	13.0	1.31	79.6
Tüüp 22									
	300	107	FMX2219503011300	361	624	--	5.3	1.29	37.3
	450	107	FMX2219504511300	532	922	--	7.8	1.30	53.8
	600	107	FMX2219506011300	698	1213	--	10.4	1.30	70.3
	750	107	FMX2219507511300	861	1500	--	13.1	1.31	85.9



2100

KÕRGUS 2100 mm	PIKKUS	SÜGAVUS	Võimsus (W) 45/35/20°C	Võimsus (W) 55/45/20°C	Võimsus (W) 60/45/20°C	MAHT (l)	N- ekponent	KAAL (kg)
Tüüp 20								
300	82	FMX2021003011300	311	532	--	5.6	1.27	34.8
450	82	FMX2021004511300	443	761	--	8.4	1.27	49.8
600	82	FMX2021006011300	902	980	--	11.1	1.28	64.8
750	82	FMX2021007511300	690	1191	--	13.9	1.29	79.8
Tüüp 21								
300	82	FMX2121003011300	315	548	593	5.6	1.29	36.5
450	82	FMX2121004511300	460	796	862	8.4	1.29	52.7
600	82	FMX2121006011300	600	1038	1125	11.1	1.30	69.0
750	82	FMX2121007511300	737	1276	1382	13.9	1.30	85.2
Tüüp 22								
300	107	FMX2221003011300	380	655	--	5.7	1.29	40.4
450	107	FMX2221004511300	559	967	--	8.4	1.29	58.0
600	107	FMX2221006011300	734	1273	--	11.2	1.30	75.6
750	107	FMX2221007511300	1372	1574	--	13.9	1.30	92.3