

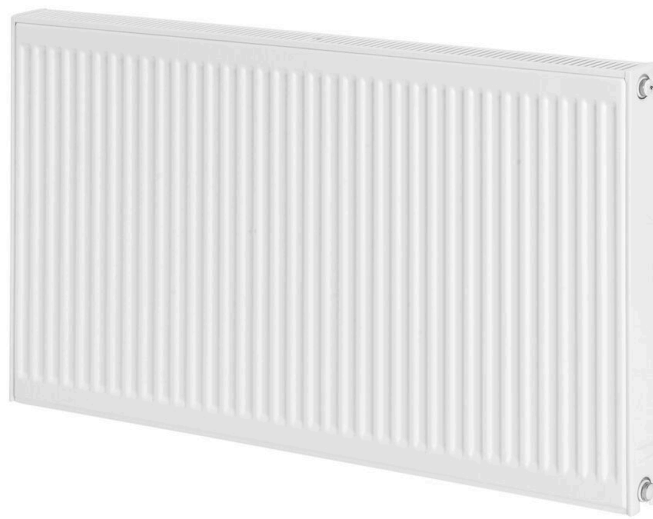

Andmeleht
2026-05-23

Compact ©

Kõrgekvaliteediline klassikaline paneelradiaator külgühendusega.



- ✓ Kõrge rõhukindlus
- ✓ Esteetiline välimus
- ✓ Paindlik paigaldus
- ✓ Ühtlane soojusjaotus
- ✓ Lai värvivalik

Compact on klassikaline paneelradiaator universaalse disainiga ja laias moodsuselikus; külpaneelidega, ülemise restiga, lasteohutuskinnitustega, saadaval RAL 9016 ja muudes toonides.



Kasutusala

Purmo Compact radiaator sobib eluruumidesse ja äripindadele, kus on nõutud tööõhk kuni 10 bar. Ideaalne kõrghoonetele, tsentraalküttesüsteemidele ja suurtele paigaldustele. Maksimaalne töökõrgtemperatuur kuni 110 °C. Radiaatoril on vertikaalsed veekanalid 33,3 mm sammuga tõhusaks soojusjaotuseks.

Möödistamine

Õige tootevaliku tagamiseks kasutage meie kalkulaatoreid ja tootekatalooge. Kui vajate abi, võtke ühendust meie müügimeeskonnaga.

Kasutamine

Radiaatori paigalda MCW-7 seinakronsteinidega stabiilsuse tagamiseks, ühenda süsteemiga nelja külge G 1/2" ühenduse kaudu, tee regulaarset hooldust ja järgi kuni 10 bar rõhu ning 110°C temperatuuri piire.

AMA-tekst

Compact radiaator mõeldud kõrgsurve küttesüsteemidele, tööõhk kuni 10 bar ja temperatuur kuni 110°C. Valmistatud PN-EN 10130 külmaaltsitud terasest. Konstruktsioonis 33,3 mm sammuga vertikaalkanaleid, külgpaneelid ja ülemine rest. Ühendused: 4×G 1/2". Komplektis seinakinnitused, korgid ja õhutusventiil. Standardtoon RAL 9016; muud toonid tellimisel.



Spetsifikatsioonid

OMADUSED	ÜHIK	VÄÄRTUSED
ETIM-klass		EC011022
Materjal		Terase
Tüüp		11, 21, 22, 33
Pinnastruktuur		Profiilitud
Maksimaalne töö rõhk	bar	10
Standardühenduste arv		4
Soojusandmine vastavalt EN 442 tunnustatud laborile		Jah
Maksimaalne töötemperatuur	°C	110
Standardvärv		Jah
Värv		Valge
RAL-number		9016
Rest/Katteplaat		Jah
Rest/Katteplaat		Jah
Läikeväärtus		Särav
Keerme mõõt (toll)		1/2 tolli
Ühenduskeere		Sisemine keere
Ühepunktiühendusega		Jah
Õhutusühendusega		Jah
Õhutusventiili/õhutusavaga		Jah
Tühjendusvõimalusega		Jah



Ressursid



ProductImage - Purmo Compact, C, product image 30 degrees.



DimensionalDrawing - Radaatori kinnitamise juhend

COMPACT (mm)				
	C11		C21s, C22, C33	
A	a1	a2	a1	a2
400-1600	117	-	133	-
1800	117	917	133	900
2000	117	1017	133	1000
2300	117	1150	133	1167
2600	117	1317	133	1300
3000	117	1517	133	1500

DimensionalDrawing - Compact, tabelijoonis A

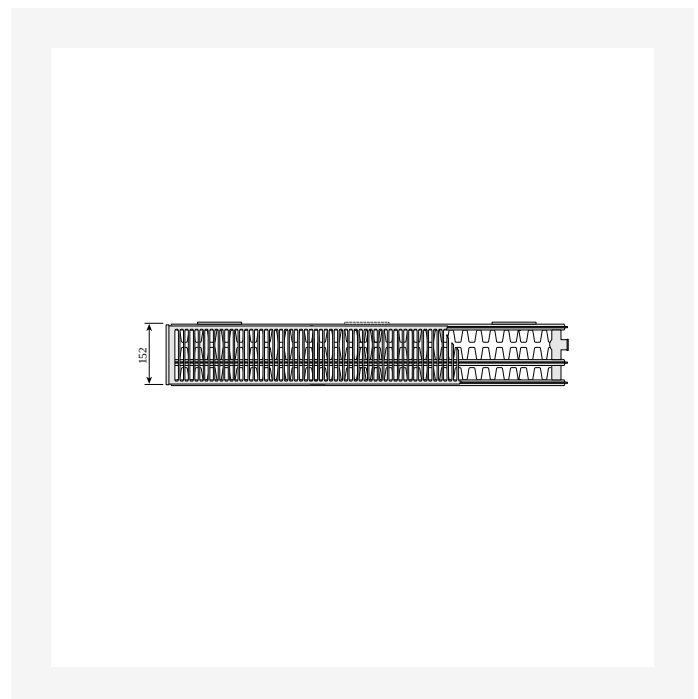

DimensionalDrawing - Compact, tüüp 33, pealtvaade



Ressursid

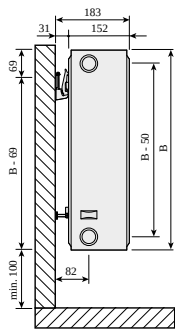

DimensionalDrawing - Compact, tüüp 33, külgaade SSMS seinakanduritega

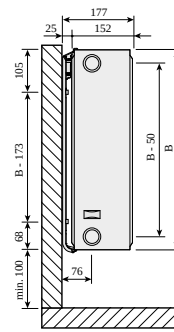

DimensionalDrawing - Compact, tüüp 33, külgaade Monclac seinakanduritega



DimensionalDrawing - Compact, tüüp 22, pealtvaade

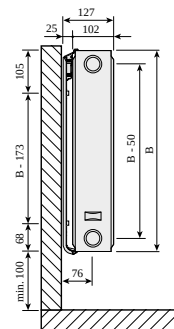

DimensionalDrawing - Compact, tüüp 22, külgaade Monclac seinakanduritega



Ressursid

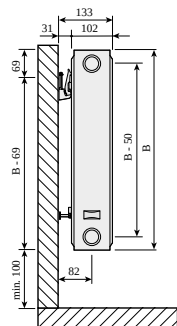

DimensionalDrawing - Compact, tüüp 22, külgvaade SSMS seinakanduritega

DimensionalDrawing - Compact, tüüp 21, pealtvaade

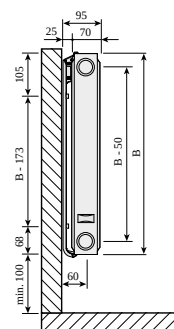
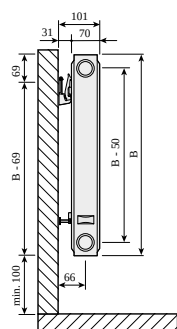

DimensionalDrawing - Compact, tüüp 21, külgvaade SSMS seinakanduritega

DimensionalDrawing - Compact, tüüp 21, külgvaade Monclac seinakanduritega



Ressursid

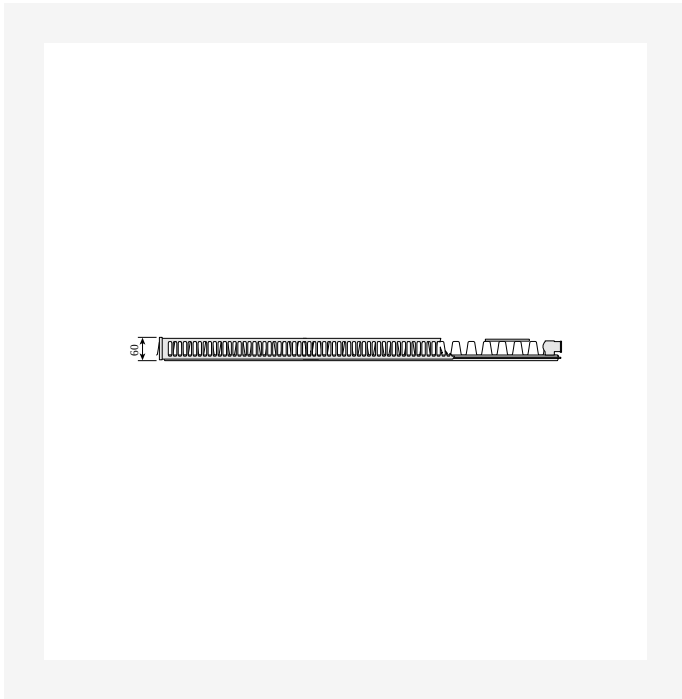

DimensionalDrawing - Compact, tüüp 11, pealtvaade

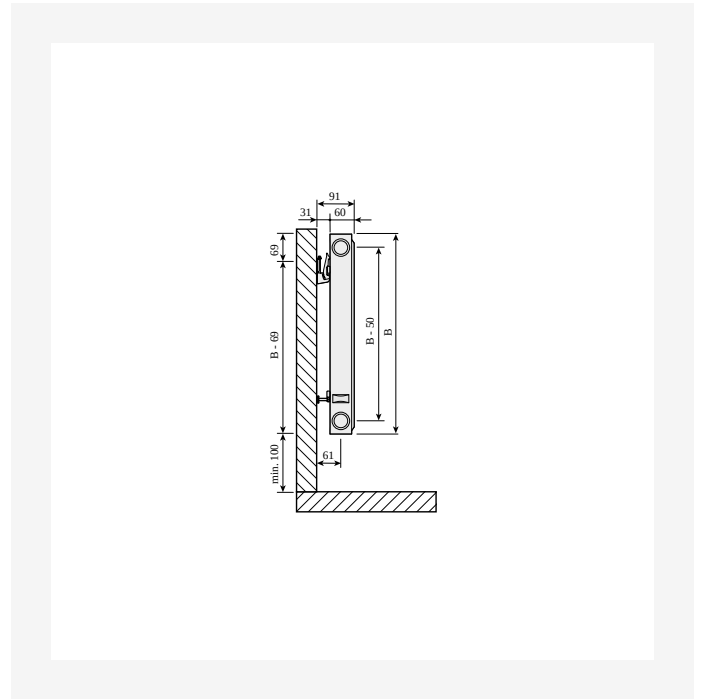

DimensionalDrawing - Compact, tüüp 11, külgsaade SSMS seinakanduritega

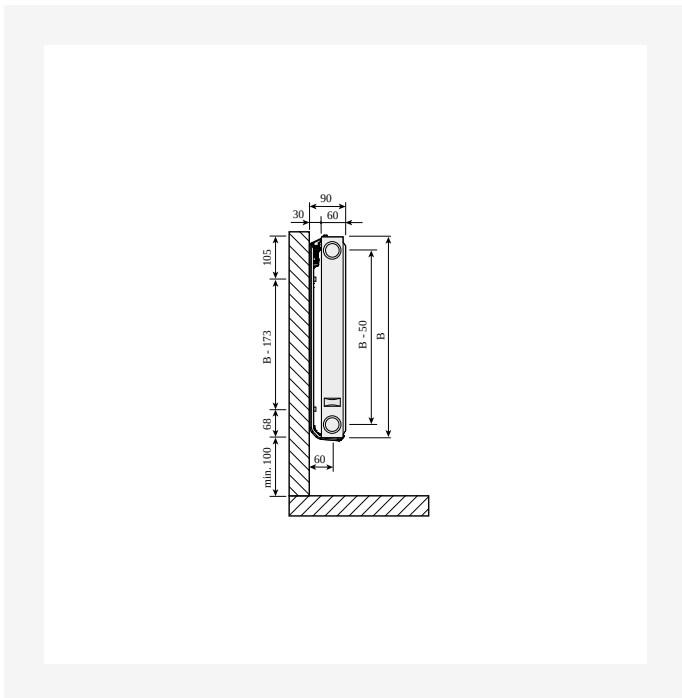

DimensionalDrawing - Compact, tüüp 11, külgsaade Monclac seinakanduritega

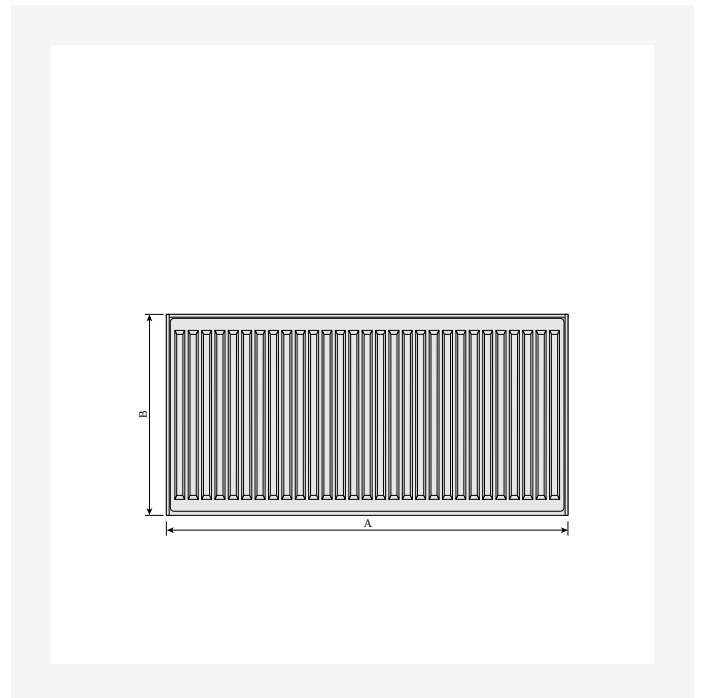

DimensionalDrawing - Compact, eestvaade



Ressursid

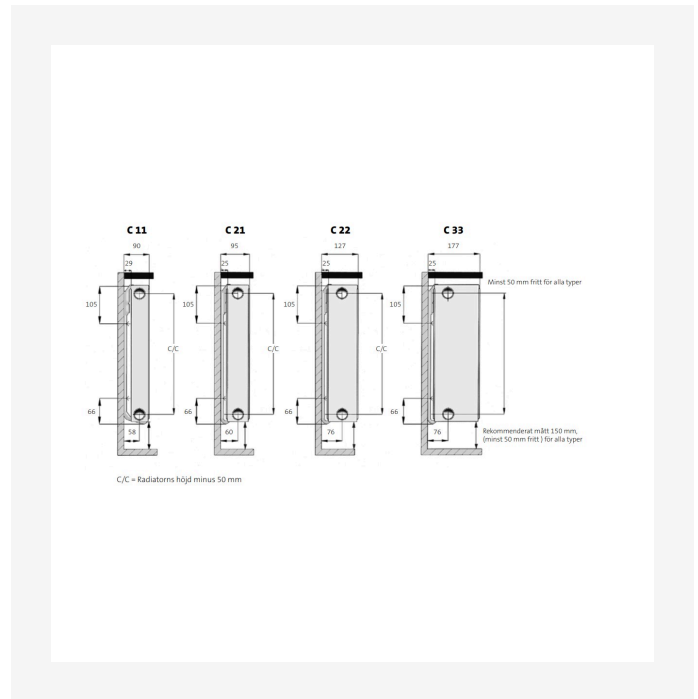
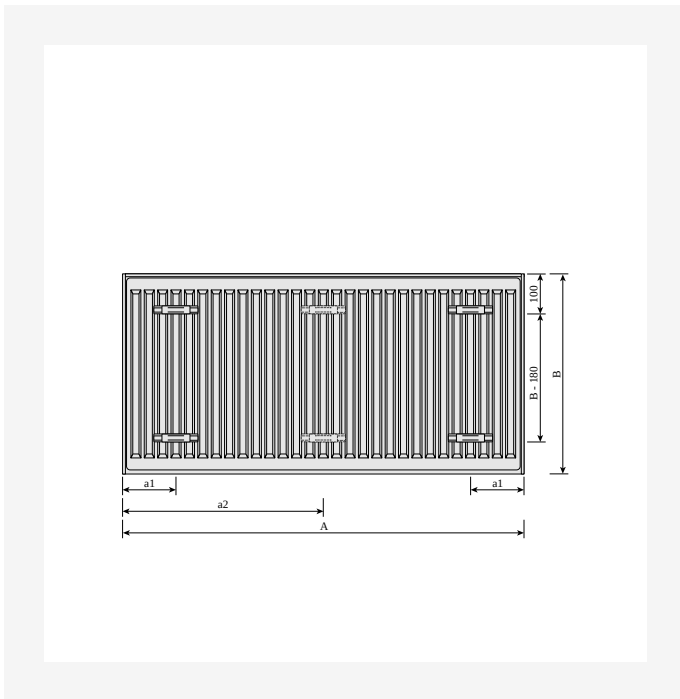

DimensionalDrawing - Compact, tagantvaade

DimensionalDrawing - Paigaldusmõõdud

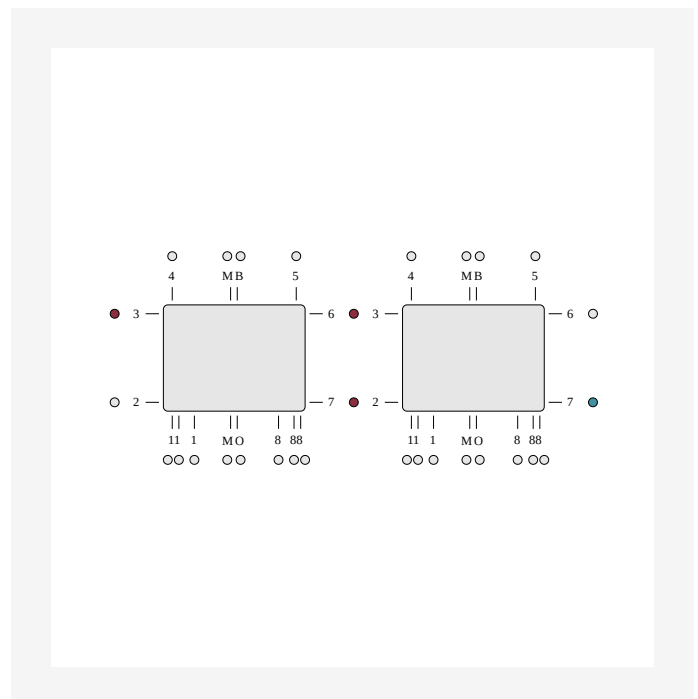
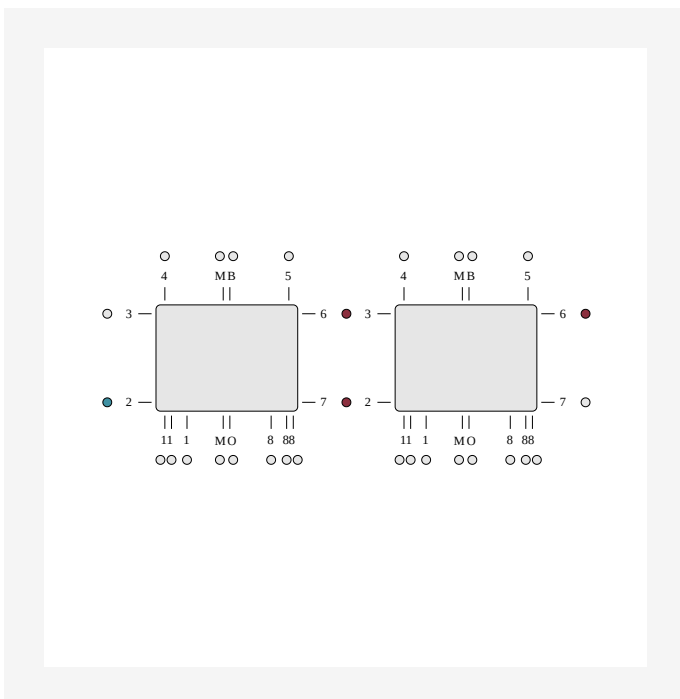

DimensionalDrawing - ETIM 62 seeria horisontaalne ühendus

DimensionalDrawing - ETIM 37 seeria horisontaalne ühendus



Ressursid

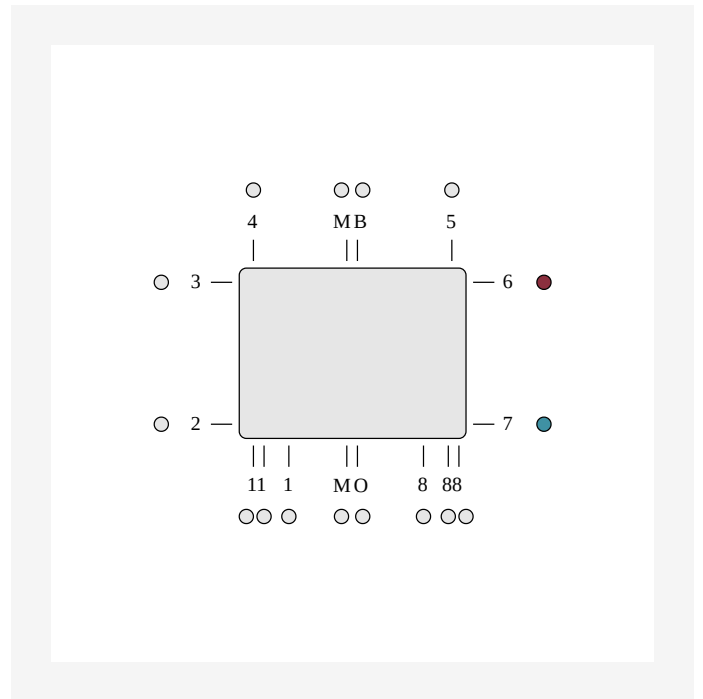
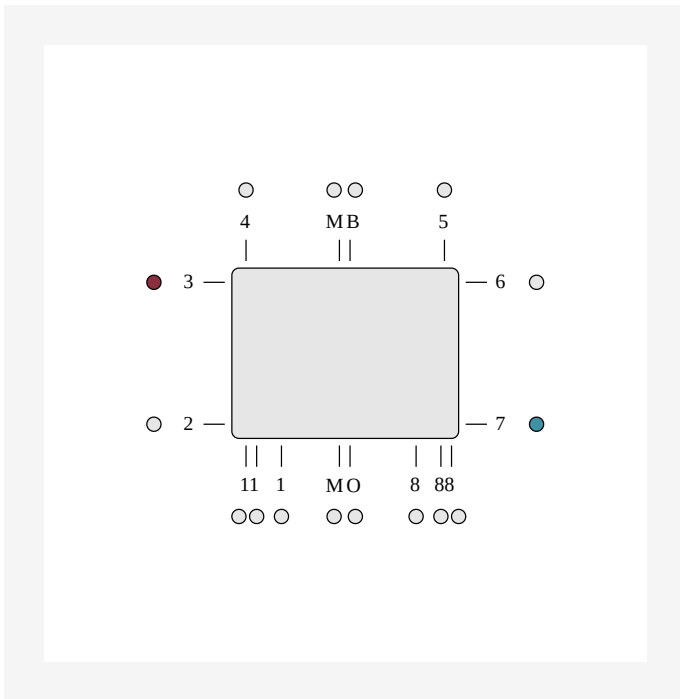

DimensionalDrawing - Diagonaalne ühendus ETIM 37. Diagonaalne ühendus eeldab välise ventiili kasutamist. Diagonaalse ühenduse korral on alumised ühendused suletud.

DimensionalDrawing - Külgühendus ETIM 67. Külgühendus eeldab välise radiaatoriühenduse või ventiili kasutamist. Külgühenduse korral on alumised ühendused suletud.

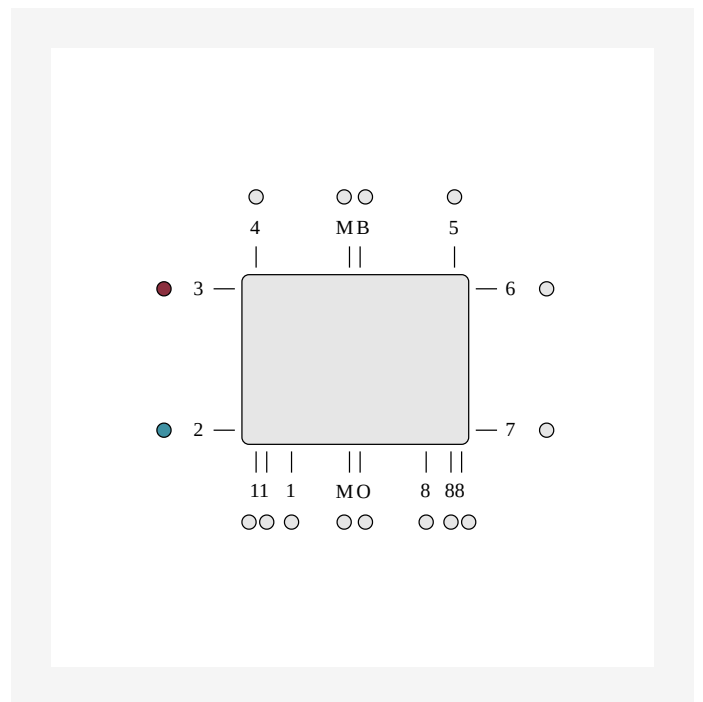
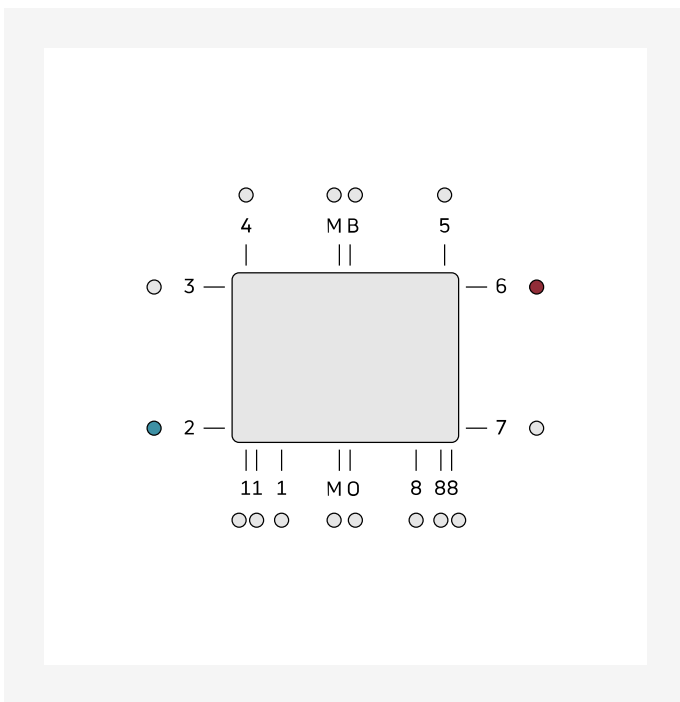

DimensionalDrawing - Diagonaalne ühendus ETIM 62. Diagonaalne ühendus eeldab välise ventiili kasutamist. Diagonaalse ühenduse korral on alumised ühendused suletud.

DimensionalDrawing - Külgühendus ETIM 32. Külgühendus eeldab välise radiaatoriventili kasutamist. Külgühenduse korral on alumised ühendused suletud.



Seotud tooted



Andur

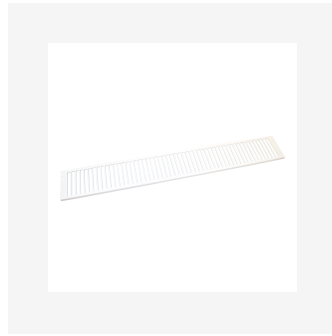

Top Grill ©



Air



Õhutus- ja pimekorgi komplekt



Aerosool parandusvärv



Küljepaneel ©



Monclac seinakronstein



Õhutusvõti



Evosense



RV reguleerimisventiil





300

KÕRGUS 300 mm	PIKKUS	SÜGAVUS	Võimsus (W) 45/35/20°C	Võimsus (W) 55/45/20°C	Võimsus (W) 60/45/20°C	MAHT (l)	N- ekponent	KAAL (kg)
Tüüp 11								
500	60	F061103005010300	81	141	152	0.8	1.30	5.1
600	60	F061103006010300	97	169	183	1.0	1.30	5.9
700	60	F061103007010300	113	197	213	1.2	1.30	6.7
800	60	F061103008010300	129	225	244	1.4	1.30	7.5
900	60	F061103009010300	146	253	274	1.5	1.30	8.3
1000	60	F061103010010300	162	281	305	1.7	1.30	9.2
1100	60	F061103011010300	178	309	335	1.9	1.30	10.0
1200	60	F061103012010300	194	338	366	2.0	1.30	1.6
1600	60	F061103016010300	259	450	488	2.7	1.30	13.8
1800	60	F061103018010300	291	506	549	3.1	1.30	15.4
2000	60	F061103020010300	323	563	610	3.4	1.30	17.0
2300	60	F061103023010300	372	647	701	3.9	1.30	19.4
2600	60	F061103026010300	420	731	792	4.4	1.30	21.7
3000	60	F061103030010300	485	844	914	5.1	1.30	24.9
Tüüp 21								
400	70	F062103004010300	92	158	171	1.4	1.28	6.2
500	70	F062103005010300	115	198	214	1.7	1.28	7.4
600	70	F062103006010300	137	237	257	2.0	1.28	8.6
700	70	F062103007010300	160	277	300	2.4	1.28	10.0
800	70	F062103008010300	183	317	343	2.7	1.28	11.3
900	70	F062103009010300	206	356	385	3.1	1.28	12.3
1000	70	F062103010010300	229	396	428	3.4	1.28	13.6
1100	70	F062103011010300	252	435	471	3.7	1.28	14.8
1400	70	F062103014010300	321	554	600	4.8	1.28	18.7



300

KÕRGUS 300 mm	PIKKUS	SÜGAVUS	Võimsus (W) 45/35/20°C	Võimsus (W) 55/45/20°C	Võimsus (W) 60/45/20°C	MAHT (l)	N- ekponent	KAAL (kg)	
	1600	70	F062103016010300	367	633	685	5.4	1.28	21.1
	2000	70	F062103020010300	458	791	856	6.8	1.28	26.1
	2600	70	F062103026010300	596	1029	1113	8.8	1.28	33.7
Tüüp 22									
	500	102	F062203005010300	141	246	267	1.7	1.31	8.5
	700	102	F062203007010300	197	345	374	2.4	1.31	11.4
	1100	102	F062203011010300	310	542	587	3.7	1.31	17.4
	1200	102	F062203012010300	338	591	640	4.1	1.31	18.5
	1600	102	F062203016010300	451	788	854	5.4	1.31	24.2
	1800	102	F062203018010300	507	886	961	6.1	1.31	27.1
	2000	102	F062203020010300	563	985	1067	6.8	1.31	29.9
	2600	102	F062203026010300	732	1280	1388	8.8	1.31	38.5
	3000	102	F062203030010300	845	1477	1601	10.2	1.31	44.9
Tüüp 33									
	400	152	F063303004010300	157	275	299	2.0	1.31	1.3
	600	152	F063303006010300	236	413	448	3.1	1.31	14.5
	900	152	F063303009010300	354	620	672	4.6	1.31	2.9
	1000	152	F063303010010300	393	688	747	5.1	1.31	23.5
	1100	152	F063303011010300	432	757	821	5.6	1.31	25.2
	1800	152	F063303018010300	707	1239	1344	9.2	1.31	4.7
	2000	152	F063303020010300	786	1377	1493	10.2	1.31	44.3
	2300	152	F063303023010300	904	1583	1717	11.7	1.31	5.7
	2600	152	F063303026010300	1022	1790	1941	13.3	1.31	57.9
	3000	152	F063303030010300	1179	2065	2240	15.3	1.31	65.6



400

KÕRGUS 400 mm	PIKKUS SÜGAVUS		Võimsus (W) 45/35/20°C	Võimsus (W) 55/45/20°C	Võimsus (W) 60/45/20°C	MAHT (l)	N- ekponent	KAAL (kg)
Tüüp 11								
400	60	F061104004010300	84	146	158	0.9	1.30	5.5
600	60	F061104006010300	126	219	238	1.3	1.30	7.6
700	60	F061104007010300	147	256	277	1.5	1.30	8.7
800	60	F061104008010300	168	292	317	1.8	1.30	9.7
1200	60	F061104012010300	252	439	475	2.6	1.30	14.0
2000	60	F061104020010300	419	731	792	4.4	1.30	22.5
2300	60	F061104023010300	482	841	911	5.1	1.30	25.7
3000	60	F061104030010300	629	1097	1188	6.6	1.30	33.2
Tüüp 21								
400	70	F062104004010300	115	199	215	1.8	1.29	7.7
500	70	F062104005010300	143	249	269	2.3	1.29	9.4
800	70	F062104008010300	229	398	431	3.6	1.29	14.5
900	70	F062104009010300	258	448	485	4.0	1.29	16.2
1000	70	F062104010010300	286	497	539	4.5	1.29	17.9
1100	70	F062104011010300	315	547	592	5.0	1.29	19.6
1200	70	F062104012010300	344	597	646	5.4	1.29	21.3
1600	70	F062104016010300	458	796	862	7.2	1.29	28.3
1800	70	F062104018010300	515	895	969	8.1	1.29	31.4
2000	70	F062104020010300	573	994	1077	9.0	1.29	34.8
2300	70	F062104023010300	658	1144	1239	10.3	1.29	39.9
3000	70	F062104030010300	859	1492	1616	13.5	1.29	51.7
Tüüp 22								
400	102	F062204004010300	142	249	270	1.8	1.32	9.2
700	102	F062204007010300	248	436	473	3.1	1.32	15.0
1100	102	F062204011010300	390	685	743	5.0	1.32	22.6



400

KÕRGUS 400 mm	PIKKUS	SÜGAVUS	Võimsus (W) 45/35/20°C	Võimsus (W) 55/45/20°C	Võimsus (W) 60/45/20°C	MAHT (l)	N- ekponent	KAAL (kg)	
	1200	102	F062204012010300	426	747	811	5.4	1.32	24.6
	1400	102	F062204014010300	497	872	946	6.3	1.32	28.4
	1600	102	F062204016010300	568	996	1081	7.2	1.32	32.3
	1800	102	F062204018010300	639	1121	1216	8.1	1.32	36.1
	2000	102	F062204020010300	710	1245	1351	9.0	1.32	40.0
	2300	102	F062204023010300	816	1432	1554	10.3	1.32	45.7
	3000	102	F062204030010300	1064	1868	2026	13.5	1.32	59.2
Tüüp 33									
	400	152	F063304004010300	196	345	375	2.7	1.33	13.5
	500	152	F063304005010300	245	432	468	3.4	1.33	16.4
	700	152	F063304007010300	343	604	656	4.7	1.33	22.1
	800	152	F063304008010300	392	691	749	5.4	1.33	25.0
	900	152	F063304009010300	441	777	843	6.0	1.33	27.9
	1000	152	F063304010010300	490	863	937	6.7	1.33	3.8
	1100	152	F063304011010300	539	950	1031	7.4	1.33	33.6
	1200	152	F063304012010300	588	1036	1124	8.0	1.33	36.5
	1400	152	F063304014010300	686	1209	1312	9.4	1.33	42.3
	1600	152	F063304016010300	785	1381	1499	10.7	1.33	48.5
	1800	152	F063304018010300	883	1554	1686	12.1	1.33	53.9
	2300	152	F063304023010300	1128	1985	2155	15.4	1.33	68.2
	2600	152	F063304026010300	1275	2244	2436	17.4	1.33	76.9
	3000	152	F063304030010300	1471	2590	2811	20.1	1.33	88.4



450

KÕRGUS 450 mm	PIKKUS	SÜGAVUS	Võimsus (W) 45/35/20°C	Võimsus (W) 55/45/20°C	Võimsus (W) 60/45/20°C	MAHT (l)	N- ekponent	KAAL (kg)	
Tüüp 11									
	500	60	F061104505010300	116	203	220	1.3	1.30	7.6
	700	60	F061104507010300	163	284	308	1.8	1.30	1.2
	900	60	F061104509010300	209	365	396	2.3	1.30	12.7
	1100	60	F061104511010300	256	446	484	2.8	1.30	15.2
	1200	60	F061104512010300	279	487	528	3.0	1.30	16.5
	1400	60	F061104514010300	325	568	616	3.5	1.30	19.4
	1800	60	F061104518010300	418	730	791	4.5	1.30	24.5
	2000	60	F061104520010300	465	811	879	5.0	1.30	26.6
	2600	60	F061104526010300	604	1055	1143	6.5	1.30	34.2
	3000	60	F061104530010300	697	1217	1319	7.5	1.30	39.2
Tüüp 21									
	400	70	F062104504010300	125	218	236	2.0	1.30	9.3
	500	70	F062104505010300	157	273	296	2.5	1.30	11.3
	700	70	F062104507010300	219	382	414	3.5	1.30	15.4
	900	70	F062104509010300	282	491	532	4.5	1.30	19.4
	1100	70	F062104511010300	344	600	650	5.5	1.30	23.5
	1200	70	F062104512010300	376	654	709	6.0	1.30	25.5
	1600	70	F062104516010300	501	873	946	8.0	1.30	33.6
	1800	70	F062104518010300	564	982	1064	9.0	1.30	37.7
	2000	70	F062104520010300	626	1091	1182	10.0	1.30	41.6
	2300	70	F062104523010300	720	1254	1359	11.5	1.30	47.7
	2600	70	F062104526010300	814	1418	1537	13.0	1.30	53.8
	3000	70	F062104530010300	939	1636	1773	15.0	1.30	61.9
Tüüp 22									
	400	102	F062204504010300	156	274	297	2.0	1.32	1.6



450

KÕRGUS 450 mm	PIKKUS	SÜGAVUS	Võimsus (W) 45/35/20°C	Võimsus (W) 55/45/20°C	Võimsus (W) 60/45/20°C	MAHT (l)	N- ekponent	KAAL (kg)	
	500	102	F062204505010300	195	343	372	2.5	1.32	13.0
	600	102	F062204506010300	234	411	446	3.0	1.32	15.3
	700	102	F062204507010300	273	480	521	3.5	1.32	17.6
	800	102	F062204508010300	312	548	595	4.0	1.32	19.9
	900	102	F062204509010300	351	617	669	4.5	1.32	22.2
	1000	102	F062204510010300	390	685	744	5.0	1.32	24.5
	1200	102	F062204512010300	468	822	892	6.0	1.32	29.1
	1400	102	F062204514010300	546	960	1041	7.0	1.32	33.7
	1800	102	F062204518010300	702	1234	1339	9.0	1.32	43.0
	2000	102	F062204520010300	780	1371	1487	10.0	1.32	47.6
	2300	102	F062204523010300	897	1576	1711	11.5	1.32	54.5
	3000	102	F062204530010300	1169	2056	2231	15.0	1.32	7.6
Tüüp 33									
	400	152	F063304504010300	215	379	411	3.0	1.33	15.8
	500	152	F063304505010300	268	473	514	3.8	1.33	19.2
	900	152	F063304509010300	483	852	925	6.8	1.33	33.7
	1000	152	F063304510010300	536	947	1028	7.5	1.33	36.5
	1200	152	F063304512010300	644	1136	1233	9.0	1.33	43.3
	1400	152	F063304514010300	751	1326	1439	10.5	1.33	5.2
	1600	152	F063304516010300	858	1515	1645	12.0	1.33	57.1
	2300	152	F063304523010300	1234	2178	2364	17.3	1.33	81.2
	3000	152	F063304530010300	1609	2840	3084	22.5	1.33	107.4



500

KÕRGUS 500 mm	PIKKUS	SÜGAVUS	Võimsus (W) 45/35/20°C	Võimsus (W) 55/45/20°C	Võimsus (W) 60/45/20°C	MAHT (l)	N- ekponent	KAAL (kg)	
Tüüp 11									
	400	60	F061105004010300	102	178	193	1.1	1.31	6.5
	600	60	F061105006010300	153	267	290	1.6	1.31	9.2
	700	60	F061105007010300	178	312	338	1.9	1.31	1.6
	800	60	F061105008010300	204	356	386	2.2	1.31	12.0
	900	60	F061105009010300	229	401	434	2.4	1.31	13.3
	1000	60	F061105010010300	255	445	483	2.7	1.31	14.8
	1100	60	F061105011010300	280	490	531	3.0	1.31	16.4
	1200	60	F061105012010300	306	534	579	3.2	1.31	17.5
	1400	60	F061105014010300	357	623	676	3.8	1.31	2.2
	1600	60	F061105016010300	408	712	772	4.3	1.31	22.9
	1800	60	F061105018010300	459	801	869	4.9	1.31	25.7
	2300	60	F061105023010300	586	1024	1110	6.2	1.31	32.6
	2600	60	F061105026010300	663	1158	1255	7.0	1.31	36.7
Tüüp 21									
	400	70	F062105004010300	136	237	257	2.2	1.31	9.6
	500	70	F062105005010300	170	296	321	2.8	1.31	11.7
	600	70	F062105006010300	204	356	386	3.3	1.31	13.8
	700	70	F062105007010300	237	415	450	3.9	1.31	15.9
	800	70	F062105008010300	271	474	514	4.4	1.31	18.1
	1100	70	F062105011010300	373	652	707	6.0	1.31	24.3
	1200	70	F062105012010300	407	711	771	6.6	1.31	26.4
	1400	70	F062105014010300	475	830	900	7.7	1.31	3.5
	1800	70	F062105018010300	611	1067	1157	9.9	1.31	38.9
	2600	70	F062105026010300	882	1541	1671	14.3	1.31	55.6
	3000	70	F062105030010300	1018	1778	1928	16.5	1.31	64.0



500

KÕRGUS 500 mm	PIKKUS	SÜGAVUS	Võimsus (W) 45/35/20°C	Võimsus (W) 55/45/20°C	Võimsus (W) 60/45/20°C	MAHT (l)	N- ekponent	KAAL (kg)
Tüüp 22								
400	102	F062205004010300	169	299	324	2.2	1.33	11.2
500	102	F062205005010300	212	373	405	2.8	1.33	13.7
600	102	F062205006010300	254	448	486	3.3	1.33	16.4
800	102	F062205008010300	339	597	648	4.4	1.33	2.9
900	102	F062205009010300	381	672	729	5.0	1.33	23.4
1600	102	F062205016010300	678	1194	1296	8.8	1.33	4.3
2000	102	F062205020010300	847	1493	1620	11.0	1.33	5.1
2300	102	F062205023010300	974	1717	1863	12.7	1.33	57.3
2600	102	F062205026010300	1102	1940	2106	14.3	1.33	64.6
3000	102	F062205030010300	1271	2239	2430	16.5	1.33	74.3
Tüüp 33								
400	152	F063305004010300	232	411	447	3.3	1.34	16.6
500	152	F063305005010300	290	514	558	4.1	1.34	2.2
600	152	F063305006010300	349	617	670	4.9	1.34	23.9
700	152	F063305007010300	407	719	781	5.7	1.34	27.6
800	152	F063305008010300	465	822	893	6.6	1.34	31.1
900	152	F063305009010300	523	925	1005	7.4	1.34	34.8
1000	152	F063305010010300	581	1028	1116	8.2	1.34	38.5
1100	152	F063305011010300	639	1131	1228	9.0	1.34	42.4
1200	152	F063305012010300	697	1233	1340	9.8	1.34	45.7
1400	152	F063305014010300	813	1439	1563	11.5	1.34	52.9
1600	152	F063305016010300	930	1645	1786	13.1	1.34	6.2
1800	152	F063305018010300	1046	1850	2009	14.8	1.34	67.5
2000	152	F063305020010300	1162	2056	2233	16.4	1.34	74.7
2300	152	F063305023010300	1336	2364	2567	18.9	1.34	85.6



550

KÕRGUS 550 mm	PIKKUS	SÜGAVUS	Võimsus (W) 45/35/20°C	Võimsus (W) 55/45/20°C	Võimsus (W) 60/45/20°C	MAHT (l)	N- ekponent	KAAL (kg)	
Tüüp 11									
	500	60	F061105505010300	138	242	262	1.5	1.31	8.8
	600	60	F061105506010300	166	290	315	1.8	1.31	1.2
	700	60	F061105507010300	194	339	367	2.1	1.31	11.8
	800	60	F061105508010300	221	387	419	2.4	1.31	13.2
	900	60	F061105509010300	249	435	472	2.7	1.31	14.7
	1000	60	F061105510010300	277	484	524	3.0	1.31	16.1
	1100	60	F061105511010300	304	532	577	3.3	1.31	17.6
	1200	60	F061105512010300	332	580	629	3.6	1.31	19.1
	1600	60	F061105516010300	443	774	839	4.8	1.31	25.5
	1800	60	F061105518010300	498	871	944	5.4	1.31	28.0
	2000	60	F061105520010300	553	967	1049	6.0	1.31	3.9
	2300	60	F061105523010300	636	1112	1206	6.9	1.31	35.3
	2600	60	F061105526010300	719	1257	1363	7.8	1.31	39.8
Tüüp 21									
	500	70	F062105505010300	182	319	346	3.0	1.31	12.8
	600	70	F062105506010300	219	383	415	3.7	1.31	15.3
	700	70	F062105507010300	255	447	484	4.3	1.31	17.7
	800	70	F062105508010300	291	511	554	4.9	1.31	2.2
	1000	70	F062105510010300	364	638	692	6.1	1.31	25.6
	1100	70	F062105511010300	401	702	761	6.7	1.31	27.5
	1400	70	F062105514010300	510	893	969	8.5	1.31	34.9
	1600	70	F062105516010300	583	1021	1107	9.8	1.31	39.8
	2000	70	F062105520010300	728	1276	1384	12.2	1.31	49.6
	2300	70	F062105523010300	838	1468	1592	14.0	1.31	56.9
	2600	70	F062105526010300	947	1659	1799	15.9	1.31	64.3



550

KÕRGUS 550 mm	PIKKUS	SÜGAVUS	Võimsus (W) 45/35/20°C	Võimsus (W) 55/45/20°C	Võimsus (W) 60/45/20°C	MAHT (l)	N- ekponent	KAAL (kg)	
	3000	70	F062105530010300	1093	1915	2076	18.3	1.31	74.9
Tüüp 22	400	102	F062205504010300	183	322	350	2.4	1.33	12.2
	500	102	F062205505010300	228	403	437	3.0	1.33	14.9
	800	102	F062205508010300	365	645	700	4.9	1.33	23.2
	1000	102	F062205510010300	457	806	875	6.1	1.33	28.7
	1200	102	F062205512010300	548	967	1050	7.3	1.33	34.3
	1600	102	F062205516010300	731	1289	1400	9.8	1.33	45.3
	1800	102	F062205518010300	822	1451	1575	11.0	1.33	5.8
	2000	102	F062205520010300	913	1612	1750	12.2	1.33	56.3
	2300	102	F062205523010300	1050	1854	2012	14.0	1.33	64.6
	2600	102	F062205526010300	1187	2095	2275	15.9	1.33	72.9
	3000	102	F062205530010300	1370	2418	2625	18.3	1.33	83.9
Tüüp 33	600	152	F063305506010300	374	664	721	5.4	1.34	26.6
	900	152	F063305509010300	561	996	1082	8.1	1.34	38.3
	1100	152	F063305511010300	686	1217	1322	9.9	1.34	46.4
	1200	152	F063305512010300	749	1328	1442	10.8	1.34	5.5
	1400	152	F063305514010300	873	1549	1683	12.6	1.34	58.6
	1800	152	F063305518010300	1123	1992	2164	16.2	1.34	74.8
	2300	152	F063305523010300	1435	2545	2765	20.7	1.34	95.2
	2600	152	F063305526010300	1622	2877	3125	23.4	1.34	109.4
	3000	152	F063305530010300	1872	3319	3606	27.0	1.34	123.6



600

KÕRGUS 600 mm	PIKKUS	SÜGAVUS	Võimsus (W) 45/35/20°C	Võimsus (W) 55/45/20°C	Võimsus (W) 60/45/20°C	MAHT (l)	N- ekponent	KAAL (kg)	
Tüüp 11									
	500	60	F061106005010300	149	260	282	1.6	1.31	9.5
	600	60	F061106006010300	179	313	339	1.9	1.31	11.1
	700	60	F061106007010300	208	365	395	2.2	1.31	12.7
	900	60	F061106009010300	268	469	508	2.9	1.31	16.0
	1000	60	F061106010010300	298	521	565	3.2	1.31	17.6
	1100	60	F061106011010300	327	573	621	3.5	1.31	19.2
	1400	60	F061106014010300	417	729	791	4.5	1.31	24.4
	1600	60	F061106016010300	476	834	904	5.1	1.31	27.3
	1800	60	F061106018010300	536	938	1017	5.8	1.31	3.5
	2000	60	F061106020010300	595	1042	1130	6.4	1.31	33.7
	2300	60	F061106023010300	685	1198	1299	7.4	1.31	38.6
	2600	60	F061106026010300	774	1354	1469	8.3	1.31	43.4
	3000	60	F061106030010300	893	1563	1695	9.6	1.31	49.8
Tüüp 21									
	400	70	F062106004010300	155	273	296	2.6	1.32	11.5
	500	70	F062106005010300	194	341	370	3.3	1.32	14.4
	800	70	F062106008010300	311	546	592	5.3	1.32	21.7
	900	70	F062106009010300	349	614	666	5.9	1.32	24.3
	1000	70	F062106010010300	388	682	740	6.6	1.32	26.8
	1100	70	F062106011010300	427	751	814	7.3	1.32	29.4
	1200	70	F062106012010300	466	819	888	7.9	1.32	31.9
	1400	70	F062106014010300	544	955	1036	9.2	1.32	37.3
	1600	70	F062106016010300	621	1092	1184	10.6	1.32	42.1
	1800	70	F062106018010300	699	1228	1332	11.9	1.32	47.2
	2000	70	F062106020010300	777	1365	1481	13.2	1.32	52.3



600

KÕRGUS 600 mm	PIKKUS	SÜGAVUS	Võimsus (W) 45/35/20°C	Võimsus (W) 55/45/20°C	Võimsus (W) 60/45/20°C	MAHT (l)	N- ekponent	KAAL (kg)	
Tüüp 22									
	400	102	F062206004010300	195	346	375	2.6	1.34	13.8
	500	102	F062206005010300	244	432	469	3.3	1.34	16.8
	600	102	F062206006010300	293	518	563	4.0	1.34	19.6
	700	102	F062206007010300	342	605	657	4.6	1.34	22.6
	800	102	F062206008010300	391	691	750	5.3	1.34	25.5
	1000	102	F062206010010300	488	864	938	6.6	1.34	31.4
	1100	102	F062206011010300	537	950	1032	7.3	1.34	34.3
	1200	102	F062206012010300	586	1037	1126	7.9	1.34	37.2
	1800	102	F062206018010300	879	1555	1688	11.9	1.34	54.9
	2000	102	F062206020010300	977	1728	1876	13.2	1.34	6.7
	2300	102	F062206023010300	1124	1987	2157	15.2	1.34	69.5
	3000	102	F062206030010300	1465	2591	2814	19.8	1.34	90.0
Tüüp 33									
	500	152	F063306005010300	333	592	643	4.9	1.35	24.5
	600	152	F063306006010300	399	710	771	5.9	1.35	28.9
	800	152	F063306008010300	532	946	1029	7.8	1.35	37.6
	900	152	F063306009010300	599	1065	1157	8.8	1.35	42.2
	1000	152	F063306010010300	665	1183	1286	9.8	1.35	46.4
	1100	152	F063306011010300	732	1301	1414	10.8	1.35	5.9
	1200	152	F063306012010300	798	1420	1543	11.8	1.35	55.2
	1600	152	F063306016010300	1065	1893	2057	15.7	1.35	72.8
	1800	152	F063306018010300	1198	2129	2314	17.6	1.35	81.5
	2000	152	F063306020010300	1331	2366	2571	19.6	1.35	9.4
	2300	152	F063306023010300	1530	2721	2957	22.5	1.35	105.5
	2600	152	F063306026010300	1730	3076	3343	25.5	1.35	116.7



900

KÕRGUS 900 mm	PIKKUS	SÜGAVUS	Võimsus (W) 45/35/20°C	Võimsus (W) 55/45/20°C	Võimsus (W) 60/45/20°C	MAHT (l)	N- ekponent	KAAL (kg)	
Tüüp 11									
	800	60	F061109008010300	332	583	632	3.6	1.32	21.7
	900	60	F061109009010300	374	655	711	4.0	1.32	24.2
	1200	60	F061109012010300	498	874	948	5.4	1.32	31.6
	1600	60	F061109016010300	664	1165	1264	7.2	1.32	41.6
	2000	60	F061109020010300	830	1456	1580	9.0	1.32	51.5
	2300	60	F061109023010300	955	1675	1817	10.3	1.32	58.9
	2600	60	F061109026010300	1079	1893	2054	11.7	1.32	66.4
Tüüp 21									
	400	70	F062109004010300	212	376	408	3.6	1.34	16.7
	500	70	F062109005010300	265	470	510	4.5	1.34	2.6
	700	70	F062109007010300	371	657	714	6.3	1.34	28.6
	800	70	F062109008010300	424	751	816	7.2	1.34	31.8
	900	70	F062109009010300	477	845	918	8.1	1.34	35.6
	1000	70	F062109010010300	530	939	1020	9.0	1.34	39.5
	1100	70	F062109011010300	583	1033	1122	9.9	1.34	43.2
	1200	70	F062109012010300	636	1127	1224	10.8	1.34	47.0
	1600	70	F062109016010300	849	1502	1632	14.4	1.34	62.8
	2000	70	F062109020010300	1061	1878	2040	18.0	1.34	77.2
	2300	70	F062109023010300	1220	2160	2346	20.7	1.34	88.5
	2600	70	F062109026010300	1379	2442	2652	23.4	1.34	101.8
	3000	70	F062109030010300	1591	2817	3060	27.0	1.34	115.0
Tüüp 22									
	400	102	F062209004010300	268	478	520	3.6	1.36	19.8
	500	102	F062209005010300	335	597	649	4.5	1.36	24.2
	600	102	F062209006010300	402	717	779	5.4	1.36	28.7



900

KÕRGUS 900 mm	PIKKUS	SÜGAVUS	Võimsus (W) 45/35/20°C	Võimsus (W) 55/45/20°C	Võimsus (W) 60/45/20°C	MAHT (l)	N- ekponent	KAAL (kg)	
	700	102	F062209007010300	469	836	909	6.3	1.36	33.2
	800	102	F062209008010300	536	956	1039	7.2	1.36	37.7
	900	102	F062209009010300	603	1075	1169	8.1	1.36	42.2
	1000	102	F062209010010300	670	1194	1299	9.0	1.36	46.7
	1100	102	F062209011010300	737	1314	1429	9.9	1.36	51.2
	1200	102	F062209012010300	804	1433	1559	10.8	1.36	55.7
	1400	102	F062209014010300	938	1672	1818	12.6	1.36	64.7
	1600	102	F062209016010300	1072	1911	2078	14.4	1.36	73.7
	2000	102	F062209020010300	1339	2389	2598	18.0	1.36	91.6
	2300	102	F062209023010300	1540	2747	2987	20.7	1.36	107.2
	2600	102	F062209026010300	1741	3106	3377	23.4	1.36	118.7
	3000	102	F062209030010300	2009	3583	3896	27.0	1.36	136.6
Tüüp 33									
	500	152	F063309005010300	455	814	885	6.7	1.36	35.4
	600	152	F063309006010300	547	976	1062	8.0	1.36	42.9
	700	152	F063309007010300	638	1139	1239	9.3	1.36	48.8
	900	152	F063309009010300	820	1465	1593	12.0	1.36	62.3
	1100	152	F063309011010300	1002	1790	1947	14.6	1.36	75.6
	1400	152	F063309014010300	1275	2278	2478	19.0	1.36	96.0
	1600	152	F063309016010300	1457	2604	2832	21.3	1.36	111.3
	1800	152	F063309018010300	1640	2929	3186	23.9	1.36	122.6
	2300	152	F063309023010300	2095	3743	4071	30.6	1.36	156.8