



Duomenų lapas
2026-06-15

Plan Hygiene (FH)

Plokštelinis radiatorius su lygiu priekiniu skydu, atitinkantis higienos reikalavimus.



- ✓ Lengvai valomas
- ✓ Aukšti higienos reikalavimai
- ✓ Tvirta konstrukcija
- ✓ Efektyvus šildymas
- ✓ Estetiškas dizainas

Plan Hygiene plokščiasis radiatorius su visiškai lygiu priekiniu paviršiumi, vienodai priklijuotu prie šilumokaičio, be matomų kraštų, skirtas sveikatos priežiūros ir švarioms patalpoms; be konvekcinių elementų ir grotelių, komplekte kamštis ir nuorinimo vožtuvas, RAL 9016.



Pritaikymo sritis

Plan Hygiene tinka higienos patalpoms — ligoninėms, klinikoms. Atvira ir lygi konstrukcija, lengva valyti, neleidžia kauptis dulkiams.

Matmenų parinkimas

Norint užtikrinti teisingą produktų pasirinkimą, prašome naudoti mūsų skaičiavimo įrankius ir produktų bukletus. Jei reikia pagalbos, susisiekite su mūsų pardavimo komanda.

Naudojimas

Plan Hygiene radiatorių montuok pagal standartines hidraulines praktikas, užtikrindamas, kad gaminio etiketė

būtų nukreipta į sieną; kasdienė priežiūra apima paviršiaus valymą patvirtintomis valymo priemonėmis ir atsargų elgesį, kad nepažeistum lygios dangos; įsitikink, kad radiatorius veikia nustatytoje slėgio ir temperatūros ribose ir atlik reguliarias patikras.

AMA tekstas

Plan Hygiene plokštelinis radiatorius su visiškai lygiu priekiniu paviršiumi, priklijuotu prie profilio be matomų kraštų. Be konvektorių, šoninių panelių ir viršutinės grotelės – higieniškai reiklioms zonoms. Keturi G 1/2" šoniniai prijungimai montavimui iš bet kurios pusės. Atitinka EN442-1 ir turi CE. Komplekte kamštis ir nuorinimo vožtuvas. Standartas RAL 9016; kiti tonai pagal užsakymą. Garantija 10 metų.



Specifikacijos

SAVYBĖS	VIENETAS	REIŠMĖS
ETIM klasė		ECO11022
Medžiaga		Plienas
Tipas		10, 20, 30
Paviršiaus struktūra		Lygus sklandus
Maks. darbinis slėgis	bar	10
Standartinių jungčių skaičius		4
Šilumos atidavimas pagal pripažintą EN 442 laboratoriją		Taip
Maksimali veikimo temperatūra	°C	110
Standartinė spalva		Taip
Spalva		Baltas
RAL numeris		9016
Grotelės/Dangtelių plokštė		Taip
Grotelės/Dangtelių plokštė		Taip
Blizgesio vertė		Blizgus
Srieginis matmuo (coliai)		1/2 colio
Jungties sriegis		Vidinis sriegis
Su vieno taško jungtimi		Taip
Su oro išleidimo jungtimi		Taip
Su oro išleidimo vožtuvu/nuorintuvu		Taip
Su išleidimo galimybe		Taip



Ištekliai

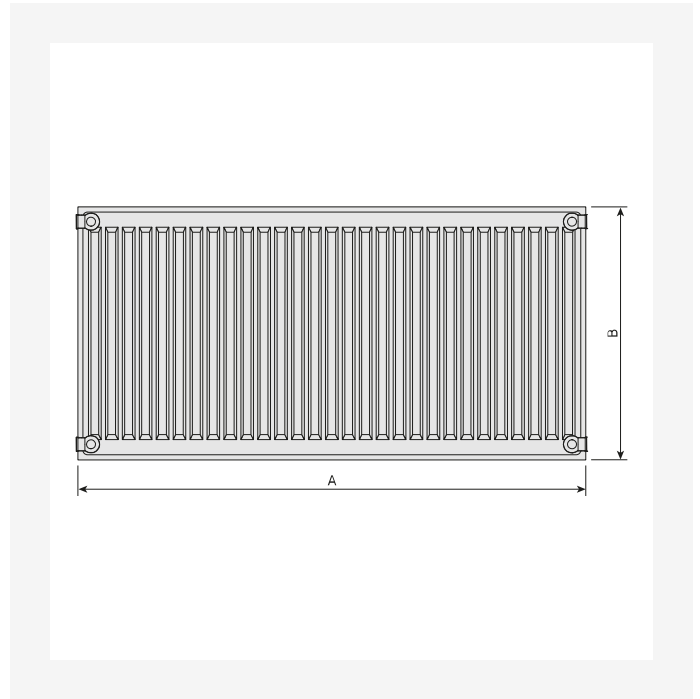

ProductImage - Panel radiator Plan Hygiene, FH.

DimensionalDrawing - Plan Hygiene, vaizdas iš galo

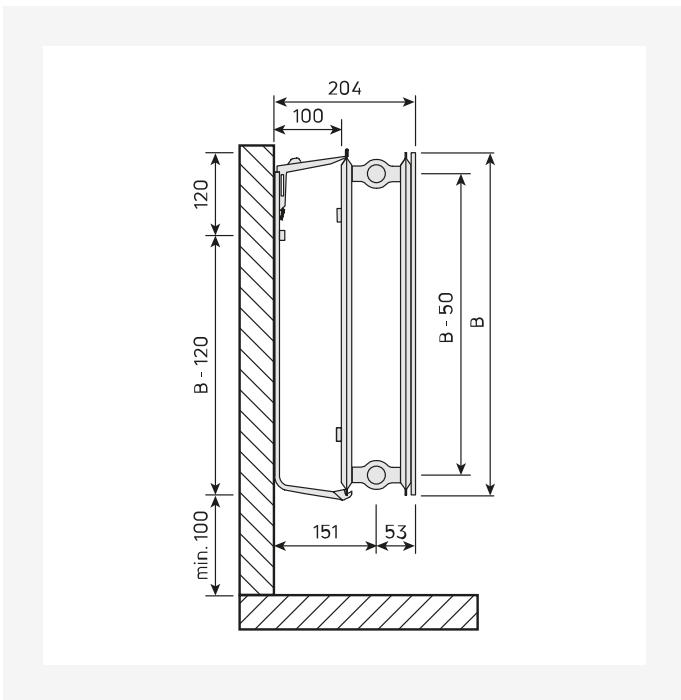

DimensionalDrawing - Plan Hygiene, tipas 20, vaizdas iš šono

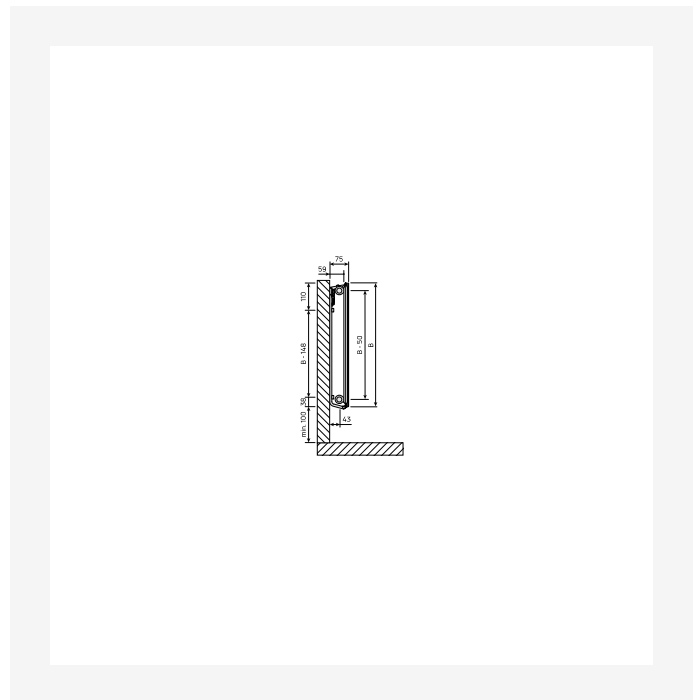

DimensionalDrawing - Plan Hygiene, tipas 10, vaizdas iš šono, MCK



Ištekliai

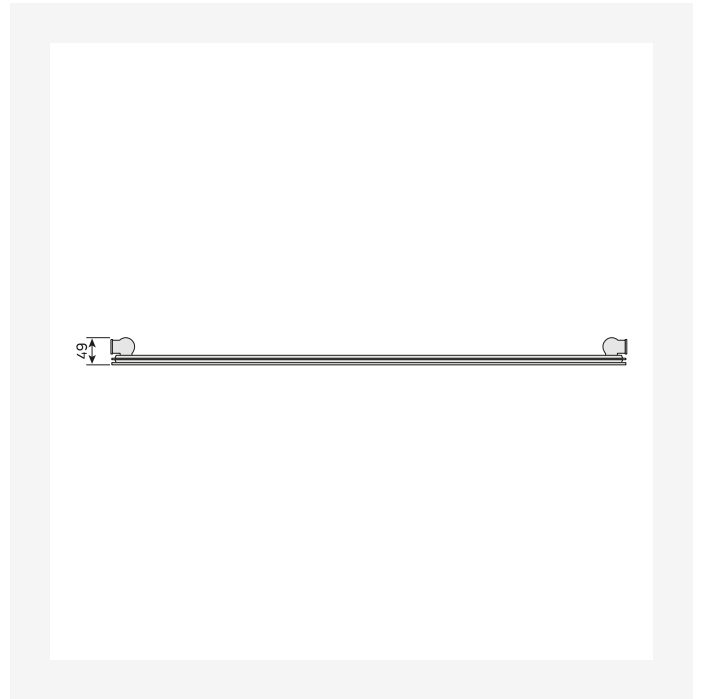

DimensionalDrawing - Plan Hygiene, tipas 30, vaizdas iš viršaus

DimensionalDrawing - Plan Hygiene, tipas 10, vaizdas iš viršaus

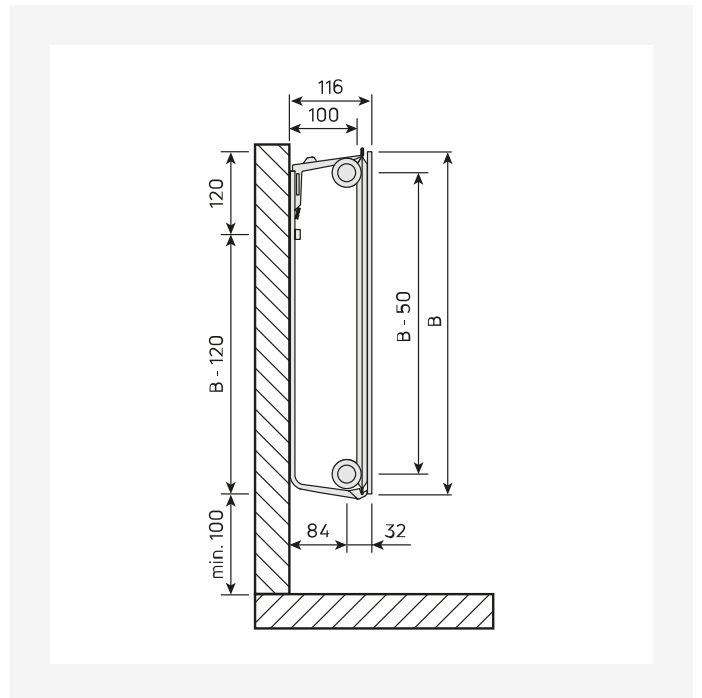
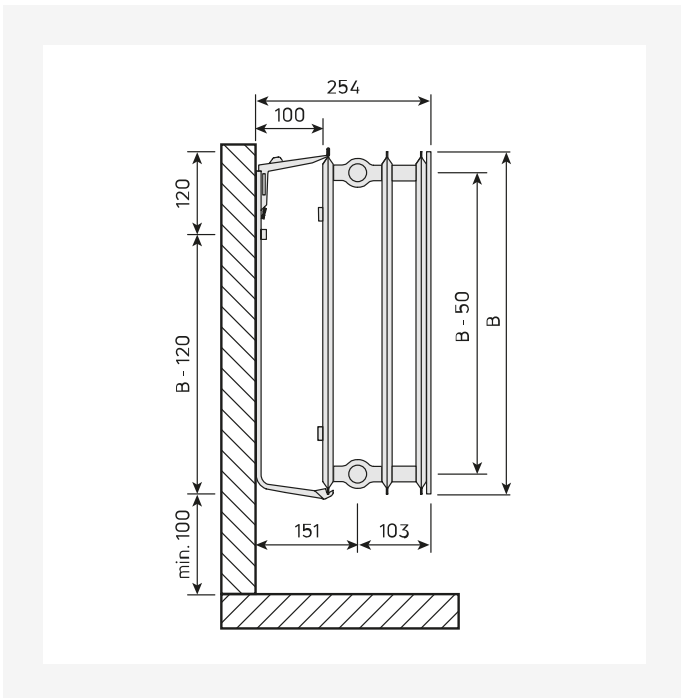

DimensionalDrawing - Plan Hygiene, tipas 30, vaizdas iš šono

DimensionalDrawing - Plan Hygiene, tipas 10, vaizdas iš šono



Ištekliai

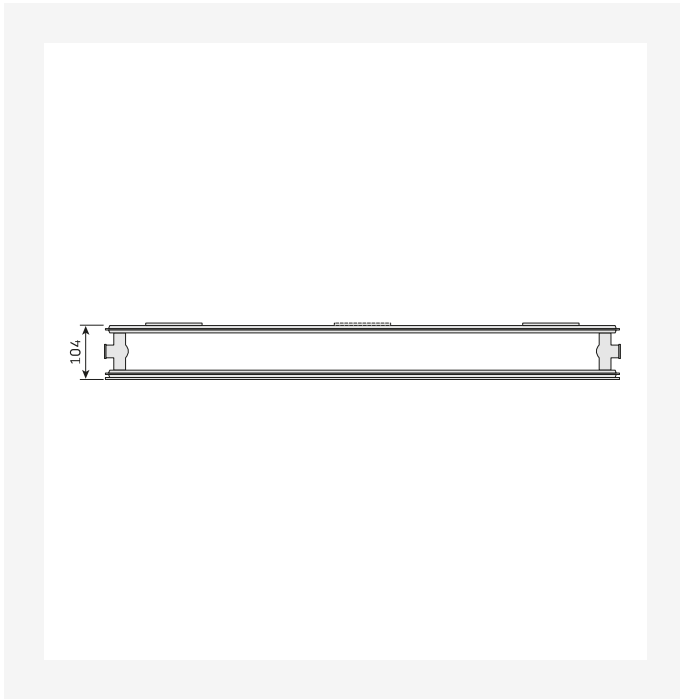

DimensionalDrawing - Plan Hygiene, tipas 20, vaizdas iš viršaus

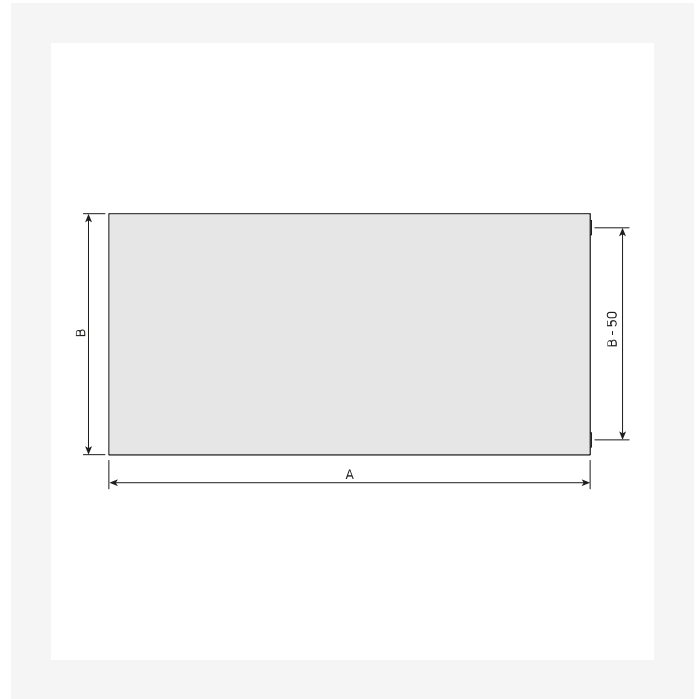

DimensionalDrawing - Plan Hygiene, vaizdas iš priekio

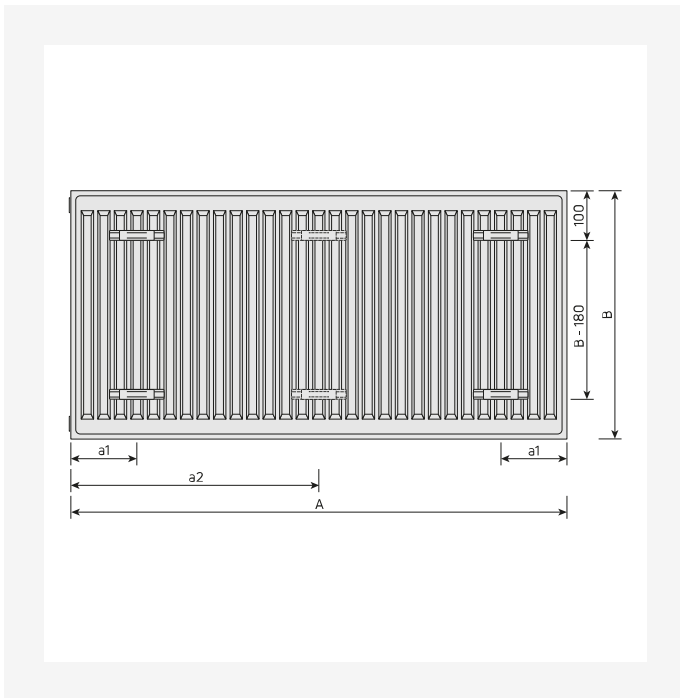

DimensionalDrawing - Plan Hygiene, vaizdas iš galo

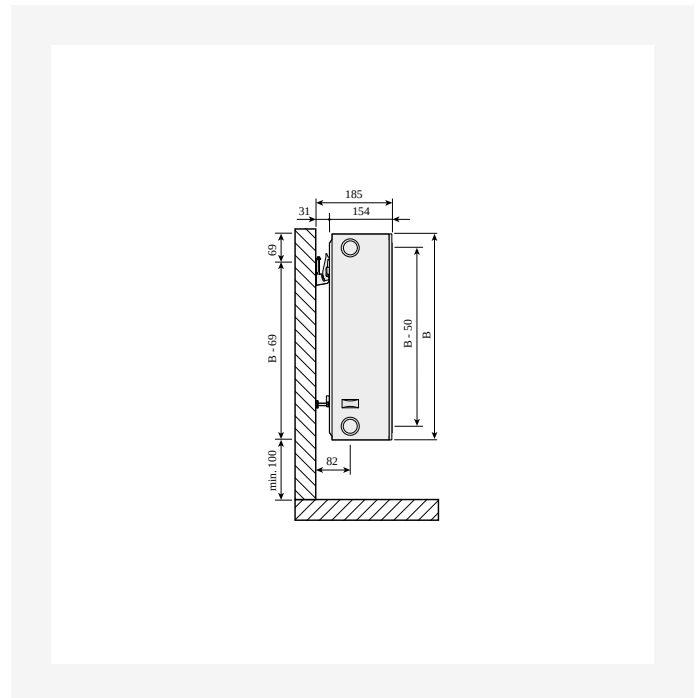

DimensionalDrawing - Plan Compact, Ramo Compact, tipas 33, vaizdas iš šono SSMS



Ištekliai



DimensionalDrawing - Hygiene Plan Compact, tipas 30, vaizdas iš viršaus

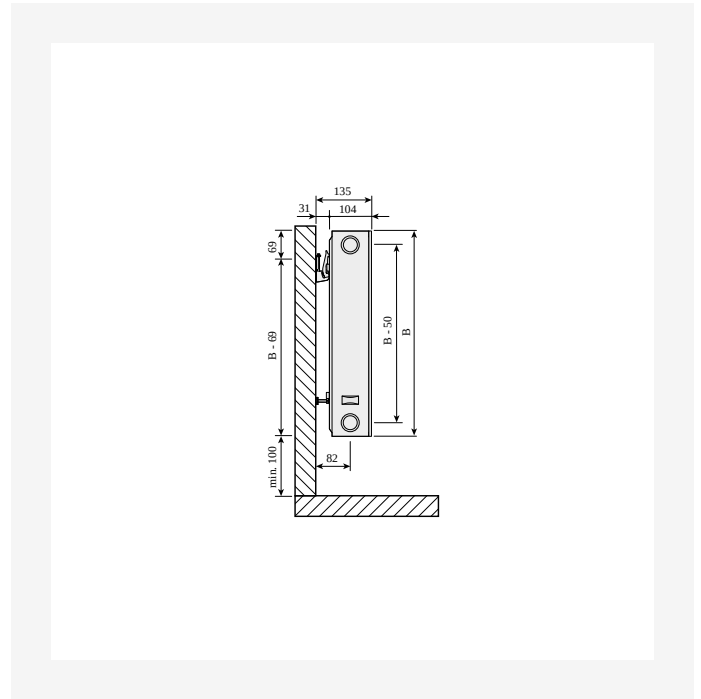

DimensionalDrawing - Plan Compact / Ramo Compact, tipas 22, vaizdas iš šono su SSMS sieniniais laikikliais



DimensionalDrawing - Hygiene Plan Compact, tipas 20, vaizdas iš viršaus



Susiję produktai



Top Grill ©



Remontiniai dažai -
purškiami



Šoninis panelis ©



300

AUKŠTIS 300 mm	ILGIS GYLIS		Galia (W) 45/35/20°C	Galia (W) 55/45/20°C	Galia (W) 60/45/20°C	TÜRIS (l)	N- eksponentas	SVORIS (kg)
Tipas 10								
400	49	F091003004001300	37	64	70	0.7	1.31	4.4
500	49	F091003005001300	46	80	87	0.8	1.31	5.3
600	49	F091003006001300	55	96	105	1.0	1.31	6.2
700	49	F091003007001300	64	112	122	1.2	1.31	7.0
800	49	F091003008001300	73	128	139	1.4	1.31	7.9
900	49	F091003009001300	83	144	157	1.5	1.31	8.7
1000	49	F091003010001300	92	161	174	1.7	1.31	9.6
1100	49	F091003011001300	101	177	191	1.9	1.31	10.4
1200	49	F091003012001300	110	193	209	2.0	1.31	11.2
1400	49	F091003014001300	129	225	244	2.4	1.31	12.9
1600	49	F091003016001300	147	257	279	2.7	1.31	14.6
1800	49	F091003018001300	165	289	313	3.1	1.31	16.3
2000	49	F091003020001300	184	321	348	3.4	1.31	18.0
2300	49	F091003023001300	211	369	400	3.9	1.31	21.0
2600	49	F091003026001300	239	417	453	4.4	1.31	23.6
3000	49	F091003030001300	276	482	522	5.1	1.31	27.1
Tipas 20								
400	104	F092003004000300	73	125	135	1.4	1.27	6.1
500	104	F092003005000300	91	156	169	1.7	1.27	7.5
600	104	F092003006000300	109	187	203	2.0	1.27	8.8
700	104	F092003007000300	127	219	237	2.4	1.27	11
800	104	F092003008000300	145	250	270	2.7	1.27	11.5
900	104	F092003009000300	164	281	304	3.1	1.27	12.8
1000	104	F092003010000300	182	312	338	3.4	1.27	14.1



300

AUKŠTIS 300 mm	ILGIS	GYLIS		Galia (W) 45/35/20°C	Galia (W) 55/45/20°C	Galia (W) 60/45/20°C	TŪRIS (l)	N- ekspontas	SVORIS (kg)
	1100	104	F092003011000300	200	344	372	3.7	1.27	15.5
	1200	104	F092003012000300	218	375	406	4.1	1.27	16.8
	1400	104	F092003014000300	254	437	473	4.8	1.27	19.4
	1600	104	F092003016000300	291	500	541	5.4	1.27	22.5
	1800	104	F092003018000300	327	562	608	6.1	1.27	24.7
	2000	104	F092003020000300	363	625	676	6.8	1.27	27.5
	2300	104	F092003023000300	418	719	777	7.8	1.27	31.4
	2600	104	F092003026000300	472	812	879	8.8	1.27	35.4
	3000	104	F092003030000300	545	937	1014	10.2	1.27	4.8
Tipas 30									
	400	154	F093003004000300	99	172	187	2.0	1.29	7.7
	500	154	F093003005000300	124	215	233	2.5	1.29	9.5
	600	154	F093003006000300	149	259	280	3.1	1.29	11.4
	700	154	F093003007000300	174	302	327	3.6	1.29	13.2
	800	154	F093003008000300	199	345	373	4.1	1.29	15.1
	900	154	F093003009000300	223	388	420	4.6	1.29	16.9
	1000	154	F093003010000300	248	431	467	5.1	1.29	18.9
	1100	154	F093003011000300	273	474	513	5.6	1.29	2.7
	1200	154	F093003012000300	298	517	560	6.1	1.29	22.6
	1400	154	F093003014000300	348	603	653	7.1	1.29	26.2
	1600	154	F093003016000300	397	689	747	8.2	1.29	29.9
	1800	154	F093003018000300	447	776	840	9.2	1.29	33.6
	2000	154	F093003020000300	496	862	933	10.2	1.29	37.3
	2300	154	F093003023000300	571	991	1073	11.7	1.29	42.8
	2600	154	F093003026000300	645	1120	1213	13.3	1.29	48.4
	3000	154	F093003030000300	745	1293	1400	15.3	1.29	55.8



400

AUKŠTIS 400 mm	ILGIS	GYLIS		Galia (W) 45/35/20°C	Galia (W) 55/45/20°C	Galia (W) 60/45/20°C	TŪRIS (l)	N- ekspontas	SVORIS (kg)
Tipas 10									
	400	49	F091004004001300	49	85	92	0.9	1.29	5.5
	500	49	F091004005001300	61	106	115	1.1	1.29	6.7
	600	49	F091004006001300	73	128	138	1.3	1.29	7.8
	700	49	F091004007001300	86	149	161	1.5	1.29	9.0
	800	49	F091004008001300	98	170	185	1.8	1.29	10.1
	900	49	F091004009001300	110	192	208	2.0	1.29	11.2
	1000	49	F091004010001300	123	213	231	2.2	1.29	12.3
	1100	49	F091004011001300	135	234	253	2.4	1.29	13.5
	1200	49	F091004012001300	147	255	276	2.6	1.29	14.6
	1400	49	F091004014001300	172	298	323	3.1	1.29	16.9
	1600	49	F091004016001300	196	341	369	3.5	1.29	19.1
	1800	49	F091004018001300	221	383	415	4.0	1.29	21.4
	2000	49	F091004020001300	245	426	461	4.4	1.29	23.7



500

AUKŠTIS 500 mm	ILGIS	GYLIS		Galia (W) 45/35/20°C	Galia (W) 55/45/20°C	Galia (W) 60/45/20°C	TŪRIS (l)	N- ekspontas	SVORIS (kg)
Tipas 10									
	400	49	F091005004001300	61	105	114	1.1	1.28	6.5
	500	49	F091005005001300	76	131	142	1.4	1.28	8.0
	600	49	F091005006001300	91	158	171	1.6	1.28	9.5
	700	49	F091005007001300	107	184	199	1.9	1.28	10.9
	800	49	F091005008001300	122	210	228	2.2	1.28	12.3
	900	49	F091005009001300	137	236	256	2.4	1.28	13.7
	1000	49	F091005010001300	152	263	284	2.7	1.28	15.1
	1100	49	F091005011001300	168	289	313	3.0	1.28	16.5
	1200	49	F091005012001300	183	315	341	3.2	1.28	17.9
	1400	49	F091005014001300	213	368	398	3.8	1.28	20.6
	1600	49	F091005016001300	244	420	455	4.3	1.28	23.4
	1800	49	F091005018001300	274	473	512	4.9	1.28	26.1
	2000	49	F091005020001300	304	526	569	5.4	1.28	28.9
	2300	49	F091005023001300	350	604	654	6.2	1.28	34.5
	2600	49	F091005026001300	396	683	739	7.0	1.28	38.9
	3000	49	F091005030001300	457	788	853	8.1	1.28	44.8
Tipas 20									
	400	104	F092005004000300	106	183	198	2.2	1.28	9.3
	500	104	F092005005000300	132	229	248	2.8	1.28	11.5
	600	104	F092005006000300	159	274	297	3.3	1.28	13.7
	700	104	F092005007000300	185	320	347	3.9	1.28	15.8
	800	104	F092005008000300	212	366	396	4.4	1.28	18.0
	900	104	F092005009000300	238	412	446	5.0	1.28	2.2
	1000	104	F092005010000300	265	457	495	5.5	1.28	22.3
	1100	104	F092005011000300	291	503	545	6.0	1.28	24.5



500

AUKŠTIS 500 mm	ILGIS	GYLIS		Galia (W) 45/35/20°C	Galia (W) 55/45/20°C	Galia (W) 60/45/20°C	TŪRIS (l)	N- ekspontas	SVORIS (kg)
	1200	104	F092005012000300	318	549	594	6.6	1.28	26.7
	1400	104	F092005014000300	371	640	693	7.7	1.28	31.1
	1600	104	F092005016000300	424	732	792	8.8	1.28	35.3
	1800	104	F092005018000300	477	823	891	9.9	1.28	39.7
	2000	104	F092005020000300	530	915	990	11.0	1.28	44.1
	2300	104	F092005023000300	609	1052	1139	12.7	1.28	5.5
	2600	104	F092005026000300	689	1189	1287	14.3	1.28	57.5
	3000	104	F092005030000300	794	1372	1485	16.5	1.28	65.7
Tipas 30									
	400	154	F093005004000300	144	251	272	3.3	1.30	11.7
	500	154	F093005005000300	180	313	340	4.1	1.30	14.8
	600	154	F093005006000300	216	376	408	4.9	1.30	17.8
	700	154	F093005007000300	252	439	475	5.7	1.30	2.8
	800	154	F093005008000300	288	501	543	6.6	1.30	23.8
	900	154	F093005009000300	324	564	611	7.4	1.30	26.9
	1000	154	F093005010000300	360	627	679	8.2	1.30	30.0
	1100	154	F093005011000300	396	689	747	9.0	1.30	32.9
	1200	154	F093005012000300	431	752	815	9.8	1.30	36.0
	1400	154	F093005014000300	503	877	951	11.5	1.30	42.0
	1600	154	F093005016000300	575	1003	1087	13.1	1.30	48.5
	1800	154	F093005018000300	647	1128	1223	14.8	1.30	54.9
	2000	154	F093005020000300	719	1253	1358	16.4	1.30	6.2
	2300	154	F093005023000300	827	1442	1562	18.9	1.30	69.3
	2600	154	F093005026000300	935	1630	1766	21.3	1.30	78.3
	3000	154	F093005030000300	1079	1880	2038	24.6	1.30	9.4



600

AUKŠTIS 600 mm	ILGIS	GYLIS		Galia (W) 45/35/20°C	Galia (W) 55/45/20°C	Galia (W) 60/45/20°C	TŪRIS (l)	N- ekspontas	SVORIS (kg)
Tipas 10									
	400	49	F091006004001300	72	124	134	1.3	1.26	8.0
	500	49	F091006005001300	90	155	168	1.6	1.26	9.7
	600	49	F091006006001300	108	186	201	1.9	1.26	11.4
	700	49	F091006007001300	126	217	235	2.2	1.26	13.1
	800	49	F091006008001300	145	248	269	2.6	1.26	14.8
	900	49	F091006009001300	163	279	302	2.9	1.26	16.5
	1000	49	F091006010001300	181	310	336	3.2	1.26	18.2
	1100	49	F091006011001300	199	341	369	3.5	1.26	19.9
	1200	49	F091006012001300	217	372	402	3.8	1.26	21.6
	1400	49	F091006014001300	253	434	470	4.5	1.26	23.8
	1600	49	F091006016001300	289	496	537	5.1	1.26	28.3
	1800	49	F091006018001300	326	558	604	5.8	1.26	31.7
	2000	49	F091006020001300	362	621	671	6.4	1.26	35.1
	2300	49	F091006023001300	416	714	772	7.4	1.26	41.3
	2600	49	F091006026001300	470	807	872	8.3	1.26	46.5
	3000	49	F091006030001300	542	931	1007	9.6	1.26	53.5
Tipas 20									
	400	104	F092006004000300	122	210	228	2.6	1.29	11.5
	500	104	F092006005000300	152	263	285	3.3	1.29	14.2
	600	104	F092006006000300	182	316	342	4.0	1.29	16.8
	700	104	F092006007000300	213	368	399	4.6	1.29	19.5
	800	104	F092006008000300	243	421	456	5.3	1.29	22.1
	900	104	F092006009000300	274	474	513	5.9	1.29	24.8
	1000	104	F092006010000300	304	526	570	6.6	1.29	27.4
	1100	104	F092006011000300	334	579	627	7.3	1.29	3.9



600

AUKŠTIS 600 mm	ILGIS	GYLIS		Galia (W) 45/35/20°C	Galia (W) 55/45/20°C	Galia (W) 60/45/20°C	TŪRIS (l)	N- ekspontas	SVORIS (kg)
	1200	104	F092006012000300	365	631	684	7.9	1.29	32.7
	1400	104	F092006014000300	426	737	798	9.2	1.29	38.4
	1600	104	F092006016000300	486	842	911	10.6	1.29	43.3
	1800	104	F092006018000300	547	947	1025	11.9	1.29	48.6
	2000	104	F092006020000300	608	1052	1139	13.2	1.29	53.9
	2300	104	F092006023000300	699	1210	1310	15.2	1.29	61.9
	2600	104	F092006026000300	790	1368	1481	17.2	1.29	69.8
	3000	104	F092006030000300	912	1579	1709	19.8	1.29	8.5
Tipas 30									
	400	154	F093006004000300	164	287	311	3.9	1.31	14.4
	500	154	F093006005000300	206	359	389	4.9	1.31	18.4
	600	154	F093006006000300	247	431	467	5.9	1.31	21.8
	700	154	F093006007000300	288	503	545	6.9	1.31	25.5
	800	154	F093006008000300	329	574	623	7.8	1.31	29.2
	900	154	F093006009000300	370	646	701	8.8	1.31	32.8
	1000	154	F093006010000300	411	718	778	9.8	1.31	36.5
	1100	154	F093006011000300	452	790	856	10.8	1.31	4.2
	1200	154	F093006012000300	493	862	934	11.8	1.31	43.9
	1400	154	F093006014000300	575	1005	1090	13.7	1.31	51.3
	1600	154	F093006016000300	658	1149	1245	15.7	1.31	58.7
	1800	154	F093006018000300	740	1292	1401	17.6	1.31	66.8
	2000	154	F093006020000300	822	1436	1557	19.6	1.31	73.5
	2300	154	F093006023000300	945	1651	1790	22.5	1.31	84.5
	2600	154	F093006026000300	1069	1867	2024	25.5	1.31	95.6
	3000	154	F093006030000300	1233	2154	2335	29.4	1.31	114



900

AUKŠTIS 900 mm	ILGIS	GYLIS		Galia (W) 45/35/20°C	Galia (W) 55/45/20°C	Galia (W) 60/45/20°C	TŪRIS (l)	N- ekspontas	SVORIS (kg)
Tipas 10									
	400	49	F091009004001300	99	171	185	1.8	1.28	11.3
	500	49	F091009005001300	124	214	231	2.3	1.28	13.8
	600	49	F091009006001300	149	256	277	2.7	1.28	16.3
	700	49	F091009007001300	173	299	324	3.1	1.28	18.9
	800	49	F091009008001300	198	342	370	3.6	1.28	21.4
	900	49	F091009009001300	223	384	416	4.0	1.28	23.9
	1000	49	F091009010001300	248	427	462	4.5	1.28	26.4
	1100	49	F091009011001300	272	470	508	5.0	1.28	29.0
	1200	49	F091009012001300	297	513	555	5.4	1.28	31.5
	1400	49	F091009014001300	347	598	647	6.3	1.28	36.5
	1600	49	F091009016001300	396	683	740	7.2	1.28	41.6
	1800	49	F091009018001300	446	769	832	8.1	1.28	46.6
	2000	49	F091009020001300	495	854	924	9.0	1.28	51.7
	2300	49	F091009023001300	570	982	1063	10.3	1.28	0.0
Tipas 20									
	400	104	F092009004000300	171	295	319	3.6	1.27	15.9
	500	104	F092009005000300	214	368	398	4.5	1.27	19.8
	600	104	F092009006000300	257	442	478	5.4	1.27	23.7
	700	104	F092009007000300	299	516	558	6.3	1.27	27.6
	800	104	F092009008000300	342	589	637	7.2	1.27	31.6
	900	104	F092009009000300	385	663	717	8.1	1.27	35.5
	1000	104	F092009010000300	428	736	797	9.0	1.27	39.4
	1100	104	F092009011000300	471	810	876	9.9	1.27	43.4
	1200	104	F092009012000300	513	884	956	10.8	1.27	47.3
	1400	104	F092009014000300	599	1031	1115	12.6	1.27	55.1



900

AUKŠTIS 900 mm	ILGIS	GYLIS		Galia (W) 45/35/20°C	Galia (W) 55/45/20°C	Galia (W) 60/45/20°C	TŪRIS (l)	N- ekspontas	SVORIS (kg)
	1600	104	F092009016000300	685	1178	1275	14.4	1.27	63.0
	1800	104	F092009018000300	770	1326	1434	16.2	1.27	78
	2000	104	F092009020000300	856	1473	1593	18.0	1.27	78.7
Tipas 30									
	400	154	F093009004000300	225	394	427	5.3	1.32	19.7
	500	154	F093009005000300	281	492	534	6.7	1.32	25.1
	600	154	F093009006000300	337	591	640	8.0	1.32	3.6
	700	154	F093009007000300	393	689	747	9.3	1.32	36.5
	800	154	F093009008000300	449	787	854	10.6	1.32	41.5
	900	154	F093009009000300	505	886	961	12.0	1.32	46.9
	1000	154	F093009010000300	561	984	1067	13.3	1.32	52.4
	1100	154	F093009011000300	618	1083	1174	14.6	1.32	57.9
	1200	154	F093009012000300	674	1181	1281	16.0	1.32	63.3
	1400	154	F093009014000300	786	1378	1494	18.6	1.32	74.2
	1600	154	F093009016000300	898	1575	1708	21.3	1.32	85.7
	1800	154	F093009018000300	1011	1772	1921	23.9	1.32	96.0
	2000	154	F093009020000300	1123	1968	2135	26.6	1.32	109.0