



**Datu lapa**

2026-05-23

# Compact ©

Augstas kvalitātes klasiskā tipa panelis radiators ar sānu pieslēgumu.

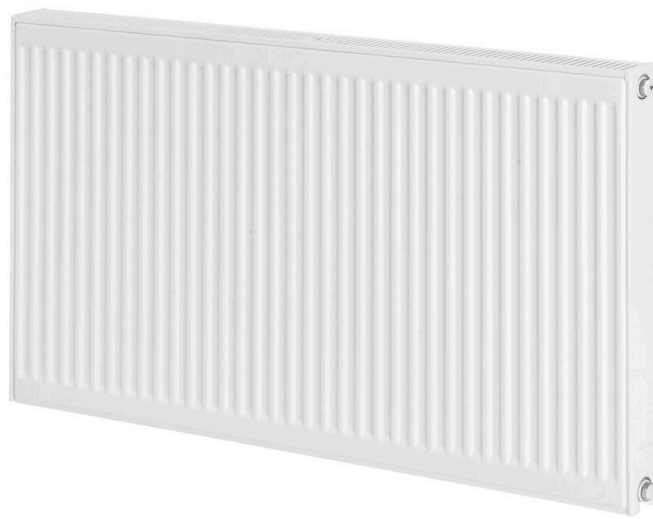

- ✓ Augsta spiediena izturība
- ✓ Estētisks dizains
- ✓ Elastīga uzstādīšana
- ✓ Vienmērīga siltuma sadale
- ✓ Plata krāsu izvēle

Compact ir klasiskā tipa paneļu radiators ar universālu dizainu un plašu izmēru klāstu; aprīkots ar sānu paneļiem, augšējo resti, bērnu drošības stiprinājumiem un pieejams RAL 9016 vai citos toņos.



### **Pielietojuma joma**

Piemērots dzīvojamām un komerciālām ēkām ar darba spiediena prasībām līdz 10 bar. Ideāls daudzstāvu ēkām un lielām instalācijām. Maksimālā darba temperatūra 110°C, 33,3 mm vertikālie kanāli.

### **Dimensiju noteikšana**

Lai nodrošinātu pareizu produktu izvēli, lūdzu, izmantojiet mūsu kalkulatoru rīkus un produktu bukletus. Ja nepieciešama palīdzība, sazinieties ar mūsu pārdošanas komandu.

### **Lietošana**

Uzstādi radiatoru, izmantojot MCW-7 sienas kronšteinus stabilitātei, pievieno sistēmai caur četriem sānu G 1/2 collu pieslēgumiem, veic regulāru apkopi un ievēro maksimālo darba spiedienu 10 bar un temperatūru līdz 110 grādiem.

### **AMA teksts**

Compact radiators paredzēts augstspiediena apkures sistēmām ar darba spiedienu līdz 10 bar un temperatūru līdz 110°C. Izgatavots no PN-EN 10130 sertificēta auksti velmēta tērauda. Konstrūcijā iekļauti vertikāli ūdens kanāli 33,3 mm solī, sānu paneli un augšējā reste. Pieslēgumi: 4×G 1/2". Piegādes komplektā sienas stiprinājumi, aizbāžņi un atgaisošanas vārsts. Standarta krāsa RAL 9016, citi toņi pēc pasūtījuma.



# Specifikācijas

ĪPAŠĪBAS	VIENĪBA	VĒRTĪBAS
ETIM klase		EC011022
Materiāls		Tērauds
Tips		11, 21, 22, 33
Virsmas struktūra		Profilēts
Maks. darba spiediens	bar	10
Standarta pieslēgumu skaits		4
Siltuma atdeve pēc EN 442 atzītas laboratorijas		Jā
Maksimālā darbības temperatūra	°C	110
Standarta krāsa		Jā
Krāsa		Balts
RAL numurs		9016
Restes/Vāka plāksne		Jā
Restes/Vāka plāksne		Jā
Spīduma vērtība		Spīdīgs
Vītnes izmērs (collas)		1/2 inch
Pieslēguma vītne		lekšējā vītne
Ar vienpunkta pieslēgumu		Jā
Ar ventilācijas pieslēgumu		Jā
Ar ventilācijas vārstu/gaisa atgaisotāju		Jā
Ar iztukšošanas iespēju		Jā



# Resursi



ProductImage - Purmo Compact, C, product image 30 degrees.



DimensionalDrawing - Radiatora stiprināšanas instrukcija

COMPACT (mm)				
	C11		C21s, C22, C33	
A	a1	a2	a1	a2
400-1600	117	-	133	-
1800	117	917	133	900
2000	117	1017	133	1000
2300	117	1150	133	1167
2600	117	1317	133	1300
3000	117	1517	133	1500

DimensionalDrawing - Compact, tabulas rasējums A

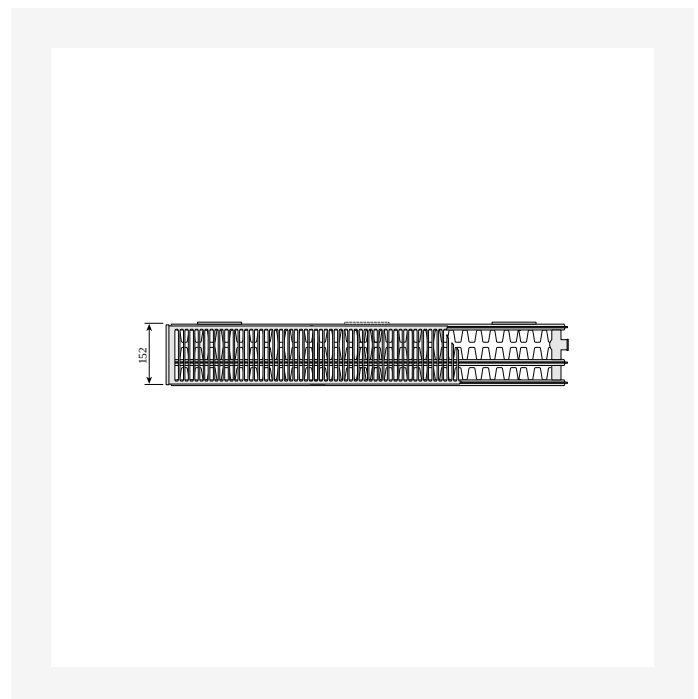

DimensionalDrawing - Compact, tips 33, skats no augšas



# Resursi

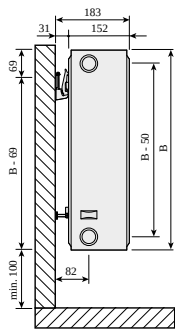

DimensionalDrawing - Compact, tips 33, skats no sāniem ar SSMS sienas kronšteinu

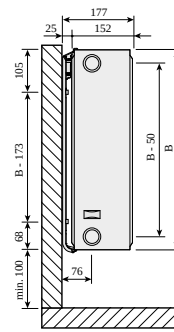

DimensionalDrawing - Compact, tips 33, skats no sāniem ar Monclac sienas kronšteinu



DimensionalDrawing - Compact, tips 22, skats no augšas

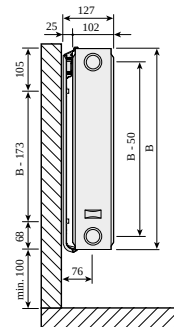

DimensionalDrawing - Compact, tips 22, skats no sāniem ar Monclac sienas kronšteinu



# Resursi

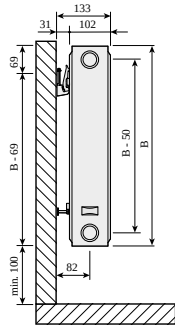

DimensionalDrawing - Compact, tips 22, skats no sāniem ar SSMS sienas kronšteiniem

DimensionalDrawing - Compact, tips 21, skats no augšas

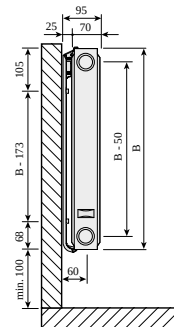
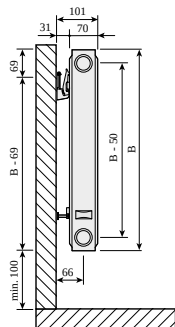

DimensionalDrawing - Compact, tips 21, skats no sāniem ar SSMS sienas kronšteiniem

DimensionalDrawing - Compact, tips 21, skats no sāniem ar Monclac sienas kronšteiniem



# Resursi

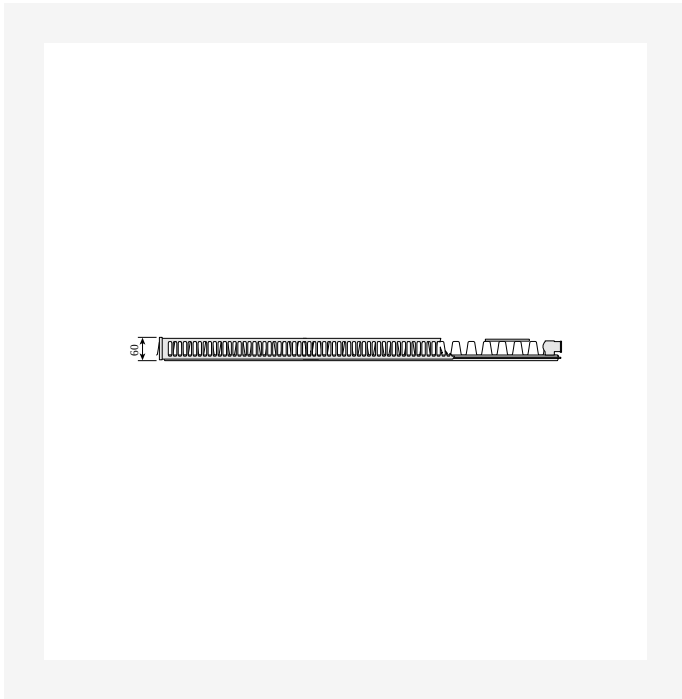

DimensionalDrawing - Compact, tips 11, skats no augšas

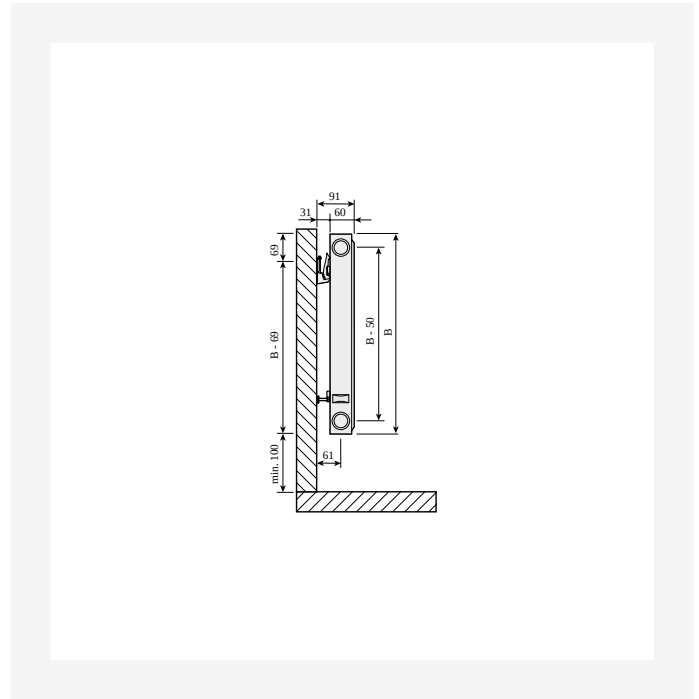

DimensionalDrawing - Compact, tips 11, skats no sāniem ar SSMS sienas kronšteinu

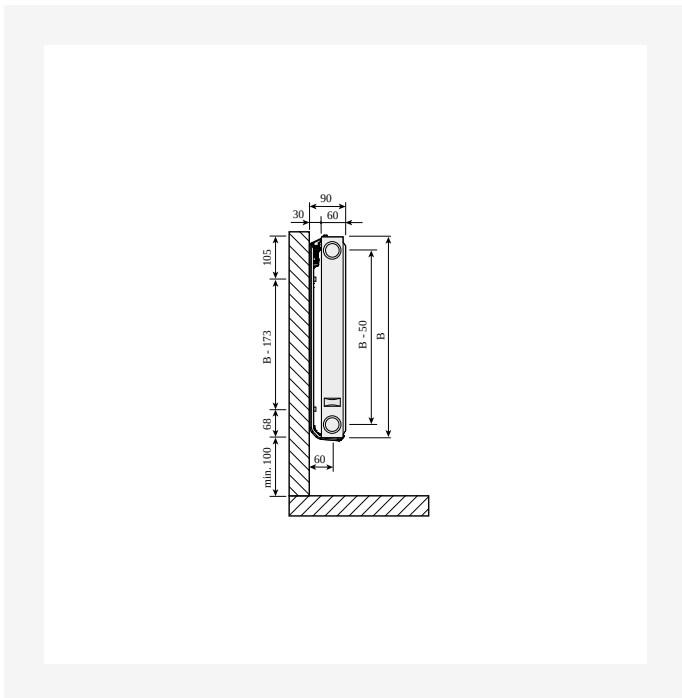

DimensionalDrawing - Compact, tips 11, skats no sāniem ar Monclac sienas kronšteinu

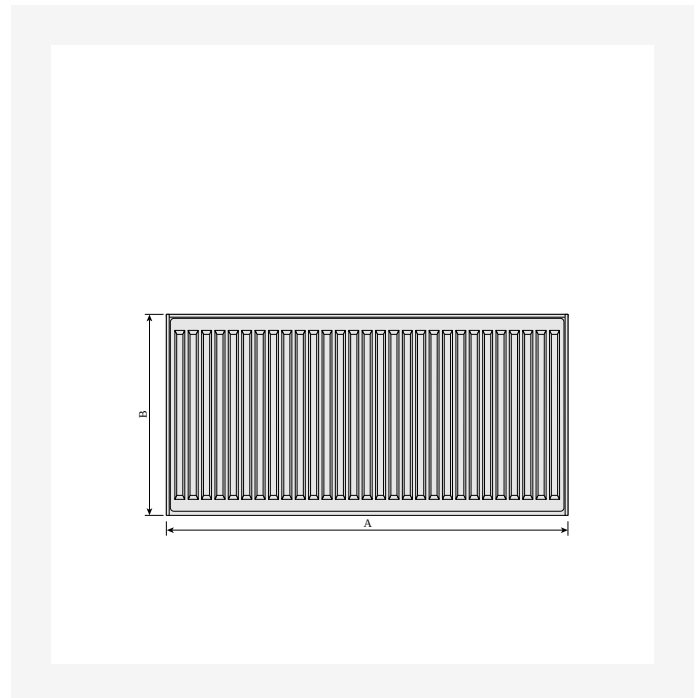

DimensionalDrawing - Compact, skats no priekšpuses



# Resursi

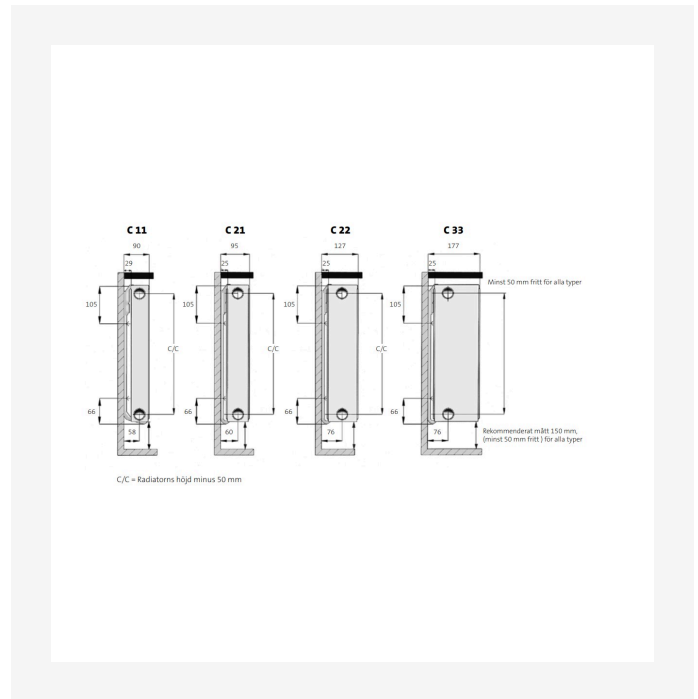
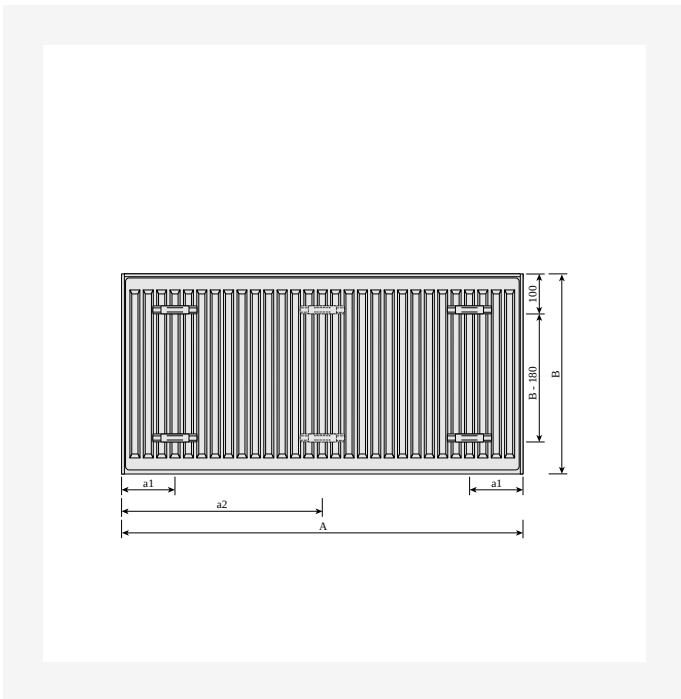

DimensionalDrawing - Compact, skats no aizmugures

DimensionalDrawing - Uzstādīšanas izmēri

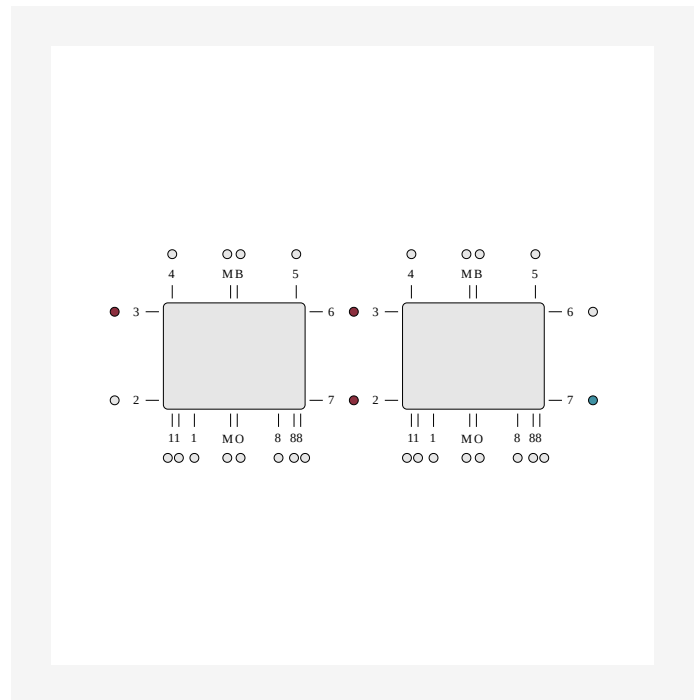
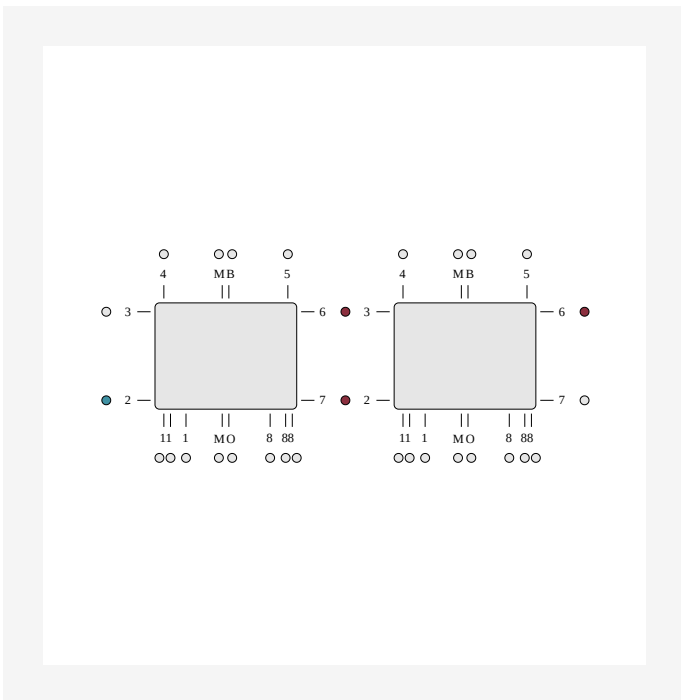

DimensionalDrawing - ETIM 62 sērijveida horizontālais pieslēgums

DimensionalDrawing - ETIM 37 sērijveida horizontālais pieslēgums



# Resursi

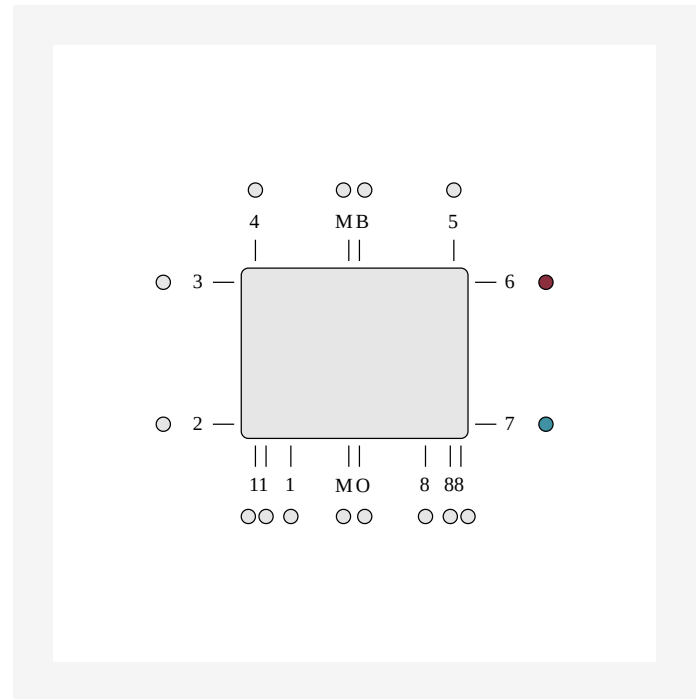
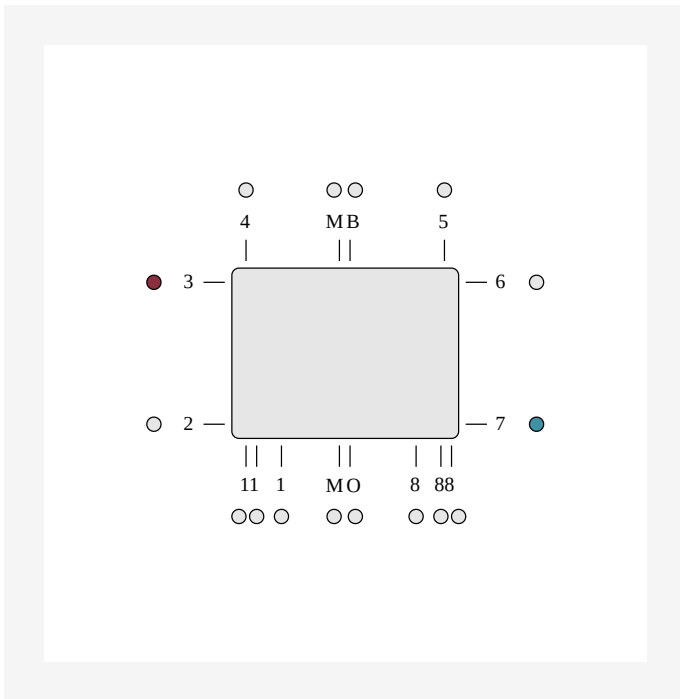

DimensionalDrawing - Diagonāls pieslēgums ETIM 37. Diagonālam pieslēgumam nepieciešams ārējs vārsts. Diagonāla pieslēguma gadījumā apakšējie pieslēgumi ir noslēgti.

DimensionalDrawing - Sānu pieslēgums ETIM 67. Sānu pieslēgumam nepieciešams ārējs radiatora savienojums vai vārsts. Sānu pieslēguma gadījumā apakšējie pieslēgumi ir noslēgti.

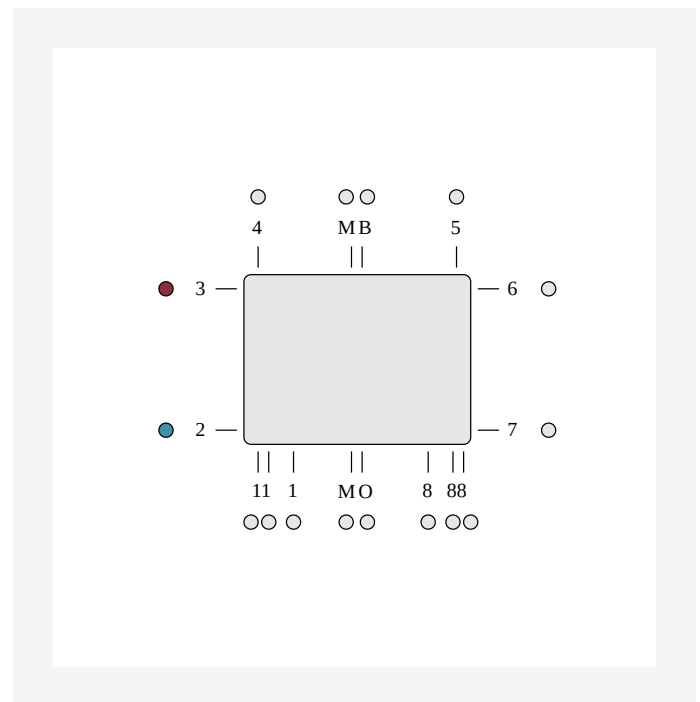
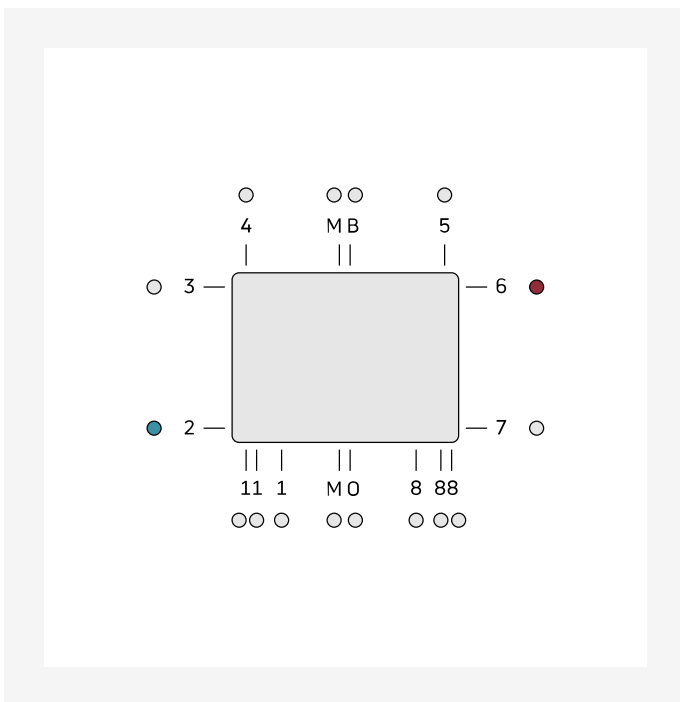

DimensionalDrawing - Diagonāls pieslēgums ETIM 62. Diagonālam pieslēgumam nepieciešams ārējs vārsts. Diagonāla pieslēguma gadījumā apakšējie pieslēgumi ir noslēgti.

DimensionalDrawing - Sānu pieslēgums ETIM 32. Sānu pieslēgumam nepieciešams ārējs radiatora vārsts. Sānu pieslēguma gadījumā apakšējie pieslēgumi ir noslēgti.



# Saistītie produkti



Sensors



Top Grill ©



Air



Gaisa ventilis un aklā aizbāžņa komplekts



Remonta krāsa



Sānu panelis ©



Sienas kronšteins Monclac



Gaisa ventilēšanas atslēga



Evosense



Atgaitas vārsts RV





# 300

AUGSTUMS 300 mm	GARUMS DZIĻUMS		Jauda (W) 45/35/20°C	Jauda (W) 55/45/20°C	Jauda (W) 60/45/20°C	TILPUMS (l)	N- ekponents	SVARS (kg)
<b>Tips 11</b>								
400	60	F061103004010300	65	113	122	0.7	1.30	4.4
600	60	F061103006010300	97	169	183	1.0	1.30	5.9
700	60	F061103007010300	113	197	213	1.2	1.30	6.7
800	60	F061103008010300	129	225	244	1.4	1.30	7.5
900	60	F061103009010300	146	253	274	1.5	1.30	8.3
1100	60	F061103011010300	178	309	335	1.9	1.30	10.0
1200	60	F061103012010300	194	338	366	2.0	1.30	1.6
1400	60	F061103014010300	226	394	427	2.4	1.30	12.2
1600	60	F061103016010300	259	450	488	2.7	1.30	13.8
2000	60	F061103020010300	323	563	610	3.4	1.30	17.0
2300	60	F061103023010300	372	647	701	3.9	1.30	19.4
3000	60	F061103030010300	485	844	914	5.1	1.30	24.9
<b>Tips 21</b>								
400	70	F062103004010300	92	158	171	1.4	1.28	6.2
600	70	F062103006010300	137	237	257	2.0	1.28	8.6
800	70	F062103008010300	183	317	343	2.7	1.28	11.3
1200	70	F062103012010300	275	475	514	4.1	1.28	16.4
1400	70	F062103014010300	321	554	600	4.8	1.28	18.7
1800	70	F062103018010300	412	712	771	6.1	1.28	23.6
2300	70	F062103023010300	527	910	985	7.8	1.28	30.0
3000	70	F062103030010300	687	1187	1285	10.2	1.28	38.7
<b>Tips 22</b>								
500	102	F0622030005010300	141	246	267	1.7	1.31	8.5
600	102	F0622030006010300	169	295	320	2.0	1.31	10.1



# 300

AUGSTUMS 300 mm	GARUMS	DZIĻUMS		Jauda (W) 45/35/20°C	Jauda (W) 55/45/20°C	Jauda (W) 60/45/20°C	TILPUMS (l)	N- ekponents	SVARS (kg)
	900	102	F062203009010300	253	443	480	3.1	1.31	14.2
	1400	102	F062203014010300	394	689	747	4.8	1.31	21.3
	1600	102	F062203016010300	451	788	854	5.4	1.31	24.2
	2300	102	F062203023010300	648	1132	1228	7.8	1.31	34.1
	3000	102	F062203030010300	845	1477	1601	10.2	1.31	44.9
<b>Tips 33</b>									
	400	152	F063303004010300	157	275	299	2.0	1.31	1.3
	700	152	F063303007010300	275	482	523	3.6	1.31	16.7
	800	152	F063303008010300	314	551	597	4.1	1.31	18.8
	900	152	F063303009010300	354	620	672	4.6	1.31	2.9
	1000	152	F063303010010300	393	688	747	5.1	1.31	23.5
	1100	152	F063303011010300	432	757	821	5.6	1.31	25.2
	1200	152	F063303012010300	472	826	896	6.1	1.31	27.3
	1600	152	F063303016010300	629	1101	1195	8.2	1.31	35.8
	2000	152	F063303020010300	786	1377	1493	10.2	1.31	44.3
	3000	152	F063303030010300	1179	2065	2240	15.3	1.31	65.6



## 400

AUGSTUMS 400 mm	GARUMS DZIĻUMS			Jauda (W) 45/35/20°C	Jauda (W) 55/45/20°C	Jauda (W) 60/45/20°C	TILPUMS (l)	N- ekponents	SVARS (kg)
<b>Tips 11</b>									
	400	60	F061104004010300	84	146	158	0.9	1.30	5.5
	500	60	F061104005010300	105	183	198	1.1	1.30	6.5
	700	60	F061104007010300	147	256	277	1.5	1.30	8.7
	1000	60	F061104010010300	210	366	396	2.2	1.30	11.8
	1100	60	F061104011010300	231	402	436	2.4	1.30	12.9
	1400	60	F061104014010300	294	512	555	3.1	1.30	16.1
	1600	60	F061104016010300	335	585	634	3.5	1.30	18.2
	1800	60	F061104018010300	377	658	713	4.0	1.30	2.4
	2300	60	F061104023010300	482	841	911	5.1	1.30	25.7
	3000	60	F061104030010300	629	1097	1188	6.6	1.30	33.2
<b>Tips 21</b>									
	800	70	F062104008010300	229	398	431	3.6	1.29	14.5
	900	70	F062104009010300	258	448	485	4.0	1.29	16.2
	1100	70	F062104011010300	315	547	592	5.0	1.29	19.6
	1200	70	F062104012010300	344	597	646	5.4	1.29	21.3
	1400	70	F062104014010300	401	696	754	6.3	1.29	24.6
	1600	70	F062104016010300	458	796	862	7.2	1.29	28.3
<b>Tips 22</b>									
	500	102	F062204005010300	177	311	338	2.3	1.32	11.3
	600	102	F062204006010300	213	374	405	2.7	1.32	13.3
	900	102	F062204009010300	319	560	608	4.0	1.32	18.8
	1000	102	F062204010010300	355	623	675	4.5	1.32	2.7
	1400	102	F062204014010300	497	872	946	6.3	1.32	28.4
	1600	102	F062204016010300	568	996	1081	7.2	1.32	32.3
	1800	102	F062204018010300	639	1121	1216	8.1	1.32	36.1



# 400

AUGSTUMS 400 mm	GARUMS	DZIĻUMS		Jauda (W) 45/35/20°C	Jauda (W) 55/45/20°C	Jauda (W) 60/45/20°C	TILPUMS (l)	N- ekponents	SVARS (kg)
	2600	102	F062204026010300	923	1619	1756	11.7	1.32	51.6
	3000	102	F062204030010300	1064	1868	2026	13.5	1.32	59.2
<b>Tips 33</b>									
	400	152	F063304004010300	196	345	375	2.7	1.33	13.5
	1000	152	F063304010010300	490	863	937	6.7	1.33	3.8
	1400	152	F063304014010300	686	1209	1312	9.4	1.33	42.3
	2000	152	F063304020010300	981	1726	1874	13.4	1.33	59.6



## 450

AUGSTUMS 450 mm	GARUMS DZIĻUMS		Jauda (W) 45/35/20°C	Jauda (W) 55/45/20°C	Jauda (W) 60/45/20°C	TILPUMS (l)	N- ekponents	SVARS (kg)	
<b>Tips 11</b>									
	400	60	F061104504010300	93	162	176	1.0	1.30	6.4
	600	60	F061104506010300	139	243	264	1.5	1.30	8.9
	1000	60	F061104510010300	232	406	440	2.5	1.30	14.0
	1200	60	F061104512010300	279	487	528	3.0	1.30	16.5
	1800	60	F061104518010300	418	730	791	4.5	1.30	24.5
	2000	60	F061104520010300	465	811	879	5.0	1.30	26.6
	2300	60	F061104523010300	535	933	1011	5.8	1.30	3.4
	3000	60	F061104530010300	697	1217	1319	7.5	1.30	39.2
<b>Tips 21</b>									
	1400	70	F062104514010300	438	764	827	7.0	1.30	29.5
	2600	70	F062104526010300	814	1418	1537	13.0	1.30	53.8
	3000	70	F062104530010300	939	1636	1773	15.0	1.30	61.9
<b>Tips 22</b>									
	1400	102	F062204514010300	546	960	1041	7.0	1.32	33.7
	1600	102	F062204516010300	624	1097	1190	8.0	1.32	38.3
	2300	102	F062204523010300	897	1576	1711	11.5	1.32	54.5
	2600	102	F062204526010300	1014	1782	1934	13.0	1.32	61.4
	3000	102	F062204530010300	1169	2056	2231	15.0	1.32	7.6
<b>Tips 33</b>									
	400	152	F063304504010300	215	379	411	3.0	1.33	15.8
	800	152	F063304508010300	429	757	822	6.0	1.33	29.6
	1100	152	F063304511010300	590	1041	1131	8.3	1.33	39.9
	1600	152	F063304516010300	858	1515	1645	12.0	1.33	57.1
	1800	152	F063304518010300	966	1704	1850	13.5	1.33	64.1
	2300	152	F063304523010300	1234	2178	2364	17.3	1.33	81.2



# 450

AUGSTUMS 450 mm	GARUMS	DZIĻUMS		Jauda (W) 45/35/20°C	Jauda (W) 55/45/20°C	Jauda (W) 60/45/20°C	TILPUMS (l)	N- ekponents	SVARS (kg)
	3000	152	F063304530010300	1609	2840	3084	22.5	1.33	1074



# 500

AUGSTUMS 500 mm	GARUMS	DZIĻUMS		Jauda (W) 45/35/20°C	Jauda (W) 55/45/20°C	Jauda (W) 60/45/20°C	TILPUMS (l)	N- ekponents	SVARS (kg)
<b>Tips 11</b>									
	400	60	F061105004010300	102	178	193	1.1	1.31	6.5
	500	60	F061105005010300	127	223	241	1.4	1.31	7.8
	700	60	F061105007010300	178	312	338	1.9	1.31	16
	900	60	F061105009010300	229	401	434	2.4	1.31	13.3
	1100	60	F061105011010300	280	490	531	3.0	1.31	16.4
	1800	60	F061105018010300	459	801	869	4.9	1.31	25.7
	2300	60	F061105023010300	586	1024	1110	6.2	1.31	32.6
<b>Tips 21</b>									
	400	70	F062105004010300	136	237	257	2.2	1.31	9.6
	700	70	F062105007010300	237	415	450	3.9	1.31	15.9
	800	70	F062105008010300	271	474	514	4.4	1.31	18.1
	900	70	F062105009010300	305	533	578	5.0	1.31	2.1
	1400	70	F062105014010300	475	830	900	7.7	1.31	3.5
<b>Tips 22</b>									
	500	102	F062205005010300	212	373	405	2.8	1.33	13.7
	700	102	F062205007010300	297	522	567	3.9	1.33	18.6
	1000	102	F062205010010300	424	746	810	5.5	1.33	25.8
	1100	102	F062205011010300	466	821	891	6.0	1.33	28.3
	1400	102	F062205014010300	593	1045	1134	7.7	1.33	35.5
	1600	102	F062205016010300	678	1194	1296	8.8	1.33	4.3
	2000	102	F062205020010300	847	1493	1620	11.0	1.33	5.1
<b>Tips 33</b>									
	700	152	F063305007010300	407	719	781	5.7	1.34	27.6
	900	152	F063305009010300	523	925	1005	7.4	1.34	34.8
	1100	152	F063305011010300	639	1131	1228	9.0	1.34	42.4



# 500

AUGSTUMS 500 mm	GARUMS	DZIĻUMS	Jauda (W) 45/35/20°C	Jauda (W) 55/45/20°C	Jauda (W) 60/45/20°C	TILPUMS (l)	N- ekponents	SVARS (kg)	
	1200	152	F063305012010300	697	1233	1340	9.8	1.34	45.7
	1600	152	F063305016010300	930	1645	1786	13.1	1.34	6.2
	2000	152	F063305020010300	1162	2056	2233	16.4	1.34	74.7
	2600	152	F063305026010300	1511	2672	2902	21.3	1.34	96.6
	3000	152	F063305030010300	1743	3084	3349	24.6	1.34	111.9



# 550

AUGSTUMS 550 mm	GARUMS	DZIĻUMS		Jauda (W) 45/35/20°C	Jauda (W) 55/45/20°C	Jauda (W) 60/45/20°C	TILPUMS (l)	N- ekponents	SVARS (kg)
<b>Tips 11</b>									
	400	60	F061105504010300	111	193	210	1.2	1.31	7.3
	500	60	F061105505010300	138	242	262	1.5	1.31	8.8
	900	60	F061105509010300	249	435	472	2.7	1.31	14.7
	2300	60	F061105523010300	636	1112	1206	6.9	1.31	35.3
	2600	60	F061105526010300	719	1257	1363	7.8	1.31	39.8
<b>Tips 21</b>									
	400	70	F062105504010300	146	255	277	2.4	1.31	1.4
	500	70	F062105505010300	182	319	346	3.0	1.31	12.8
	800	70	F062105508010300	291	511	554	4.9	1.31	2.2
	1000	70	F062105510010300	364	638	692	6.1	1.31	25.6
	1200	70	F062105512010300	437	766	831	7.3	1.31	30.0
	1400	70	F062105514010300	510	893	969	8.5	1.31	34.9
	1800	70	F062105518010300	656	1149	1246	11.0	1.31	44.7
	2300	70	F062105523010300	838	1468	1592	14.0	1.31	56.9
	3000	70	F062105530010300	1093	1915	2076	18.3	1.31	74.9
<b>Tips 22</b>									
	500	102	F062205505010300	228	403	437	3.0	1.33	14.9
	600	102	F062205506010300	274	484	525	3.7	1.33	17.8
	700	102	F062205507010300	320	564	612	4.3	1.33	2.5
	800	102	F062205508010300	365	645	700	4.9	1.33	23.2
	1200	102	F062205512010300	548	967	1050	7.3	1.33	34.3
	1600	102	F062205516010300	731	1289	1400	9.8	1.33	45.3
	1800	102	F062205518010300	822	1451	1575	11.0	1.33	5.8
	2000	102	F062205520010300	913	1612	1750	12.2	1.33	56.3
	3000	102	F062205530010300	1370	2418	2625	18.3	1.33	83.9



# 550

AUGSTUMS 550 mm	GARUMS	DZIĻUMS	Jauda (W) 45/35/20°C	Jauda (W) 55/45/20°C	Jauda (W) 60/45/20°C	TILPUMS (l)	N- ekponents	SVARS (kg)	
<b>Tips 33</b>									
	400	152	F063305504010300	250	443	481	3.6	1.34	18.0
	500	152	F063305505010300	312	553	601	4.5	1.34	22.2
	600	152	F063305506010300	374	664	721	5.4	1.34	26.6
	700	152	F063305507010300	437	775	841	6.3	1.34	3.1
	900	152	F063305509010300	561	996	1082	8.1	1.34	38.3
	1000	152	F063305510010300	624	1106	1202	9.0	1.34	42.3
	1400	152	F063305514010300	873	1549	1683	12.6	1.34	58.6
	2000	152	F063305520010300	1248	2213	2404	18.0	1.34	83.0
	2600	152	F063305526010300	1622	2877	3125	23.4	1.34	109.4



# 600

AUGSTUMS 600 mm	GARUMS DZIĻUMS		Jauda (W) 45/35/20°C	Jauda (W) 55/45/20°C	Jauda (W) 60/45/20°C	TILPUMS (l)	N- ekponents	SVARS (kg)	
<b>Tips 11</b>									
	400	60	F061106004010300	119	208	226	1.3	1.31	7.9
	500	60	F061106005010300	149	260	282	1.6	1.31	9.5
	600	60	F061106006010300	179	313	339	1.9	1.31	11.1
	700	60	F061106007010300	208	365	395	2.2	1.31	12.7
	2000	60	F061106020010300	595	1042	1130	6.4	1.31	33.7
	2300	60	F061106023010300	685	1198	1299	7.4	1.31	38.6
<b>Tips 21</b>									
	600	70	F062106006010300	233	409	444	4.0	1.32	16.6
	700	70	F062106007010300	272	478	518	4.6	1.32	19.2
	900	70	F062106009010300	349	614	666	5.9	1.32	24.3
	1000	70	F062106010010300	388	682	740	6.6	1.32	26.8
	1200	70	F062106012010300	466	819	888	7.9	1.32	31.9
	1600	70	F062106016010300	621	1092	1184	10.6	1.32	42.1
	1800	70	F062106018010300	699	1228	1332	11.9	1.32	47.2
	2000	70	F062106020010300	777	1365	1481	13.2	1.32	52.3
	3000	70	F062106030010300	1165	2047	2221	19.8	1.32	77.8
<b>Tips 22</b>									
	700	102	F062206007010300	342	605	657	4.6	1.34	22.6
	800	102	F062206008010300	391	691	750	5.3	1.34	25.5
	900	102	F062206009010300	440	777	844	5.9	1.34	28.4
	1100	102	F062206011010300	537	950	1032	7.3	1.34	34.3
	1200	102	F062206012010300	586	1037	1126	7.9	1.34	37.2
	1400	102	F062206014010300	684	1209	1313	9.2	1.34	43.9
	1600	102	F062206016010300	782	1382	1501	10.6	1.34	49.0
	1800	102	F062206018010300	879	1555	1688	11.9	1.34	54.9



# 600

AUGSTUMS 600 mm	GARUMS	DZIĻUMS		Jauda (W) 45/35/20°C	Jauda (W) 55/45/20°C	Jauda (W) 60/45/20°C	TILPUMS (l)	N- ekponents	SVARS (kg)
	2000	102	F062206020010300	977	1728	1876	13.2	1.34	6.7
<b>Tips 33</b>									
	500	152	F063306005010300	333	592	643	4.9	1.35	24.5
	700	152	F063306007010300	466	828	900	6.9	1.35	33.3
	1100	152	F063306011010300	732	1301	1414	10.8	1.35	5.9
	1200	152	F063306012010300	798	1420	1543	11.8	1.35	55.2
	2000	152	F063306020010300	1331	2366	2571	19.6	1.35	9.4
	2600	152	F063306026010300	1730	3076	3343	25.5	1.35	116.7
	3000	152	F063306030010300	1996	3549	3857	29.4	1.35	134.3



## 900

AUGSTUMS 900 mm	GARUMS DZIĻUMS		Jauda (W) 45/35/20°C	Jauda (W) 55/45/20°C	Jauda (W) 60/45/20°C	TILPUMS (l)	N- ekponents	SVARS (kg)	
<b>Tips 11</b>									
	500	60	F061109005010300	208	364	395	2.3	132	14.3
	700	60	F061109007010300	291	510	553	3.1	132	19.2
	900	60	F061109009010300	374	655	711	4.0	132	24.2
	1000	60	F061109010010300	415	728	790	4.5	132	26.7
	1100	60	F061109011010300	457	801	869	5.0	132	29.2
	1200	60	F061109012010300	498	874	948	5.4	132	31.6
	1800	60	F061109018010300	747	1311	1422	8.1	132	46.5
	2300	60	F061109023010300	955	1675	1817	10.3	132	58.9
	2600	60	F061109026010300	1079	1893	2054	11.7	132	66.4
	3000	60	F061109030010300	1245	2185	2370	13.5	132	76.3
<b>Tips 21</b>									
	400	70	F062109004010300	212	376	408	3.6	134	16.7
	500	70	F062109005010300	265	470	510	4.5	134	2.6
	600	70	F062109006010300	318	563	612	5.4	134	24.3
	700	70	F062109007010300	371	657	714	6.3	134	28.6
	800	70	F062109008010300	424	751	816	7.2	134	31.8
	900	70	F062109009010300	477	845	918	8.1	134	35.6
	1000	70	F062109010010300	530	939	1020	9.0	134	39.5
	1400	70	F062109014010300	742	1315	1428	12.6	134	54.5
	1600	70	F062109016010300	849	1502	1632	14.4	134	62.8
	1800	70	F062109018010300	955	1690	1836	16.2	134	69.6
	3000	70	F062109030010300	1591	2817	3060	27.0	134	115.0
<b>Tips 22</b>									
	700	102	F062209007010300	469	836	909	6.3	136	33.2
	2000	102	F062209020010300	1339	2389	2598	18.0	136	91.6



# 900

AUGSTUMS 900 mm	GARUMS	DZIĻUMS	Jauda (W) 45/35/20°C	Jauda (W) 55/45/20°C	Jauda (W) 60/45/20°C	TILPUMS (l)	N- ekponents	SVARS (kg)	
<b>Tips 33</b>									
	400	152	F063309004010300	364	651	708	5.3	1.36	28.7
	500	152	F063309005010300	455	814	885	6.7	1.36	35.4
	600	152	F063309006010300	547	976	1062	8.0	1.36	42.9
	700	152	F063309007010300	638	1139	1239	9.3	1.36	48.8
	800	152	F063309008010300	729	1302	1416	10.6	1.36	55.5
	900	152	F063309009010300	820	1465	1593	12.0	1.36	62.3
	1200	152	F063309012010300	1093	1953	2124	16.0	1.36	82.0
	1400	152	F063309014010300	1275	2278	2478	19.0	1.36	96.0
	1600	152	F063309016010300	1457	2604	2832	21.3	1.36	111.3
	1800	152	F063309018010300	1640	2929	3186	23.9	1.36	122.6
	2000	152	F063309020010300	1822	3255	3540	26.6	1.36	136.0
	3000	152	F063309030010300	2733	4882	5310	39.9	1.36	207.0