



Datablad

2026-06-24

Ramo Compact Ventil (RCV)

Ramo Ventil Compact panel radiators are both versatile and stylish.



- ✓ Høj effektivitet
- ✓ Smart enhedsstyring via app
- ✓ Holdbart materiale
- ✓ Integreret ventil
- ✓ Elegant design

Ramo Ventil Compact is a traditional panel radiator with flat, profiled front for closed water-borne heating systems. White RAL 9016 finish.



Anvendelsesområde

Ramo Ventil Compact er egnet til lukkede vandbaserede varmesystemer, ideel til boliger og erhvervsbygninger. Den tilbyder fleksible installationsmuligheder med højder fra 200 til 900 mm og længder op til 3000 mm. Understøtter to-rørs drift og forskellige tilslutningssteder

Dimensionering

Produktvalg er baseret på rummets størrelse, ønsket termisk output og installationstype For detaljeret hjælp brug vores designservice eller se vores brochure

Anvendelse

Ramo Ventil Compact skal installeres i overensstemmelse med de medfølgende installationsinstruktioner Sørg for at radiatoren er monteret med de vedlagte vægbeslag Tilslut til

centralvarmesystemet ved hjælp af de integrerede ventiler Før første brug fyld og udluft radiatoren for at fjerne luftlommer Regelmæssig vedligeholdelse inkluderer kontrol af ventiler og periodisk udluftning for at sikre optimal ydeevne

AMA-tekst

Ramo Ventil Compact kombinerer effektiv opvarmning med fleksibel installation, velegnet til lukkede vandbaserede varmesystemer. Fås i højder fra 200 til 900 mm og længder op til 3000 mm, lavet af høj kvalitet koldvalset stål. Den indbyggede ventil understøtter 2-rørssystemer og forskellige tilslutningssteder, inklusive gulvtilslutninger. Radiatoren er designet til moderne æstetik med en slank frontpanel med horisontale linjer, tilgængelig i flere RAL farver. Ideel til bolig- og erhvervsapplikationer, sikrer optimal opvarmningsydelse og nem installation



Specifikationer

EGENSKABER	ENHED	VÆRDIER
ETIM-klasse		EC011022
Materiale		Stål
Type		11, 21, 22, 33
Overfladestruktur		Flad glat, Profileret
Maks. arbejdsstryk	bar	10
Antal standardtilslutninger		2
Varmeafgivelse iht. anerkendt EN 442-laboratorium		Ja
Maks. driftstemperatur	°C	110
Standardfarve		Ja
Farve		Hvid
RAL-nummer		9016
Gitter/Dækkplade		Ja
Gitter/Dækkplade		Ja
Glansværdi		Glansfuld
Gængedimension (tomme)		1/2 tomme
Tilslutning gevind		Intern gevind
Med etpunkttilslutning		Ja
Med udluftningstilslutning		Ja
Med udluftningsventil/aflufter		Ja
Med aftapningsmulighed		Ja



Dokumenter

DOKUMENTER	DOKUMENTTYPE	LINK
Taethedstest	Installation	https://asset.productmarketingcloud.com/api/assetstorage/3577_c37363c0-7a55-470a-bf93-031f44c77bbe
Varmeeffekt-beregner (EXCEL), panelradiatorer	TechDia	https://asset.productmarketingcloud.com/api/assetstorage/3577_2da398bb-5820-4a58-af2d-62333aa4e65e



Ressourcer



ProductImage - Panel radiator Ramo Ventil Compact, RCV.

RAMO VENTIL COMPACT (mm)		
	RCV11	
A	a1	a2
400-1600	117	-
1800	117	917
2000	117	1017
2300	117	1150
2600	117	1317
3000	117	1517

DimensionalDrawing - Ramo Ventil Compact, tabeltegning A

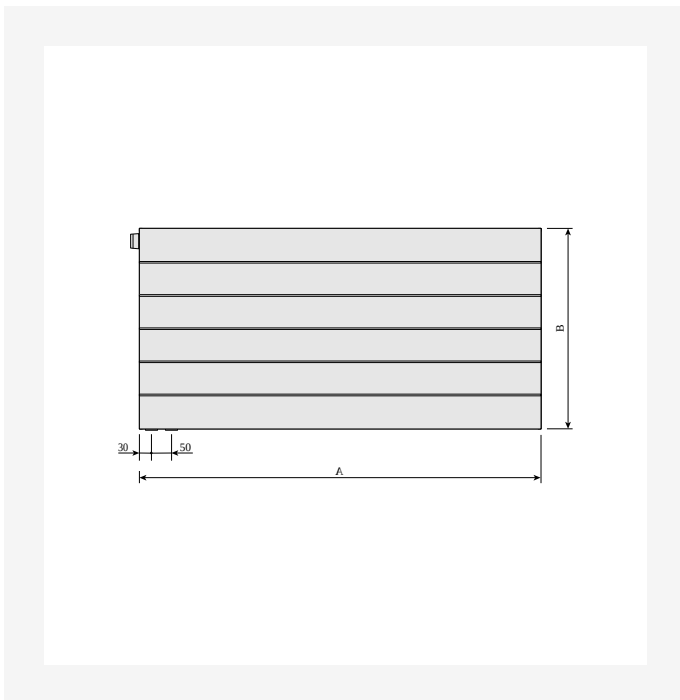

DimensionalDrawing - Ramo Ventil Compact, forfra, venstre

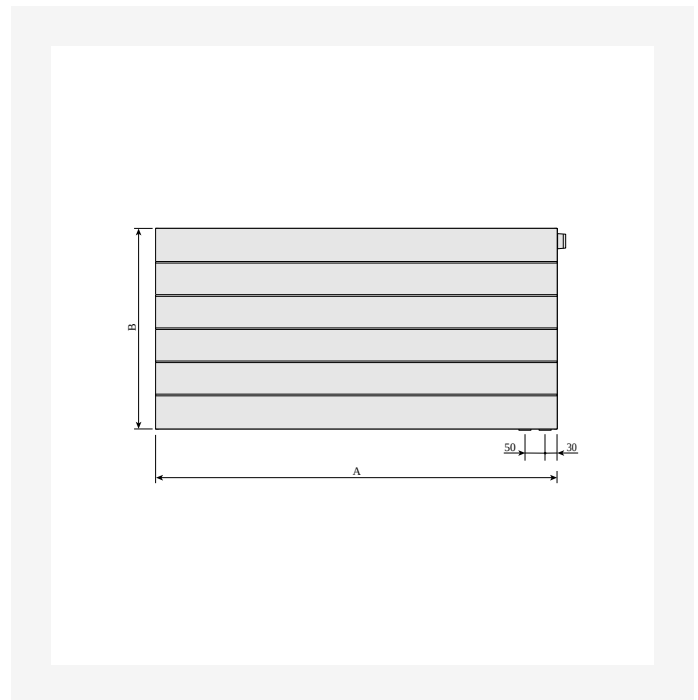

DimensionalDrawing - Ramo Ventil Compact, forfra, højre



Ressourcer



DimensionalDrawing - Plan Ventil Compact og Ramo Ventil Compact, type 33, højre, set oppefra

DimensionalDrawing - Plan Ventil Compact og Ramo Ventil Compact, type 33, venstre, set oppefra

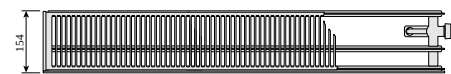
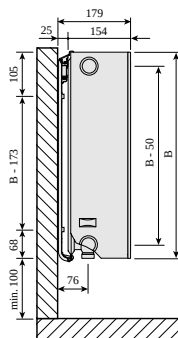

DimensionalDrawing - Plan Ventil Compact og Ramo Ventil Compact, typer 30-33, sidevisning

DimensionalDrawing - Plan Ventil Compact og Ramo Ventil Compact, type 30, højre, set oppefra



Ressourcer

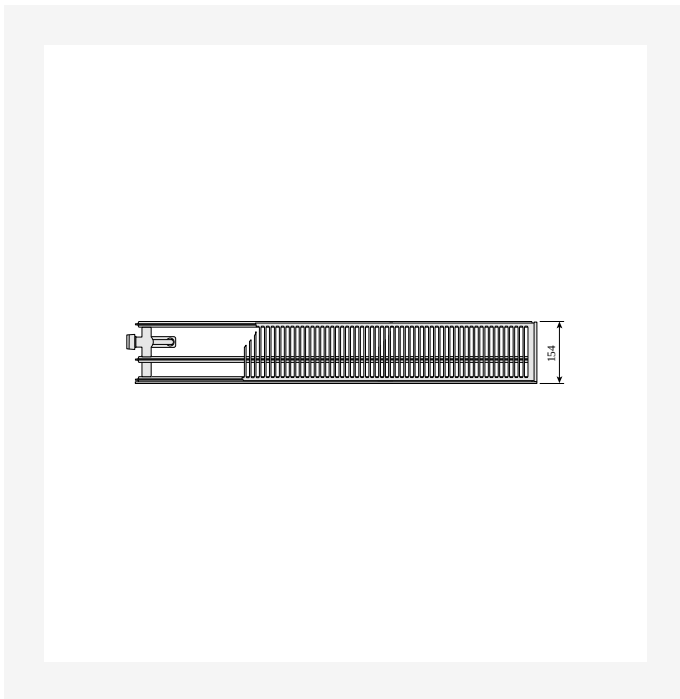

DimensionalDrawing - Plan Ventil Compact og Ramo Ventil Compact, type 30, venstre, set oppefra



DimensionalDrawing - Plan Ventil Compact og Ramo Ventil Compact, type 22, højre, set oppefra

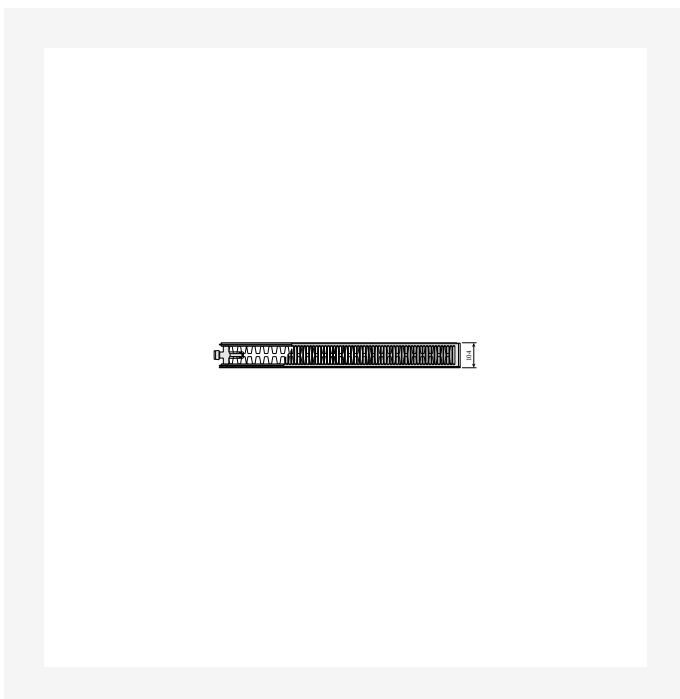

DimensionalDrawing - Plan Ventil Compact og Ramo Ventil Compact, type 22, venstre, set oppefra

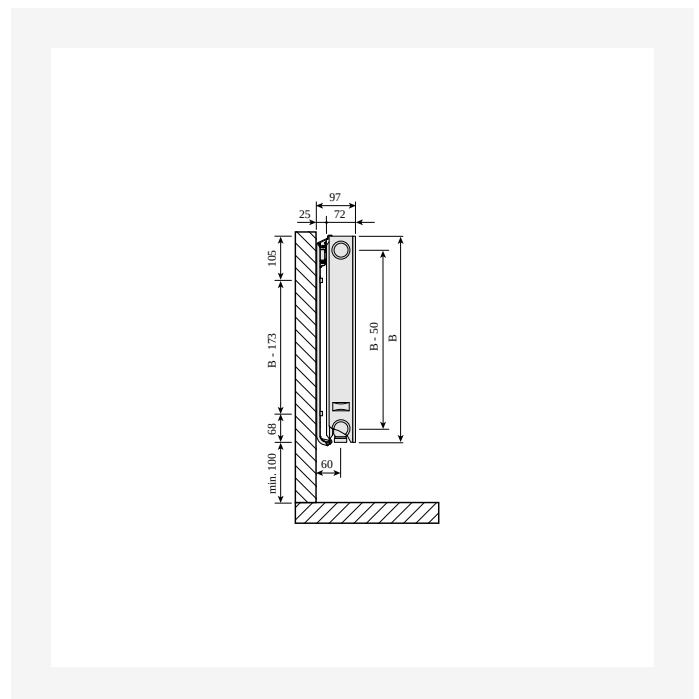

DimensionalDrawing - Plan Ventil Compact og Ramo Ventil Compact, type 21s, sidevisning



Ressourcer

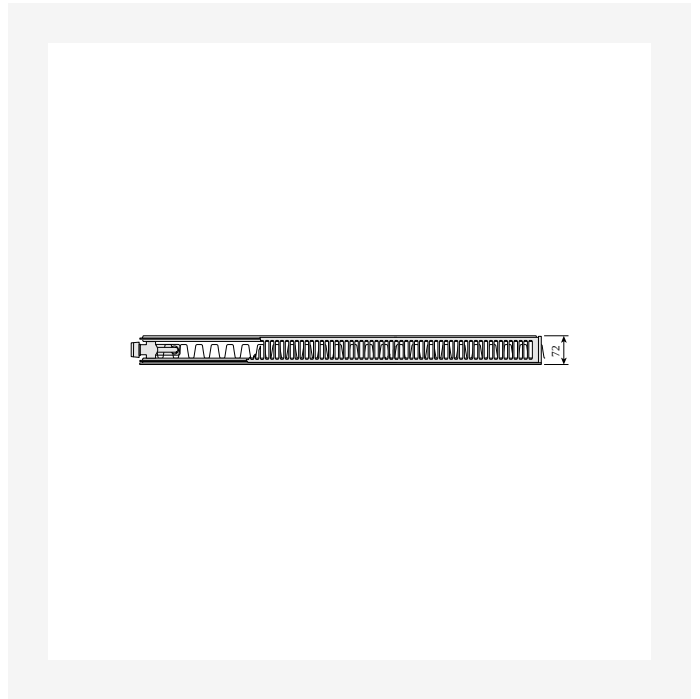
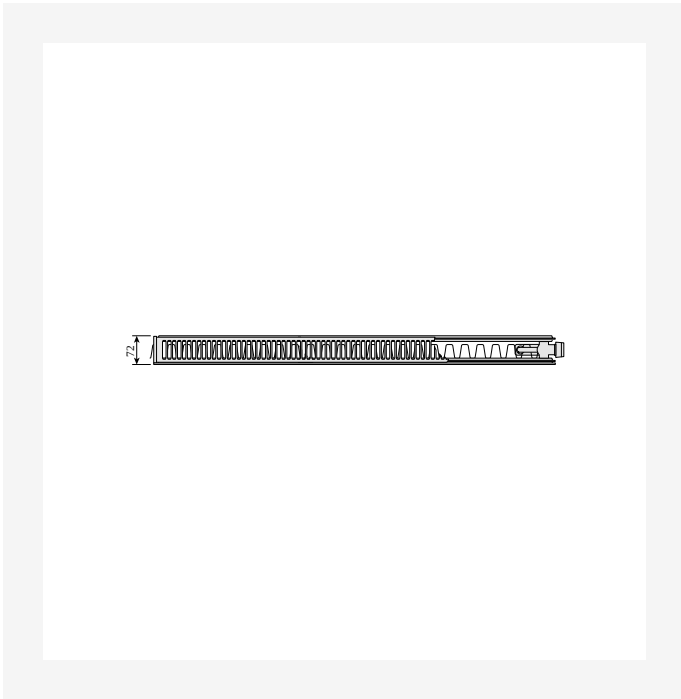

Dimensional Drawing - Plan Ventil Compact og Ramo Ventil Compact, type 21s, højre, set oppefra

Dimensional Drawing - Plan Ventil Compact og Ramo Ventil Compact, type 21s, venstre, set oppefra

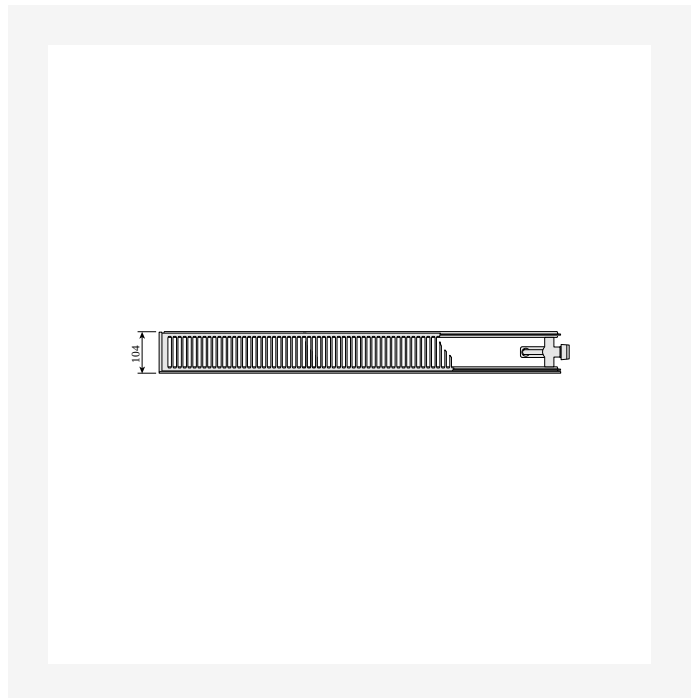
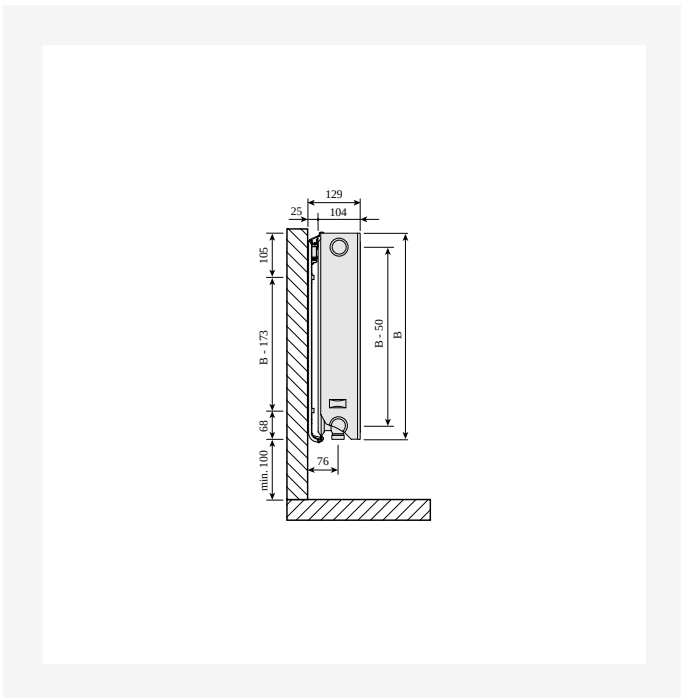

Dimensional Drawing - Plan Ventil Compact og Ramo Ventil Compact, typer 20-22, sidevisning

Dimensional Drawing - Plan Ventil Compact og Ramo Ventil Compact, type 20, højre, set oppefra



Ressourcer

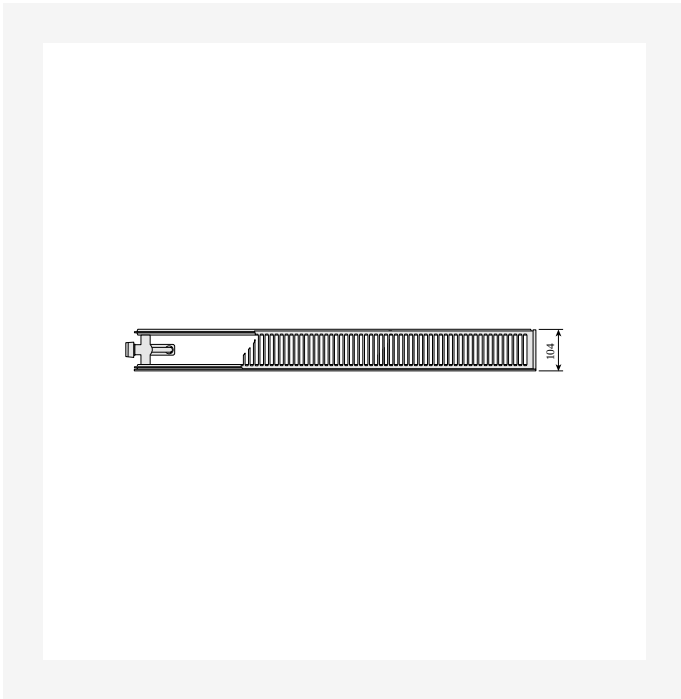

DimensionalDrawing - Plan Ventil Compact og Ramo Ventil Compact, type 20, venstre, set oppefra

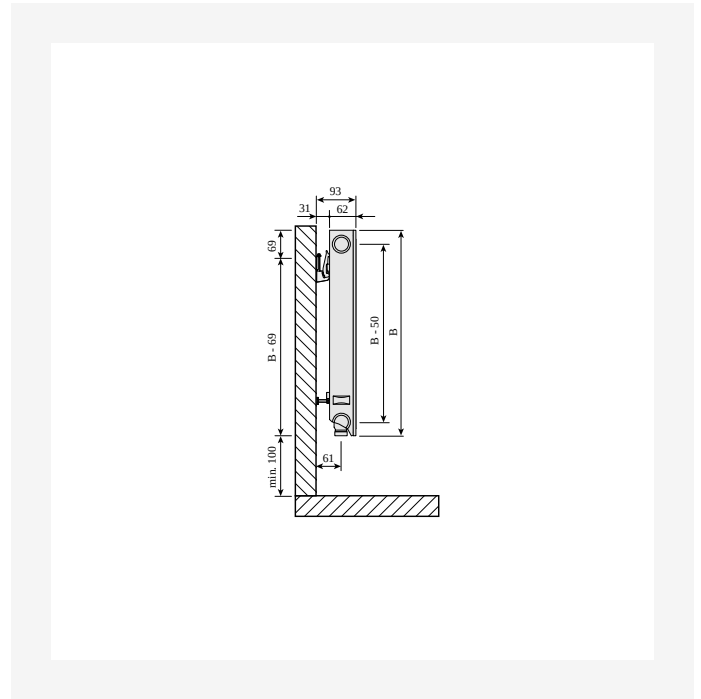

DimensionalDrawing - Plan Ventil Compact og Ramo Ventil Compact, type 11, sidevisning

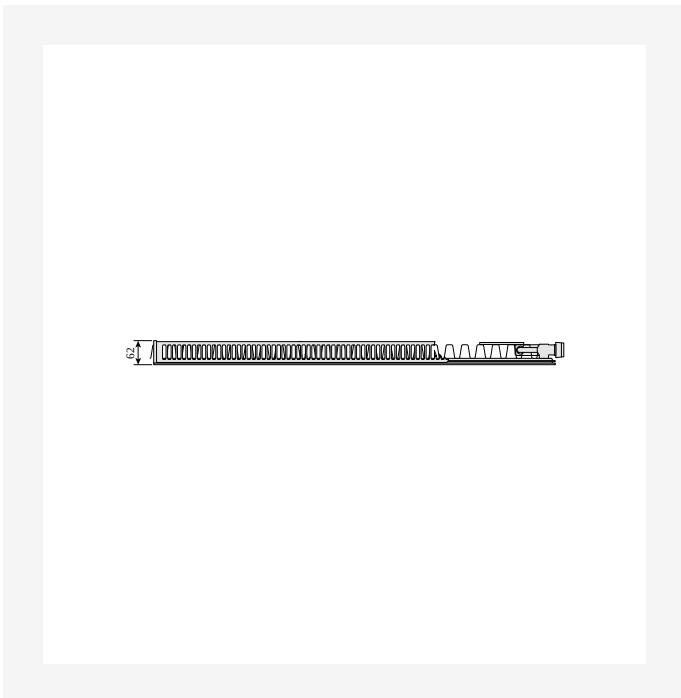

DimensionalDrawing - Plan Ventil Compact og Ramo Ventil Compact, type 11, højre, set oppefra

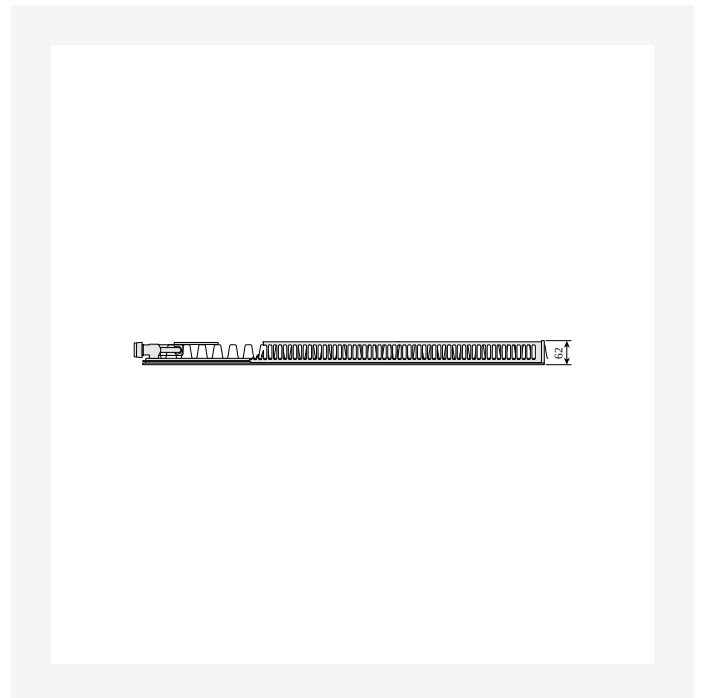

DimensionalDrawing - Plan Ventil Compact og Ramo Ventil Compact, type 11, venstre, set oppefra



Relaterede produkter

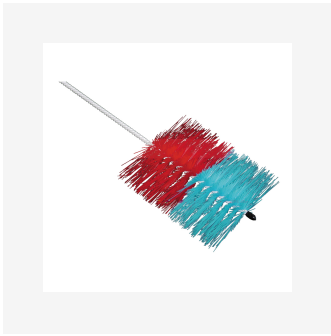



300

HØJDE 300 mm	LÆNGDE	DYBDE	Varenr./ VVS (V)	Varenr./ VVS(H)	EFFEKT (W) 45/35/20°C	EFFEKT (W) 55/45/20°C	EFFEKT (W) 60/45/20°C	VOLUMEN (l)	N- ekponent	VÆGT (kg)
Type 11										
	1600	62	328731816		254	440	476	2.7	1.28	18.3
	2000	62	328731820		318	550	595	3.4	1.28	22.5
	2600	62	328731826		413	715	773	4.4	1.28	28.9
	3000	62	328731830		477	824	892	5.1	1.28	33.1
Type 21										
	800	72	328733808		177	305	330	2.7	1.28	14.2
	1100	72	FOG2103011011310		243	419	453	3.7	1.28	0.0
	1600	72	328733816		353	610	660	5.4	1.28	25.8
Type 22										
	2300	104	328734883	328734823	637	1109	1202	7.8	1.30	4.1
Type 33										
	400	154	328736804		153	268	291	2.0	1.32	11.7
	500	154	328736805		191	335	364	2.5	1.32	14.5
	1000	154	328736810		383	671	728	5.1	1.32	25.9
	1600	154	328736816		612	1073	1164	8.2	1.32	4.1
	2600	154	328736826		995	1744	1892	13.3	1.32	63.8



400

HØJDE 400 mm	LÆNGDE	DYBDE	Varenr./ VVS (V)	Varenr./ VVS (H)	EFFEKT (W) 45/35/20°C	EFFEKT (W) 55/45/20°C	EFFEKT (W) 60/45/20°C	VOLUMEN (l)	N- ekponent	VÆGT (kg)
Type 11										
500	62		328741865		102	177	191	1.1	1.28	8.5
1100	62		FOG1104011010310	328741811	225	389	421	2.4	1.28	17.1
Type 21										
500	72		328743805		139	241	261	2.3	1.28	12.0
Type 22										
500	104		328744865		175	307	333	2.3	1.31	13.4
1100	104		328744811		386	675	732	5.0	1.31	27.0
3000	104		328744890	328744830	1053	1841	1996	13.5	1.31	7.5
Type 33										
800	154		328746808		385	677	734	5.4	1.32	28.7
900	154		328746809		433	761	826	6.0	1.32	31.3
1000	154		328746810		481	846	918	6.7	1.32	34.4
1600	154		328746876		769	1353	1469	10.7	1.32	53.6



500

HØJDE 500 mm	LÆNGDE	DYBDE	Varenr./ VVS	EFFEKT (W) 45/35/20°C	EFFEKT (W) 55/45/20°C	EFFEKT (W) 60/45/20°C	VOLUMEN (l)	N- ekponent	VÆGT (kg)
Type 11									
500	62	328751865	124	214	231	1.4	1.28	15	
600	62	328751866	148	256	278	1.6	1.28	12.3	
1400	62	328751814	346	598	648	3.8	1.28	26.4	
1800	62	328751878	445	769	833	4.9	1.28	33.4	
2300	62	328751823	569	983	1064	6.2	1.28	42.2	
Type 21									
900	72	328753809	299	518	561	5.0	1.29	24.6	
1000	72	328753810	332	576	623	5.5	1.29	27.2	
2000	72	328753820	664	1151	1247	11.0	1.29	52.5	
Type 22									
500	104	328754805	210	368	399	2.8	1.32	16.5	
600	104	328754806	251	442	479	3.3	1.32	19.3	
1400	104	328754814	587	1030	1118	7.7	1.32	41.9	
1600	104	328754876	670	1177	1277	8.8	1.32	47.5	
2300	104	328754823	964	1692	1836	12.7	1.32	67.2	
2600	104	328754826	1089	1913	2076	14.3	1.32	75.7	
Type 33									
500	154	328756865	286	505	548	4.1	1.33	22.8	
700	154	328756867	400	706	767	5.7	1.33	4.0	
800	154	328756808	457	807	877	6.6	1.33	35.2	
1600	154	328756816	914	1615	1753	13.1	1.33	67.6	
1800	154	328756818	1029	1817	1972	14.8	1.33	75.7	



600

HØJDE 600 mm	LÆNGDE	DYBDE	Varenr./ VVS (V)	Varenr./ VVS(H)	EFFEKT (W) 45/35/20°C	EFFEKT (W) 55/45/20°C	EFFEKT (W) 60/45/20°C	VOLUMEN (l)	N- ekponent	VÆGT (kg)
Type 11										
	400	62	328761864		115	200	216	1.3	1.28	1.3
	500	62	328761865		144	249	270	1.6	1.28	12.4
	600	62	328761806		173	299	324	1.9	1.28	14.6
	800	62	328761808		231	399	432	2.6	1.28	18.9
	1000	62	328761870		289	499	540	3.2	1.28	23.1
	1100	62	FOG1106011010310		317	549	594	3.5	1.28	25.2
	2600	62	328761826		750	1297	1404	8.3	1.28	57.2
Type 21										
	400	72	328763864		153	266	288	2.6	1.30	14.4
	900	72	328763869	328763809	344	598	648	5.9	1.30	29.7
	1200	72	328763872		458	797	863	7.9	1.30	38.8
Type 22										
	500	104	328764805		241	425	461	3.3	1.33	19.8
	1000	104	328764870		482	850	922	6.6	1.33	37.1
	1100	104	FOG2206011011310		530	935	1015	7.3	1.33	4.6
	1400	104	328764874		675	1190	1291	9.2	1.33	5.9
Type 33										
	1600	154	328766876		1050	1862	2022	15.7	1.34	8.9
	1800	154	328766878		1181	2094	2275	17.6	1.34	9.7



900

HØJDE 900 mm	LÆNGDE	DYBDE	Varenr./ VVS (V)	Varenr./ VVS(H)	EFFEKT (W) 45/35/20°C	EFFEKT (W) 55/45/20°C	EFFEKT (W) 60/45/20°C	VOLUMEN (l)	N- ekponent	VÆGT (kg)
Type 11										
	400	62	328791804		159	277	300	1.8	1.30	14.9
	900	62	328791809		358	624	676	4.0	1.30	31.1
	1000	62	328791870		398	693	751	4.5	1.30	34.3
	2300	62	328791883	328791823	--	1594	--	10.3	1.30	76.4
	2600	62	328791886	328791826	--	1802	--	11.7	1.30	86.1
	3000	62	328791890	328791830	--	2079	--	13.5	1.30	103.0
Type 21										
	2300	72	328793883	328793823	--	2050	--	20.7	1.34	113.5
	2600	72	328793886	328793826	--	2318	--	23.4	1.34	123.4
	3000	72	328793890	328793830	--	2674	--	27.0	1.34	141.6
Type 22										
	500	104	328794805		325	578	628	4.5	1.35	28.9
	900	104	F0G2209009011310		585	1040	1130	8.1	1.35	49.5
	2300	104	328794883	328794823	--	2657	--	20.7	1.35	121.4
	2600	104	328794886	328794826	--	3004	--	23.4	1.35	136.9
	3000	104	328794890	328794830	--	3466	--	27.0	1.35	157.4
Type 33										
	400	154	328796864		354	633	688	5.3	1.36	33.8
	600	154	328796866		531	949	1032	8.0	1.36	47.8
	800	154	328796868		708	1266	1377	10.6	1.36	62.6
	1200	154	328796812		1062	1898	2065	16.0	1.36	92.6
	1400	154	328796814		1239	2215	2409	18.6	1.36	111.1
	1600	154	328796876		1416	2531	2753	21.3	1.36	121.5
	1800	154	328796818		1593	2848	3097	23.9	1.36	136.3
	2300	154	328796883	328796823	--	3639	--	30.6	1.36	173.2



900

HØJDE 900 mm	LÆNGDE	DYBDE	Varenr./ VVS (V)	Varenr./ VVS (H)	EFFEKT (W) 45/35/20°C	EFFEKT (W) 55/45/20°C	EFFEKT (W) 60/45/20°C	VOLUMEN (l)	N- ekponent	VÆGT (kg)
	2600	154	328796886	328796826	--	4113	--	34.6	1.36	195.3
	3000	154	328796890	328796830	--	4746	--	39.9	1.36	224.7