



**Datablad**

2026-04-29

# Plint R (RCV-200mm)

With a height of 200 mm the Plint R panel radiator is very compact.



- ✓ Nem at vedligeholde
- ✓ integreret ventil sæt
- ✓ Fleksibel installation
- ✓ Nemt at montere
- ✓ Moderne design

Plint R is a traditional panel radiator with flat, profiled front for closed hydronic heating systems. Perfect under large windows. White RAL 9016 finish.



### Anvendelsesområde

Plint R er ideel til bolig- og erhvervsinstallationer, især i rum med store vinduer som showrooms. Med et maksimalt arbejdstryk på 10 bar og en maksimal temperatur på 110°C sikrer den både pålidelighed og ydeevne. Velegnet til installationer med 6 tilslutningsforbinelse og dimensioner fra 200 mm i højden til 600-3000 mm i længden

### Dimensionering

For hurtig produktvalg brug vores brochure eller benyt vores designservice til detaljerede beregninger og skræddersyede anbefalinger

### Anvendelse

For at sikre optimal ydeevne bør Plint R radiatoren installeres ved hjælp af enten vægbeslag eller

gulvstativer afhængigt af rummets specifikke krav. Det er vigtigt at sikre at alle seks tilslutningsforbinelse (4 side 2 bund) er korrekt tilsluttet og at det maksimale driftstryk og temperatur ikke overskrides. Periodisk vedligeholdelse indebærer rengøring af den glatte frontpanel for at opretholde effektivitet og udseende

### AMA-tekst

Plint R radiatoren er fremstillet af koldvalset stål i overensstemmelse med PN-EN 10130, 10131 og 442-1 standarder, med et maksimalt arbejdstryk på 10 bar og en maksimal temperatur på 110°C. Den har en horisontalt profileret frontpanel med en korrugeret bagpanel, 6 tilslutningsforbinelse (4 side, 2 bund) og fås i højder på 200 mm med længder fra 600 til 3000 mm. Udstyret med en fabriksmonteret termostatventil, er den designet til enten væg- eller gulvmontering. Alle radiatorer leveres som standard i RAL 9016, med andre farver tilgængelige efter anmodning



# Specifikationer

EGENSKABER	ENHED	VÆRDIER
ETIM-klasse		EC011022
Materiale		Stål
Type		21, 22, 33, 44
Overfladestruktur		Flad glat, Flad profileret
Maks. arbejdsstryk	bar	10
Antal standardtilslutninger		2
Varmeafgivelse iht. anerkendt EN 442-laboratorium		Ja
Maks. driftstemperatur	°C	110
Standardfarve		Ja
Farve		Hvid
RAL-nummer		9016
Gitter/Dækkplade		Ja
Gitter/Dækkplade		Ja
Glansværdi		Glansfuld
Gængedimension (tomme)		1/2 tomme
Tilslutning gevind		Intern gevind
Med etpunkttilslutning		Ja
Med udluftningstilslutning		Ja
Med udluftningsventil/aflufter		Ja
Med aftapningsmulighed		Ja



# Dokumenter

DOKUMENTER	DOKUMENTTYPE	LINK
Installationsmanual for væg- og gulvkonsoller for Plint radiators	User	<a href="https://asset.productmarketingcloud.com/api/assetstorage/3577_eaef6207-b2e6-4e25-845f-dab07cabcbc0">https://asset.productmarketingcloud.com/api/assetstorage/3577_eaef6207-b2e6-4e25-845f-dab07cabcbc0</a>
Tæthedstest	Installation	<a href="https://asset.productmarketingcloud.com/api/assetstorage/3577_c37363c0-7a55-470a-bf93-031f44c77bbe">https://asset.productmarketingcloud.com/api/assetstorage/3577_c37363c0-7a55-470a-bf93-031f44c77bbe</a>



# Ressourcer

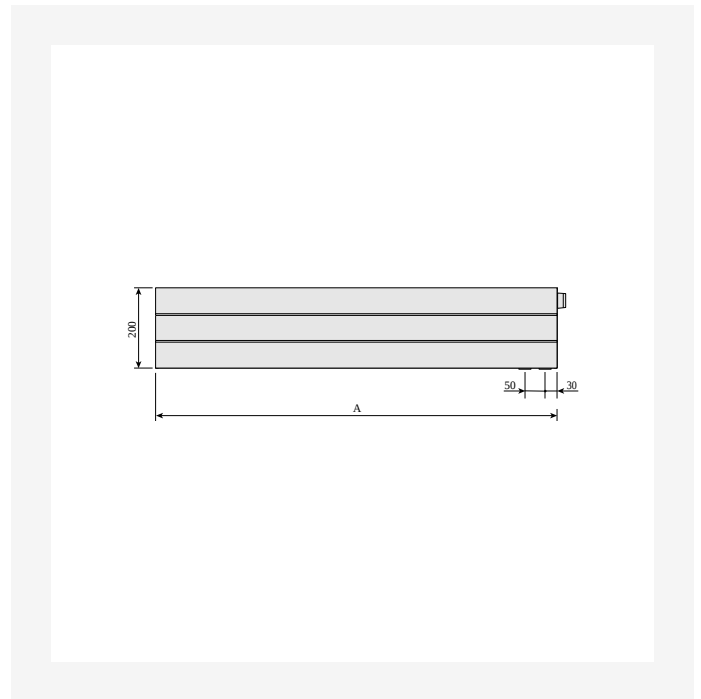

ProductImage - Panel radiator Plint R, 200 mm.

DimensionalDrawing - Plint R og Plint RD, forfra

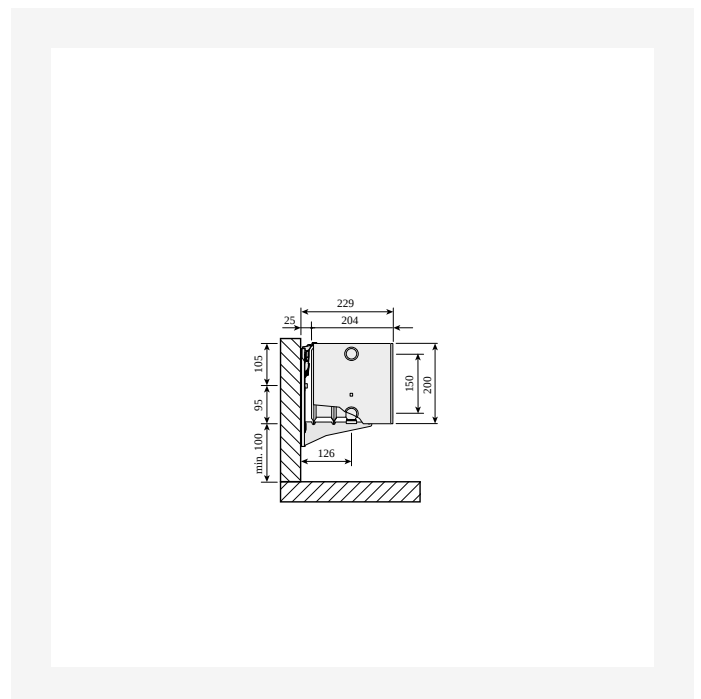
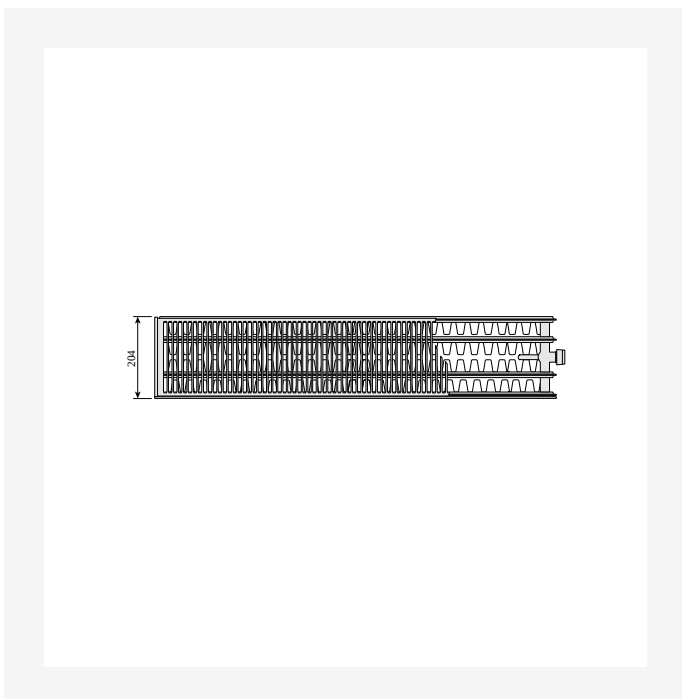

DimensionalDrawing - Plint P og Plint R, type 44, set oppefra

DimensionalDrawing - Plint P og Plint R, type 44, med Monclac vægbeslag, sidevisning



# Ressourcer

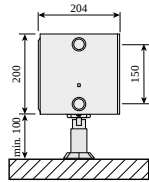

DimensionalDrawing - Plint P og Plint R, type 44, med gulvbeslag, sidevisning

DimensionalDrawing - Plint P og Plint R, type 33, set oppefra

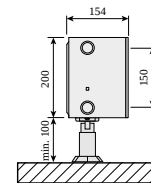
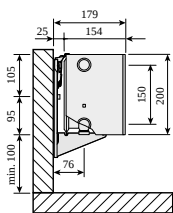

DimensionalDrawing - Plint P og Plint R, type 33, med Monclac vægbeslag, sidevisning

DimensionalDrawing - Plint P og Plint R, type 33, med gulvbeslag, sidevisning



# Ressourcer

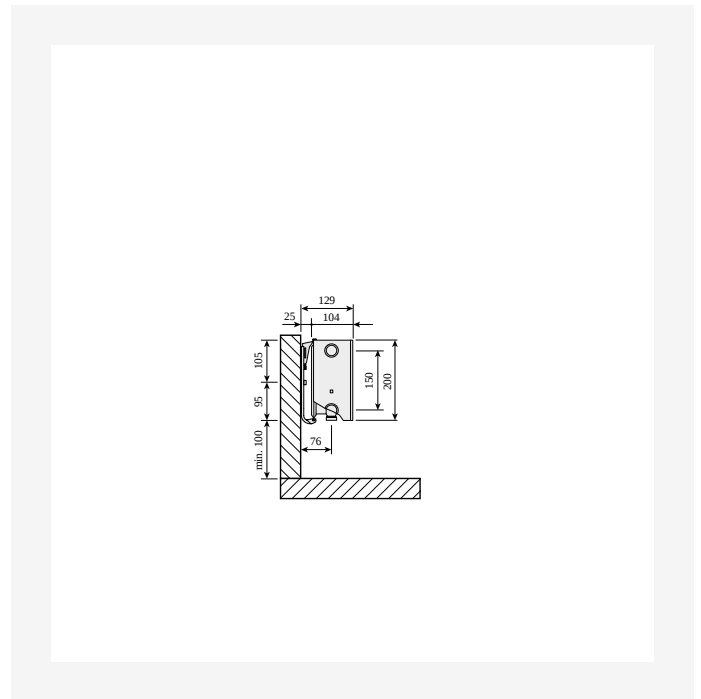
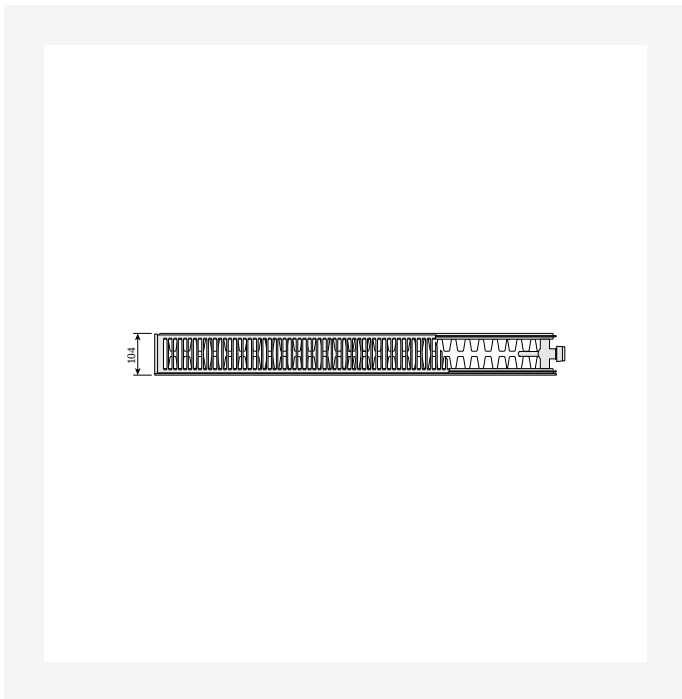

DimensionalDrawing - Plint P og Plint R, type 22, set oppefra

DimensionalDrawing - Plint P og Plint R, type 22, med Monclac vægbeslag, sidevisning

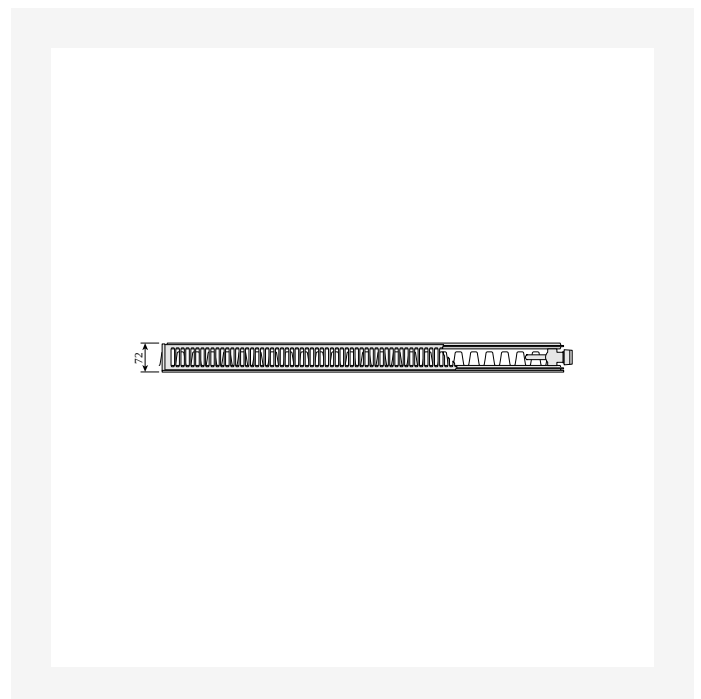
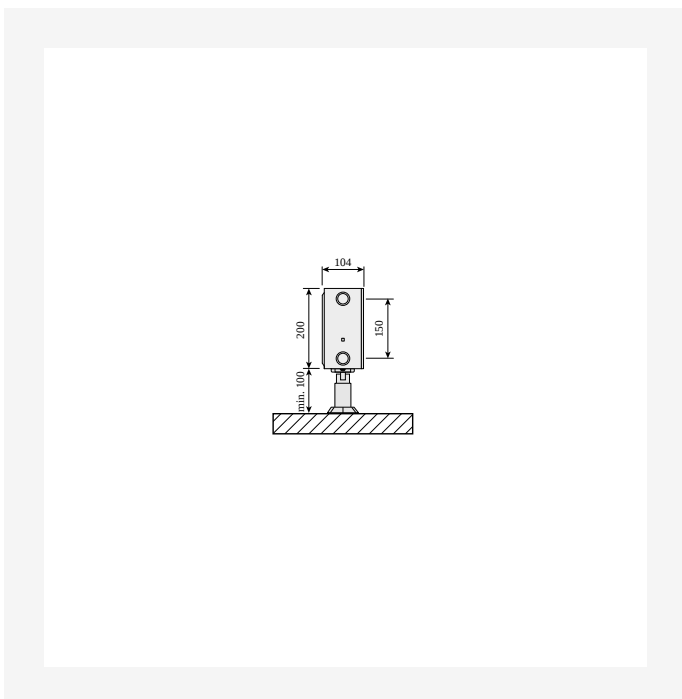

DimensionalDrawing - Plint P og Plint R, type 22, med gulvbeslag, sidevisning

DimensionalDrawing - Plint P og Plint R, type 21s, set oppefra



# Ressourcer

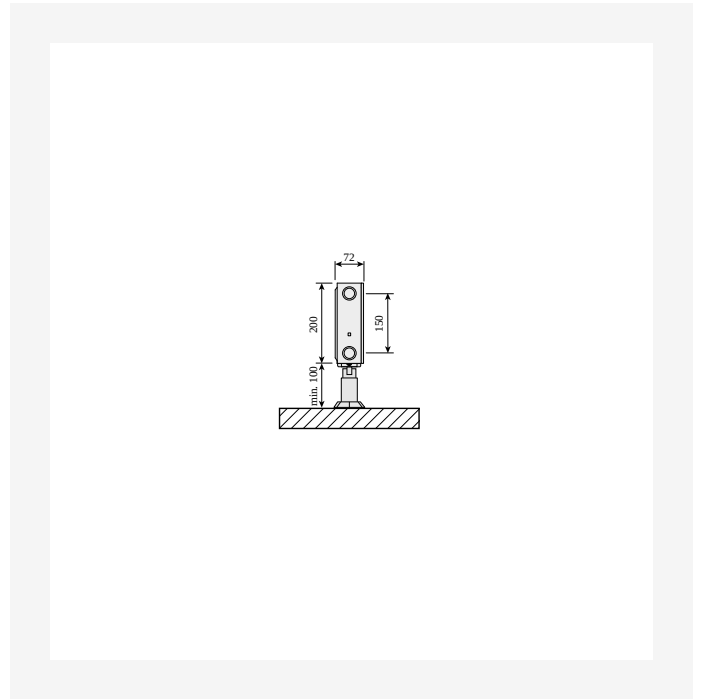
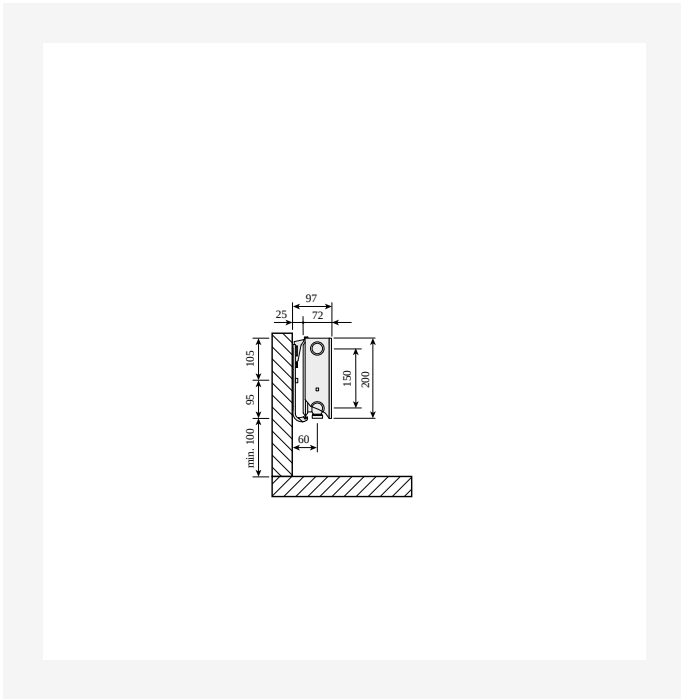

DimensionalDrawing - Plint P og Plint R, type 21s, med Monclac vægbeslag, sidevisning

DimensionalDrawing - Plint P og Plint R, type 21s, med gulvbeslag, sidevisning

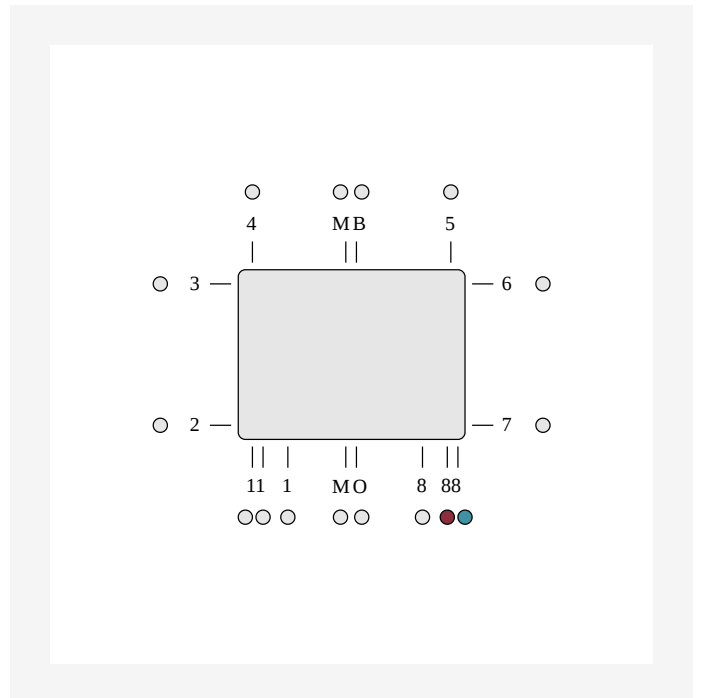
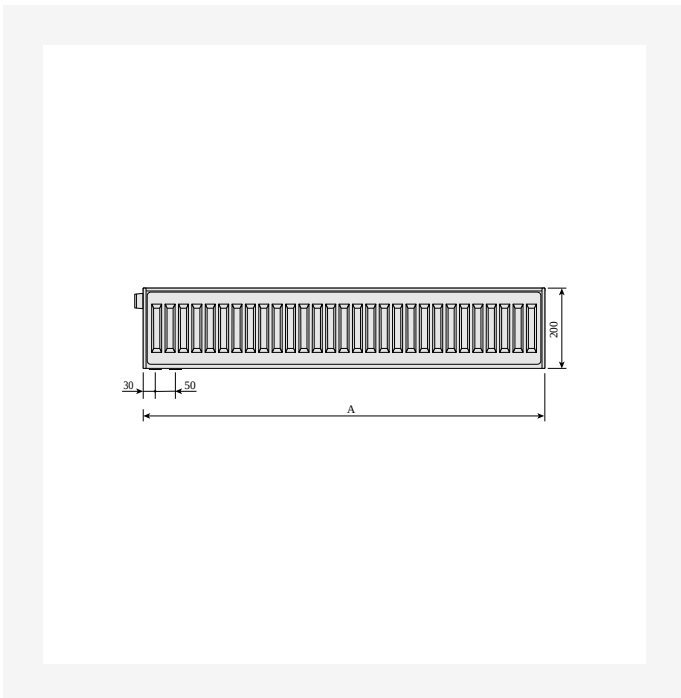

DimensionalDrawing - Plint, Plint P og Plint R, bagfra

DimensionalDrawing - ETIM 88 LR Bundtilslutning. Bundtilslutning via integreret ventil kræver brug af ventilindsats. Ubrugte tilslutninger er lukkede.



# Ressourcer

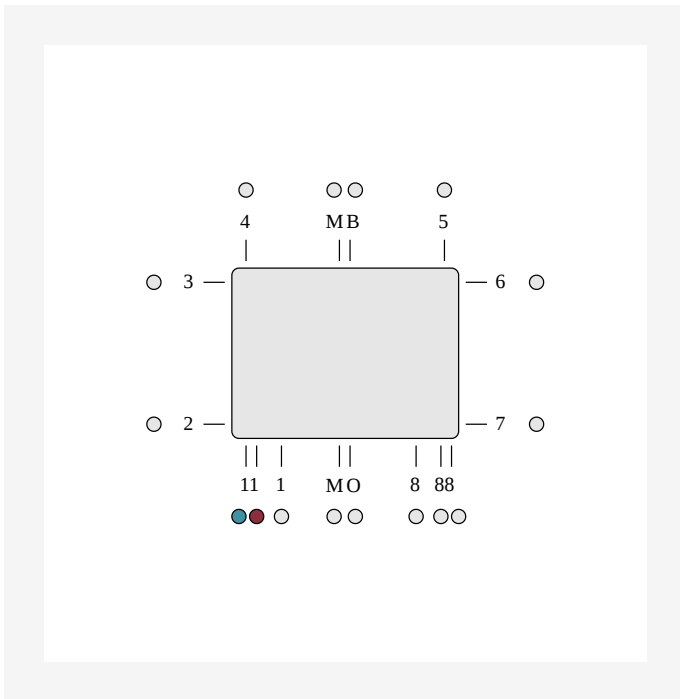

DimensionalDrawing - ETIM 11 Bundtilslutning, ind højre, ud venstre. Bundtilslutning via integreret kapillarrør kræver brug af ventilindsats. Ubrugte tilslutninger er lukkede.



## Relaterede produkter



Ventilindsats M30 Konus

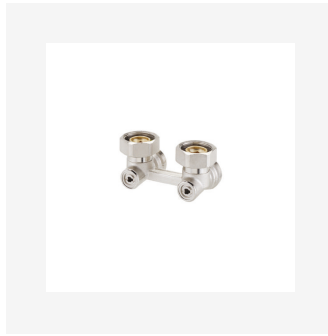

H-stykke med afspærringer  
cc50 G3/42



Toprist Purmo



Udluftningskrue og  
blindprop



Gulvkonsol Purmo Monclac  
Plint



Reparationslak



Purmo sidepanel



Air Vent 1/2"



Udluftningsnøgle



Reparationsmaling spray



Flex Radiatorkobling





## Relaterede produkter



Ventilindsats PRQ



Termostat Evosense



Radiatorventil FV



Termostat Evosense Public



Flamingo



FVRe radiatorventil



Termostat Evosense Remote



## 200

HØJDE 200 mm	LÆNGDE	DYBDE	Varenr./ VVS (V)	Varenr./ VVS (H)	EFFEKT (W) 45/35/20°C	EFFEKT (W) 55/45/20°C	EFFEKT (W) 60/45/20°C	VOLUMEN (l)	N- ekponent	VÆGT (kg)
<b>Type 21</b>										
600	72		FOG2102006011390	FOG2102006011380	96	168	183	0.0	1.32	8.6
700	72		FOG2102007011390	FOG2102007011380	112	196	213	0.0	1.32	10.1
800	72		FOG2102008011380	328723808	128	224	243	2.0	1.32	11.4
900	72		FOG2102009011390	FOG2102009011380	144	252	274	0.0	1.32	12.9
1000	72		FOG2102010011390	FOG2102010011380	160	280	304	0.0	1.32	14.3
1100	72		FOG2102011011390	FOG2102011011380	176	308	335	0.0	1.32	15.8
1200	72		FOG2102012011390	FOG2102012011380	192	337	365	0.0	1.32	17.3
1400	72		FOG2102014011390	FOG2102014011380	224	393	426	0.0	1.32	20.6
1600	72		FOG2102016011390	FOG2102016011380	256	449	487	0.0	1.32	23.3
1800	72		FOG2102018011390	FOG2102018011380	288	505	548	0.0	1.32	25.8
2000	72		FOG2102020011390	FOG2102020011380	319	561	609	0.0	1.32	0.0
2300	72		FOG2102023011390	FOG2102023011380	367	645	700	0.0	1.32	0.0
2600	72		FOG2102026011390	FOG2102026011380	415	729	791	0.0	1.32	0.0
3000	72		FOG2102030011390	FOG2102030011380	479	841	913	0.0	1.32	0.0
<b>Type 22</b>										
600	104		FOG2202006011380	328724806	126,125	221	240	1.5	1.32	9.2
700	104		FOG2202007011390	FOG2202007011380	147	258	280	0.0	1.32	0.0
800	104		FOG2202008011390	FOG2202008011380	167	295	320	0.0	1.32	0.0
900	104		FOG2202009011390	FOG2202009011380	188	331	360	0.0	1.32	0.0
1000	104		FOG2202010011390	FOG2202010011380	209	368	400	0.0	1.32	0.0
1100	104		FOG2202011011390	FOG2202011011380	230	405	439	0.0	1.32	0.0
1200	104		FOG2202012011390	FOG2202012011380	251	442	480	0.0	1.32	0.0
1400	104		FOG2202014011390	FOG2202014011380	293	515	560	0.0	1.32	0.0



## 200

HØJDE 200 mm	LÆNGDE	DYBDE	Varenr./ VVS (V)	Varenr./ VVS(H)	EFFEKT (W) 45/35/20°C	EFFEKT (W) 55/45/20°C	EFFEKT (W) 60/45/20°C	VOLUMEN (l)	N- ekponent	VÆGT (kg)
1600	104		FOG2202016011390	FOG2202016011380	335	589	639	0.0	1.32	0.0
1800	104		FOG2202018011390	FOG2202018011380	377	663	719	0.0	1.32	0.0
2000	104		FOG2202020011390	FOG2202020011380	418	736	799	0.0	1.32	0.0
2300	104		FOG2202023011390	FOG2202023011380	481	847	919	0.0	1.32	0.0
2600	104		FOG2202026011390	FOG2202026011380	544	957	1039	0.0	1.32	0.0
3000	104		FOG2202030011390	FOG2202030011380	628	1105	1199	0.0	1.32	0.0
<b>Type 33</b>										
600	154		FOG3302006011390	FOG3302006011380	180	318	345	0.0	1.33	0.0
700	154		FOG3302007011390	FOG3302007011380	210	371	403	0.0	1.33	0.0
800	154		FOG3302008011390	FOG3302008011380	240	424	460	0.0	1.33	0.0
900	154		FOG3302009011390	FOG3302009011380	270	477	518	0.0	1.33	0.0
1000	154		FOG3302010011390	FOG3302010011380	300	530	575	0.0	1.33	0.0
1100	154		FOG3302011011390	FOG3302011011380	330	583	633	0.0	1.33	0.0
1200	154		FOG3302012011390	FOG3302012011380	360	636	690	0.0	1.33	0.0
1400	154		FOG3302014011390	FOG3302014011380	420	742	806	0.0	1.33	0.0
1600	154		FOG3302016011390	FOG3302016011380	480	848	920	0.0	1.33	0.0
1800	154		FOG3302018011390	FOG3302018011380	540	954	1036	0.0	1.33	0.0
2000	154		FOG3302020011390	FOG3302020011380	600	1059	1151	0.0	1.33	0.0
2300	154		FOG3302023011390	FOG3302023011380	689	1218	1323	0.0	1.33	0.0
2600	154		FOG3302026011390	FOG3302026011380	779	1377	1496	0.0	1.33	0.0
3000	154		FOG3302030011390	FOG3302030011380	899	1589	1726	0.0	1.33	0.0
<b>Type 44</b>										
600	204		FOG4402006011390	FOG4402006011380	228	405	439	0.0	1.34	0.0
700	204		FOG4402007011390	FOG4402007011380	266	472	513	0.0	1.34	0.0
800	204		FOG4402008011390	FOG4402008011380	304	539	586	0.0	1.34	0.0



# 200

HØJDE 200 mm	LÆNGDE	DYBDE	Varenr./ VVS (V)	Varenr./ VVS(H)	EFFEKT (W) 45/35/20°C	EFFEKT (W) 55/45/20°C	EFFEKT (W) 60/45/20°C	VOLUMEN (l)	N- ekponent	VÆGT (kg)
900	204		FOG4402009011390	FOG4402009011380	342	607	659	0.0	1.34	0.0
1000	204		FOG4402010011390	FOG4402010011380	380	674	733	0.0	1.34	0.0
1100	204		FOG4402011011390	FOG4402011011380	418	742	806	0.0	1.34	0.0
1200	204		FOG4402012011390	FOG4402012011380	456	809	879	0.0	1.34	0.0
1400	204		FOG4402014011390	FOG4402014011380	532	944	1026	0.0	1.34	0.0
1600	204		FOG4402016011390	FOG4402016011380	608	1079	1172	0.0	1.34	0.0
1800	204		FOG4402018011390	FOG4402018011380	684	1214	1319	0.0	1.34	0.0
2000	204		FOG4402020011390	FOG4402020011380	760	1348	1465	0.0	1.34	0.0
2300	204		FOG4402023011390	FOG4402023011380	874	1551	1685	0.0	1.34	0.0
2600	204		FOG4402026011390	FOG4402026011380	988	1753	1905	0.0	1.34	0.0
3000	204		FOG4402030011390	FOG4402030011380	1140	2023	2198	0.0	1.34	0.0