



Datablad

2026-06-25

Plan Compact Ventil (FCV)

Plan Ventil Compact panel radiators have a completely flat front.



- ✓ Elegant design
- ✓ Maks. effekt: 60W
- ✓ Høj ydeevne
- ✓ Nemt at montere
- ✓ Fås i flere størrelser

Plan Ventil Compact is a traditional panel radiator with flat front for closed water-borne heating systems. White RAL 9016 finish.



Anvendelsesområde

Plan Ventil Compact er ideel til både nybyggeri og renoveringer, passer perfekt under store vinduer og i moderne miljøer, hvor pladsen er trang. Den er egnet til lukkede vandbaserede varmesystemer og tilbyder forskellige højder og bredder, herunder 200-900 mm og 400-3000 mm. Den understøtter fleksible installationsmuligheder og kan tilsluttes fra siden eller bunden

Dimensionering

Vælg produktet baseret på dine specifikke højde-, bredde- og typemæssige krav. For hjælp brug vores designservice eller tjek vores brochure for en hurtig udvælgelsesguide

Anvendelse

Sørg for, at Plan Ventil Compact installeres af en professionel. Bestem den passende monteringshøjde og forbindelsestype: bund eller side. Kontroller, at den integrerede ventil er korrekt indstillet til enten 2-rørs

eller 1-rørs systemer. Rengør enheden regelmæssigt for at opretholde optimal ydeevne. Brug tilbehør som rengøringsbørster til indersiden og konsulter installationsmanualen for specifikke procedurer vedrørende montering og forbindelsesjusteringer. Juster ventilpositioner efter behov under installationen for at passe til den krævede varmelayout

AMA-tekst

Plan Ventil Compact er en fladpanelradiator egnet til lukkede vandbaserede varmesystemer, der leverer både æstetiske og funktionelle fordele. Fremstillet af høj kvalitet koldvalset stål (EN 10130), gennemgår den en femtrins overfladebehandling inklusive fosfatering og pulverlakering. Den passer til moderne miljøer med en højde på 200–900 mm og længder fra 400–3000 mm. Enheden inkluderer et integreret ventilsystem, der understøtter bund- eller sideforbindelser. Den opfylder EN 442-1 konstruktionsstandarder og fungerer effektivt ved et arbejdstryk på 10 bar med en maksimal temperatur på 110°C. Fås i RAL 9016 og andre farver efter anmodning



Specifikationer

EGENSKABER	ENHED	VÆRDIER
ETIM-klasse		EC011022
Materiale		Stål
Type		11, 21, 22, 33
Overfladestruktur		Flad glat
Maks. arbejdsstryk	bar	10
Antal standardtilslutninger		2
Varmeafgivelse iht. anerkendt EN 442-laboratorium		Ja
Maks. driftstemperatur	°C	110
Standardfarve		Ja
Farve		Hvid
RAL-nummer		9016
Gitter/Dækkplade		Ja
Gitter/Dækkplade		Ja
Glansværdi		Glansfuld
Gængedimension (tomme)		1/2 tomme
Tilslutning gevind		Intern gevind
Med etpunkttilslutning		Ja
Med udluftningstilslutning		Ja
Med udluftningsventil/aflufter		Ja
Med aftapningsmulighed		Ja



Dokumenter

DOKUMENTER	DOKUMENTTYPE	LINK
Taethedstest	Installation	https://asset.productmarketingcloud.com/api/assetstorage/3577_c37363c0-7a55-470a-bf93-031f44c77bbe
Varmeeffekt-beregner (EXCEL), panelradiatorer	TechDia	https://asset.productmarketingcloud.com/api/assetstorage/3577_2da398bb-5820-4a58-af2d-62333aa4e65e



Ressourcer



ProductImage - Panel radiator Plan Ventil Compact, FCV, with flat front.

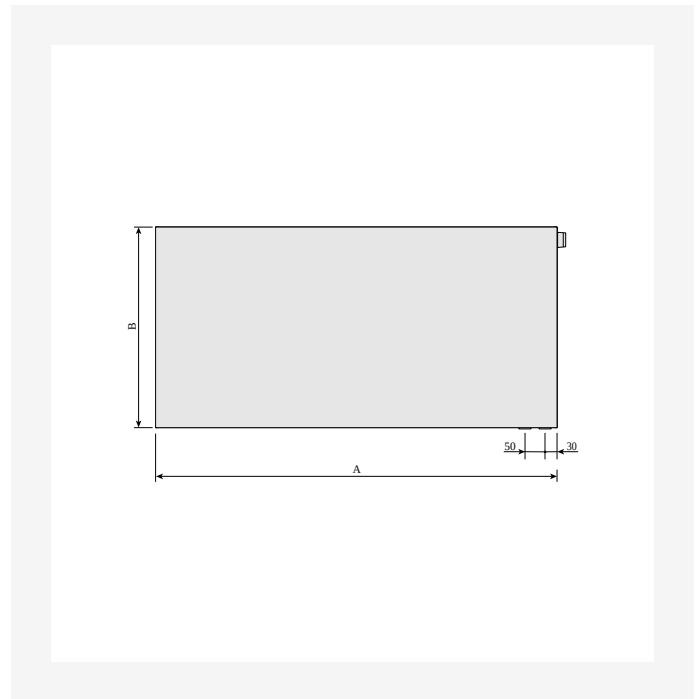

DimensionalDrawing - Plan Ventil Compact, forfra, højre

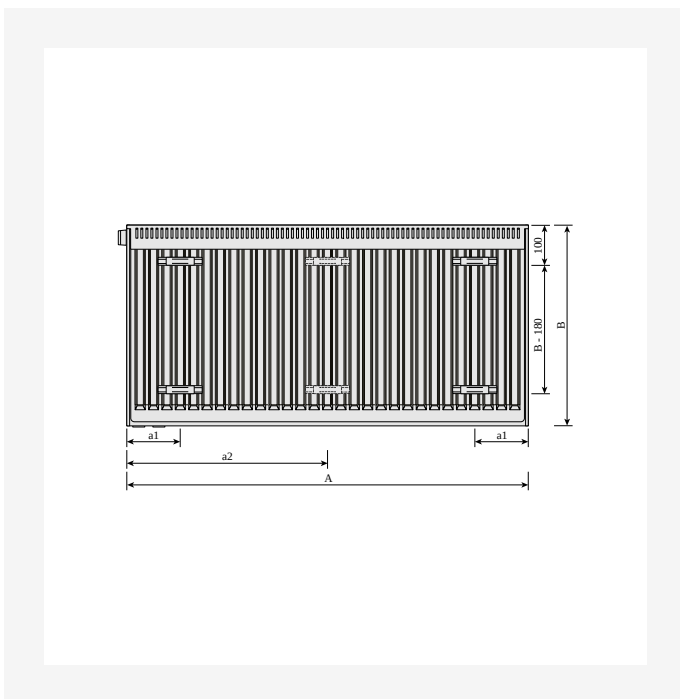

DimensionalDrawing - Plan Ventil Compact, bagfra

PLAN VENTIL COMPACT (mm)		
	FCV11	
A	a1	a2
400-1600	117	-
1800	117	917
2000	117	1017
2300	117	1150
2600	117	1317
3000	117	1517

DimensionalDrawing - Plan Ventil Compact, tabeltegning A



Ressourcer

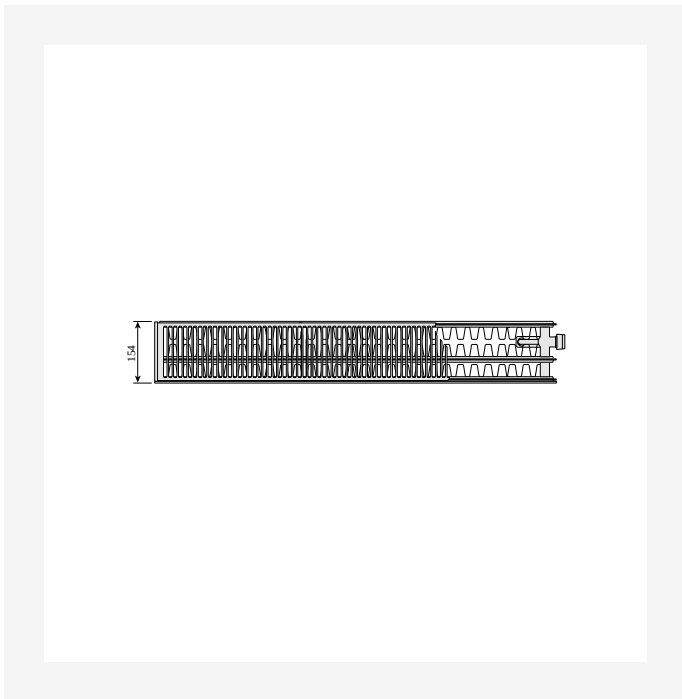

DimensionalDrawing - Plan Ventil Compact og Ramo Ventil Compact, type 33, højre, set oppefra

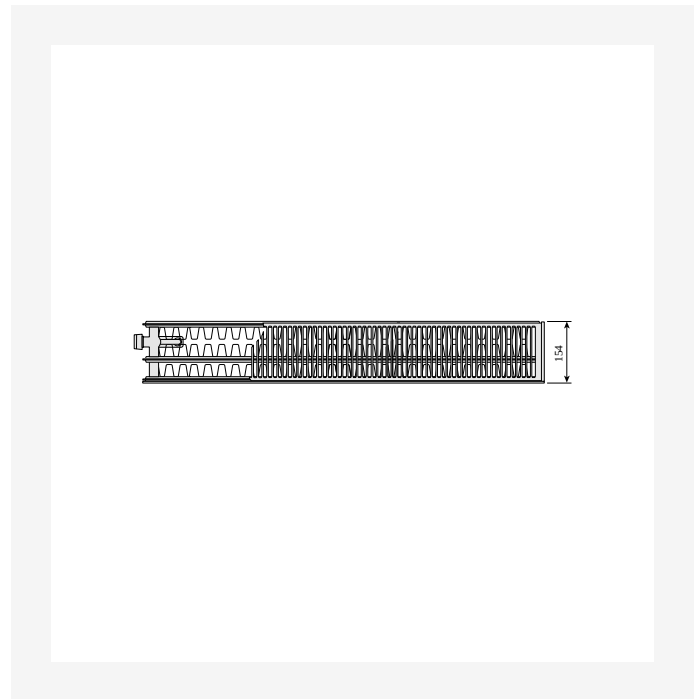

DimensionalDrawing - Plan Ventil Compact og Ramo Ventil Compact, type 33, venstre, set oppefra

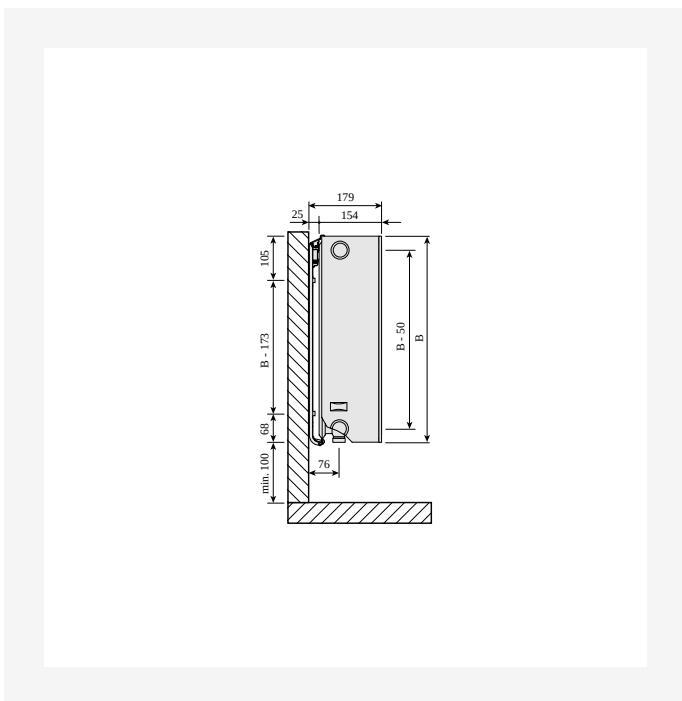

DimensionalDrawing - Plan Ventil Compact og Ramo Ventil Compact, typer 30-33, sidevisning



DimensionalDrawing - Plan Ventil Compact og Ramo Ventil Compact, type 22, højre, set oppefra



Ressourcer



DimensionalDrawing - Plan Ventil Compact og Ramo Ventil Compact, type 22, venstre, set oppefra

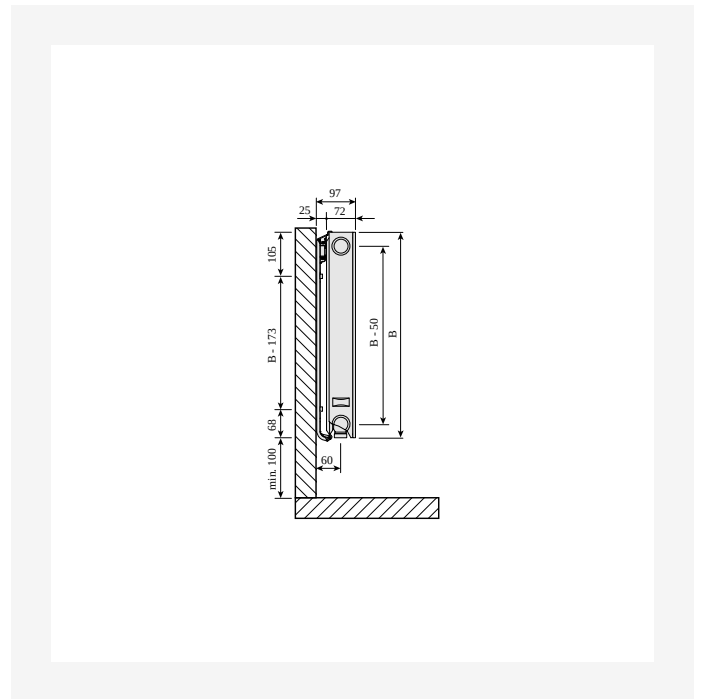

DimensionalDrawing - Plan Ventil Compact og Ramo Ventil Compact, type 21s, sidevisning



DimensionalDrawing - Plan Ventil Compact og Ramo Ventil Compact, type 21s, højre, set oppefra

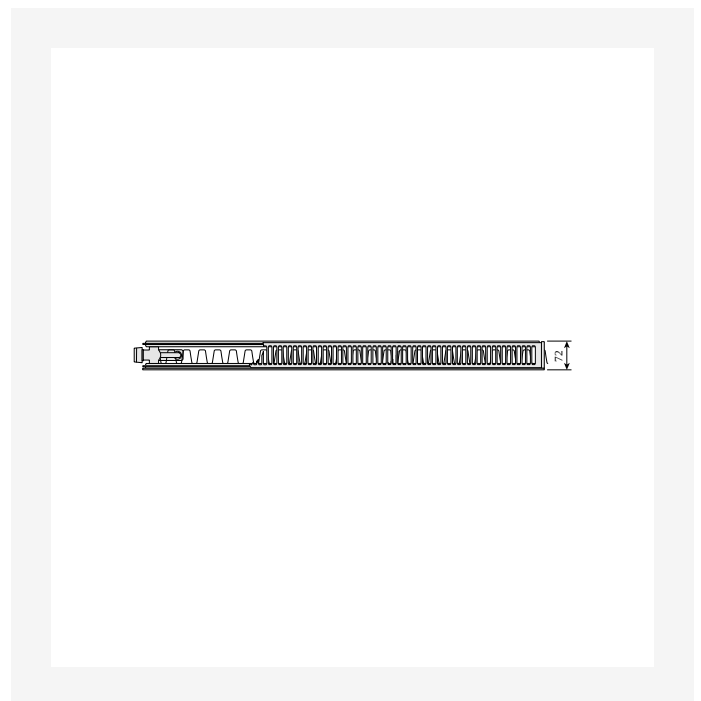

DimensionalDrawing - Plan Ventil Compact og Ramo Ventil Compact, type 21s, venstre, set oppefra



Ressourcer

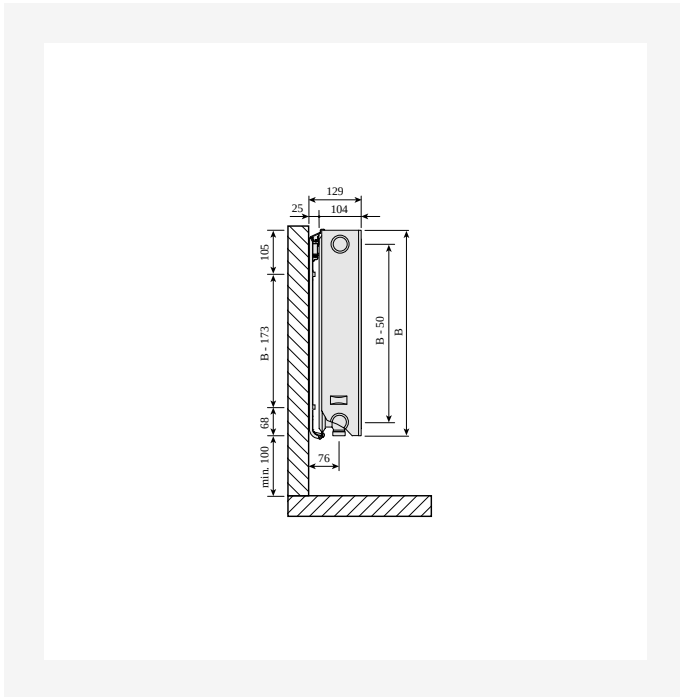

DimensionalDrawing - Plan Ventil Compact og Ramo Ventil Compact, typer 20-22, sidevisning

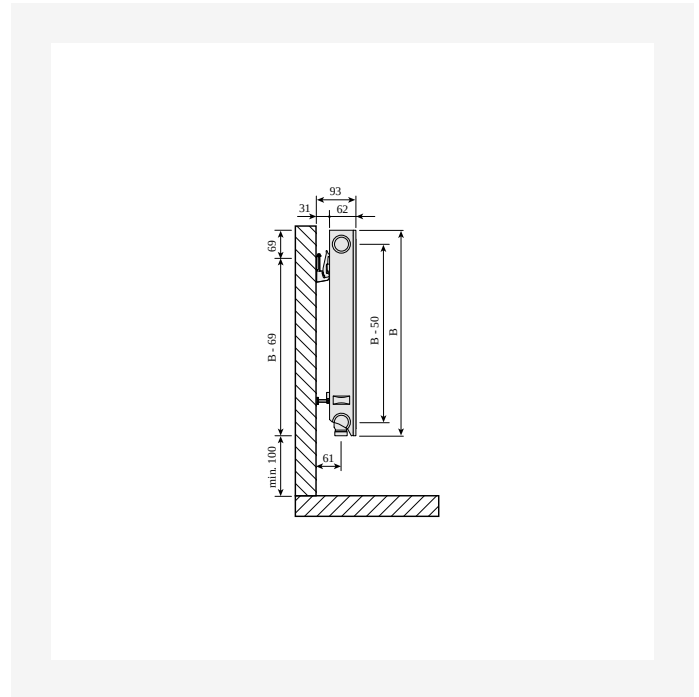

DimensionalDrawing - Plan Ventil Compact og Ramo Ventil Compact, type 11, sidevisning

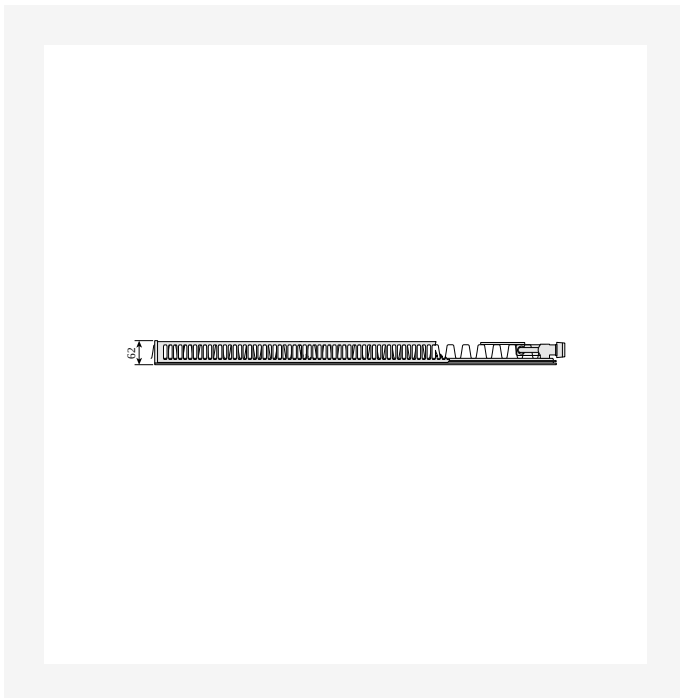

DimensionalDrawing - Plan Ventil Compact og Ramo Ventil Compact, type 11, højre, set oppefra

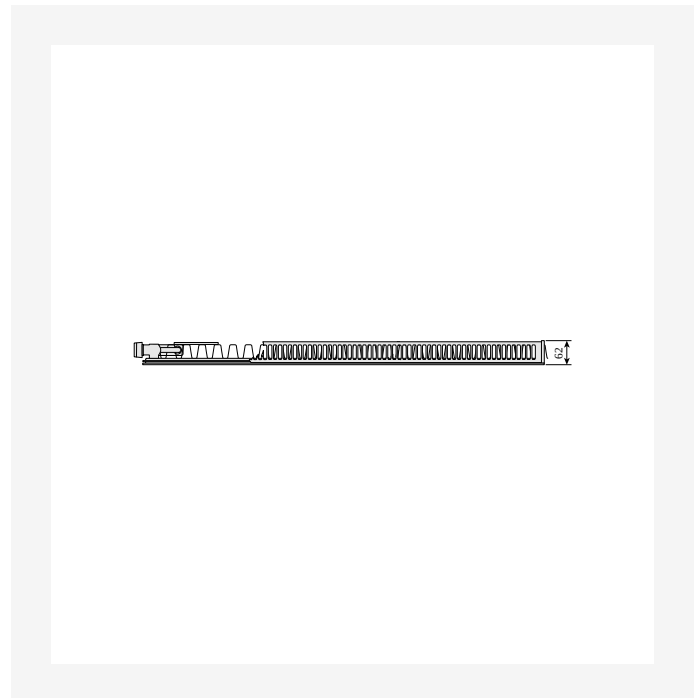

DimensionalDrawing - Plan Ventil Compact og Ramo Ventil Compact, type 11, venstre, set oppefra



Ressourcer

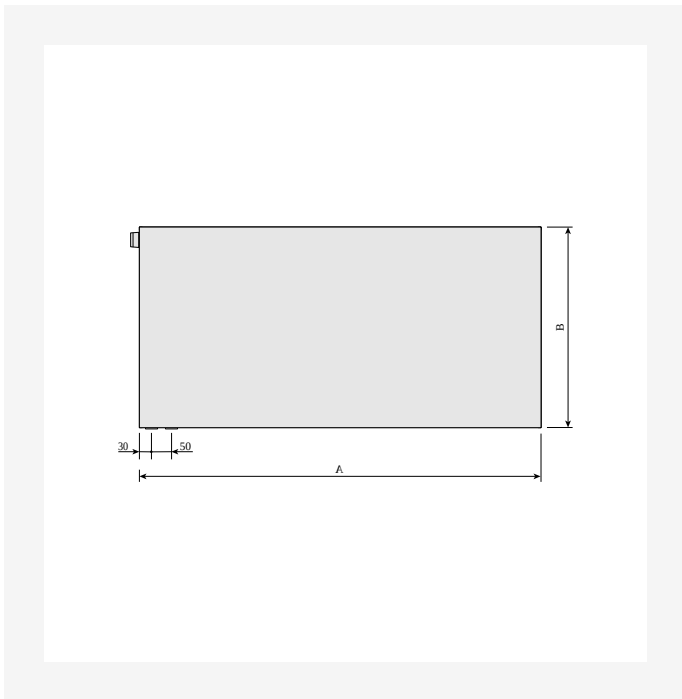

DimensionalDrawing - Plan Ventil Compact, forfra venstre



Relaterede produkter



Toprist Purmo



Purmo sidepanel



300

HØJDE 300 mm	LÆNGDE	DYBDE	Varenr./ VVS	EFFEKT (W) 45/35/20°C	EFFEKT (W) 55/45/20°C	EFFEKT (W) 60/45/20°C	VOLUMEN (l)	N- ekponent	VÆGT (kg)
Type 11									
	400	62	328551104	64	110	119	0.7	1.28	5.6
	600	62	328551166	95	165	178	1.0	1.28	7.7
	700	62	328551167	111	192	208	1.2	1.28	8.8
	1200	62	328551172	191	330	357	2.0	1.28	14.6
	2300	62	328551123	366	632	684	3.9	1.28	25.8
	2600	62	328551126	413	715	773	4.4	1.28	28.9
Type 21									
	400	72	328553164	88	152	165	1.4	1.28	7.6
	500	72	328553105	110	190	206	1.7	1.28	9.2
	1200	72	328553112	265	457	495	4.1	1.28	19.7
	2300	72	328553183	508	876	948	7.8	1.28	36.3
Type 22									
	500	104	328554105	138	241	261	1.7	1.30	1.2
	700	104	328554167	194	338	366	2.4	1.30	13.6
	900	104	328554169	249	434	470	3.1	1.30	16.9
	1200	104	328554112	332	579	627	4.1	1.30	21.9
	2000	104	328554120	554	965	1045	6.8	1.30	35.1
	2300	104	328554123	637	1109	1202	7.8	1.30	4.1
Type 33									
	500	154	328556165	191	335	364	2.5	1.32	14.5
	700	154	328556107	268	470	509	3.6	1.32	18.8
	800	154	328556108	306	537	582	4.1	1.32	21.2
	1000	154	328556110	383	671	728	5.1	1.32	25.9
	2000	154	328556180	765	1342	1455	10.2	1.32	49.6



400

HØJDE 400 mm	LÆNGDE	DYBDE	Varenr./ VVS	EFFEKT (W) 45/35/20°C	EFFEKT (W) 55/45/20°C	EFFEKT (W) 60/45/20°C	VOLUMEN (l)	N- ekponent	VÆGT (kg)
Type 11									
	500	62	328561105	102	177	191	1.1	1.28	8.5
	600	62	328561166	123	212	229	1.3	1.28	10.4
	1000	62	328561110	204	353	382	2.2	1.28	15.7
	1100	62	328561171	225	389	421	2.4	1.28	17.1
Type 21									
	500	72	328563165	139	241	261	2.3	1.28	12.0
	1100	72	328563171	306	530	574	5.0	1.28	24.0
	1600	72	328563116	446	771	835	7.2	1.28	34.0
	2000	72	328563180	557	964	1044	9.0	1.28	42.5
	2600	72	328563186	724	1253	1357	11.7	1.28	54.2
Type 22									
	1100	104	328564171	386	675	732	5.0	1.31	27.0
	3000	104	328564190	1053	1841	1996	13.5	1.31	7.5
Type 33									
	800	154	328566108	385	677	734	5.4	1.32	28.7
	1200	154	328566172	577	1015	1102	8.0	1.32	4.8
	1600	154	328566176	769	1353	1469	10.7	1.32	53.6



500

HØJDE 500 mm	LÆNGDE	DYBDE	Varenr./ VVS	EFFEKT (W) 45/35/20°C	EFFEKT (W) 55/45/20°C	EFFEKT (W) 60/45/20°C	VOLUMEN (l)	N- ekponent	VÆGT (kg)
Type 11									
	800	62	328571108	198	342	370	2.2	1.28	15.8
	900	62	328571169	223	385	416	2.4	1.28	17.6
	1100	62	328571111	272	470	509	3.0	1.28	21.1
	2000	62	328571120	495	855	925	5.4	1.28	37.0
	2600	62	328571186	643	1111	1203	7.0	1.28	47.5
Type 21									
	1100	72	328573111	365	633	686	6.0	1.29	29.7
	1200	72	328573112	398	691	748	6.6	1.29	32.3
	1800	72	328573118	597	1036	1122	9.9	1.29	47.5
Type 22									
	1100	104	328574111	461	809	878	6.0	1.32	33.4
	1600	104	328574176	670	1177	1277	8.8	1.32	47.5
	2000	104	328574180	838	1472	1597	11.0	1.32	58.8
Type 33									
	1400	154	328576174	800	1413	1534	11.5	1.33	59.4



600

HØJDE 600 mm	LÆNGDE	DYBDE	Varenr./ VVS (V)	Varenr./ VVS (H)	EFFEKT (W) 45/35/20°C	EFFEKT (W) 55/45/20°C	EFFEKT (W) 60/45/20°C	VOLUMEN (l)	N- ekponent	VÆGT (kg)
Type 11										
	1000	62	328581110		289	499	540	3.2	128	23.1
	1200	62	328581172		346	599	648	3.8	128	27.4
	1400	62	328581174		404	699	756	4.5	128	31.6
	2600	62	328581186		750	1297	1404	8.3	128	57.2
	3000	62	328581130		866	1497	1620	9.6	128	65.7
Type 21										
	400	72	328583104		153	266	288	2.6	130	14.4
	600	72	328583106		229	398	432	4.0	130	2.5
	1100	72	328583111		420	731	791	7.3	130	35.8
	1200	72	328583172		458	797	863	7.9	130	38.8
	2000	72	328583180	328583120	764	1328	1439	13.2	130	63.2
	3000	72	328583190		1146	1992	2158	19.8	130	93.7
Type 22										
	400	104	328584164		193	340	369	2.6	133	16.4
	600	104	328584106		289	510	553	4.0	133	23.3
	1000	104	328584110		482	850	922	6.6	133	37.1
	1800	104	328584178		867	1530	1660	11.9	133	64.7
	2000	104	328584180		964	1700	1845	13.2	133	71.7
Type 33										
	400	154	328586104		263	465	506	3.9	134	22.5
	800	154	328586108		525	931	1011	7.8	134	42.0
	900	154	328586169		591	1047	1138	8.8	134	46.8
	1800	154	328586118		1181	2094	2275	17.6	134	9.7
	2000	154	328586120		1313	2327	2528	19.6	134	14



900

HØJDE 900 mm	LÆNGDE	DYBDE	Varenr./ VVS	EFFEKT (W) 45/35/20°C	EFFEKT (W) 55/45/20°C	EFFEKT (W) 60/45/20°C	VOLUMEN (l)	N- ekponent	VÆGT (kg)
Type 11									
	1600	62	328591116	636	1109	1201	7.2	1.30	53.8
	1800	62	328591118	716	1247	1352	8.1	1.30	6.2
	2000	62	328591120	795	1386	1502	9.0	1.30	66.7
Type 21									
	600	72	328593166	302	535	581	5.4	1.34	3.2
	1100	72	328593111	554	981	1065	9.9	1.34	53.4
	1200	72	328593112	605	1070	1162	10.8	1.34	58.4
	1800	72	328593118	907	1605	1743	16.2	1.34	85.9
Type 33									
	700	154	328596107	620	1107	1204	9.3	1.36	55.2
	900	154	328596109	797	1424	1549	12.0	1.36	69.9
	1200	154	328596172	1062	1898	2065	16.0	1.36	92.6
	2000	154	328596120	1770	3164	3441	26.6	1.36	151.3