



Datablad

2026-06-22

Hygiene (H)

Hygiene is a panel radiator designed for easy cleaning and hygiene.



- ✓ Nem at rengøre
- ✓ Høj holdbarhed
- ✓ Hygiejnisk design
- ✓ Ingen topriste eller sidepaneler

Purmo Hygiene panelradiatorer er ekspertfremstillet til at opfylde de strenge hygiejnestandarder, der kræves i medicinske og laboratoriemiljøer. Fraværet af konvektionslameller samt top- og sideafdækninger, kombineret med en glat, ikke-porøs epoxyharpiks-pulverbelægning, sikrer nem rengøring og desinfektion. Disse radiatorer leverer pålidelig ydeevne med en maksimal driftstemperatur på 110°C og et arbejdsstryk på op til 10 bar. Designet til alsidighed er de kompatible med forskellige hygiejniske miljøer, hvilket gør dem til et førsteklases valg for sundhed og sikkerhed.



Anvendelsesområde

Designet til miljøer med høje krav til renlighed såsom hospitaler, klinikker, plejehjem, laboratorier og andre rum med strenge hygiejnekrav. Funktioner inkluderer koldvalset stålkonstruktion, elektrostatisk pulverbekæmpelse, trykhåndtering op til 10 bar og høj temperaturbestandighed

Dimensionering

For passende valg, overvej rumtype og hygiejnekrav. For at forenkle processen, brug vores designservice eller produktbrochure

Anvendelse

Installer Purmo Hygiene panelradiatorer og sørg for en afstand til rengøring og luftstrøm. Tilslut ved hjælp af fire G 1/2" sideforbindelser. Rengør regelmæssigt med godkendte desinfektionsmidler. Installationer skal følge

alle relevante sundheds- og sikkerhedsretningslinjer. Sørg for, at radiatorerne er fastgjort sikkert ved hjælp af de anbefalede beslag til den specifikke model og installationsmiljø.

AMA-tekst

Purmo Hygiene panelradiatoren er en høj kvalitets varmeløsning optimeret til miljøer med strenge hygiejnekrav. Fremstillet af premium koldvalset stål og med en epoxyharpiks-pulverbelægning, opfylder denne radiator EN 442-1 standarder og kan modstå op til 10 bar tryk og temperaturer op til 110°C. Fraværet af konvektionslameller, topgrill og sidepaneler forenkler rengøring og minimerer støvophobning. Den fås i forskellige størrelser og versioner (Type H 10, H 20, H 30) med fleksible monteringsbeslag og tilslutningsmuligheder. Radiatorens glatte, ikke-porøse overflade er designet til nem desinfektion, hvilket gør den ideel til brug i hospitaler, klinikker, plejehjem og laboratorier



Specifikationer

EGENSKABER	ENHED	VÆRDIER
ETIM-klasse		EC011022
Materiale		Stål
Type		10, 20, 30
Overfladestruktur		Profileret
Maks. arbejdsstryk	bar	10
Antal standardtilslutninger		4
Varmeafgivelse iht. anerkendt EN 442-laboratorium		Ja
Maks. driftstemperatur	°C	110
Standardfarve		Ja
Farve		Hvid
RAL-nummer		9016
Gitter/Dækkplade		Ja
Gitter/Dækkplade		Ja
Glansværdi		Glansfuld
Gængedimension (tomme)		1/2 tomme
Tilslutning gevind		Intern gevind
Med etpunkttilslutning		Ja
Med udluftningstilslutning		Ja
Med udluftningsventil/aflufter		Ja
Med aftapningsmulighed		Ja



Dokumenter

DOKUMENTER	DOKUMENTTYPE	LINK
Taethedstest	Installation	https://asset.productmarketingcloud.com/api/assetstorage/3577_c37363c0-7a55-470a-bf93-031f44c77bbe
Varmeeffekt-beregner (EXCEL), panelradiatorer	TechDia	https://asset.productmarketingcloud.com/api/assetstorage/3577_2da398bb-5820-4a58-af2d-62333aa4e65e



Ressourcer



ProductImage - Panel radiator Purmo Hygiene, H.

ProductImage - Compact Hygiene

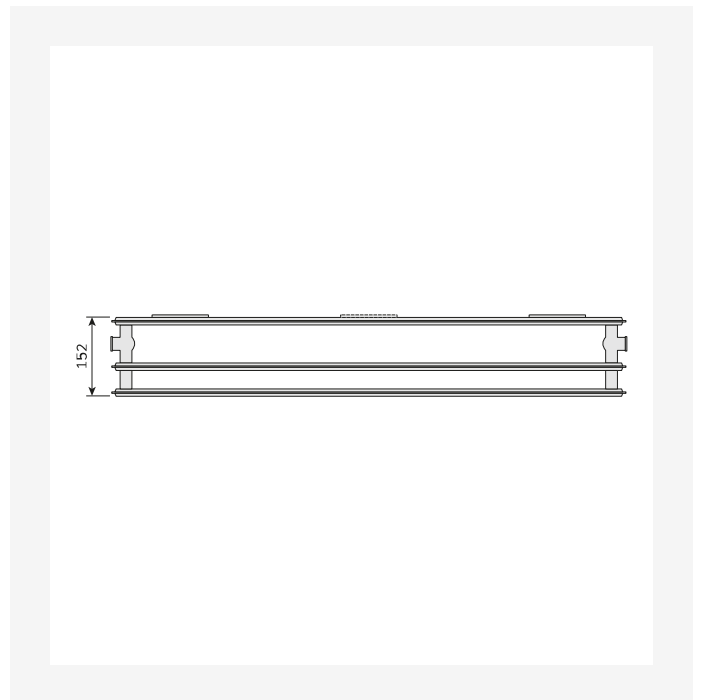

DimensionalDrawing - Hygiene, type 10, bagfra

DimensionalDrawing - Hygiene, type 30, set oppefra



Ressourcer

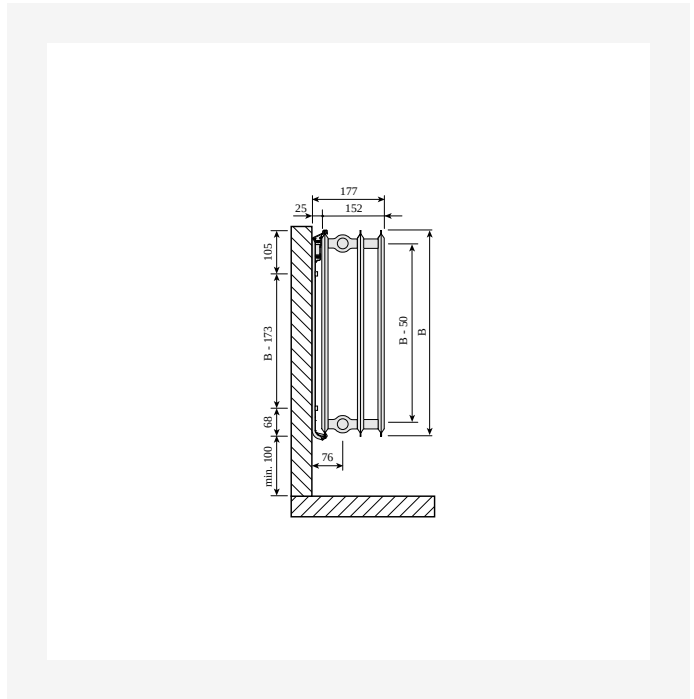
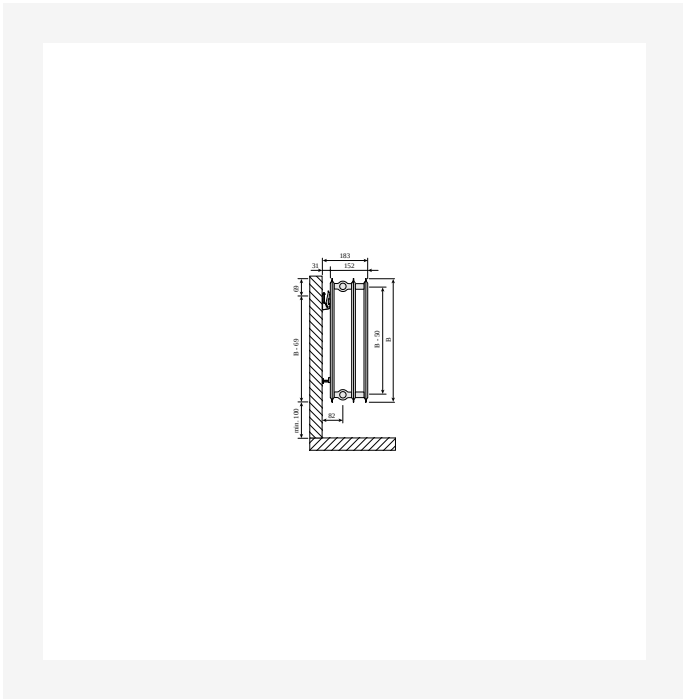

DimensionalDrawing - Drawing PR Hygiene T30 SV SSMS

DimensionalDrawing - Hygiene, type 30, sidevisning med Monclac vægbeslag

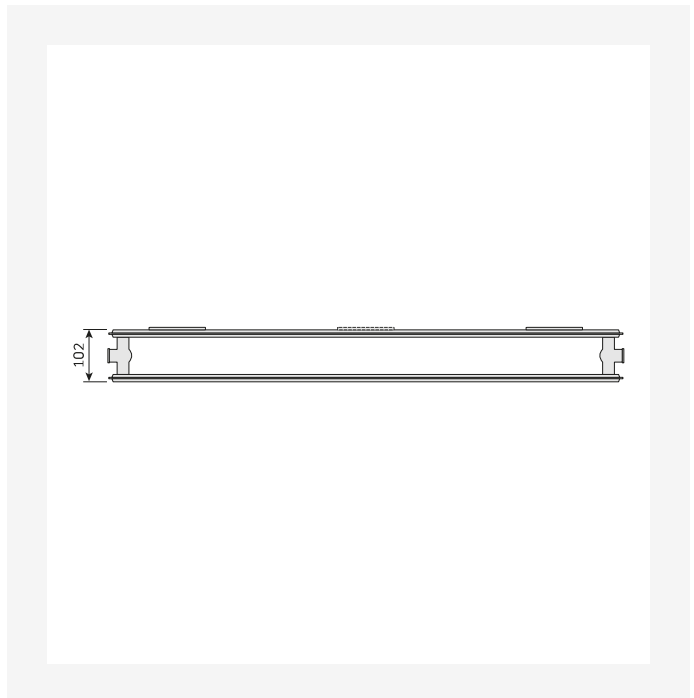
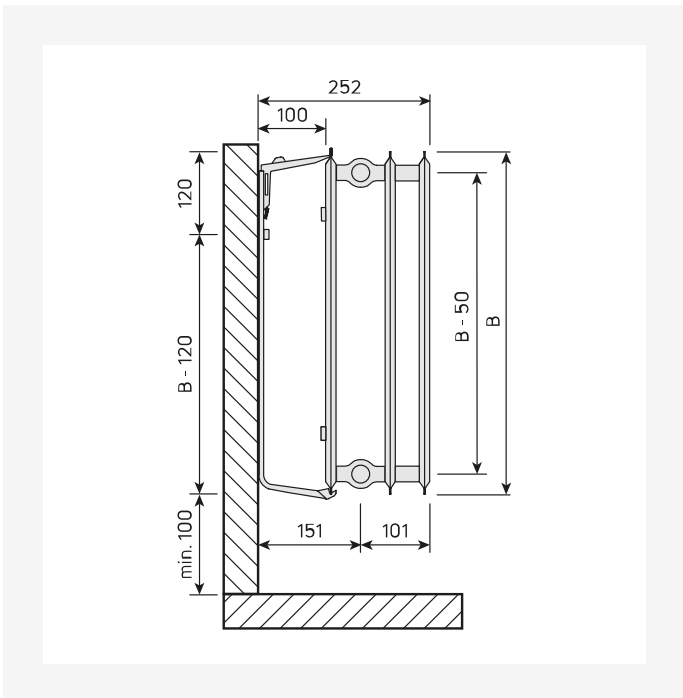

DimensionalDrawing - Hygiene, type 30, sidevisning

DimensionalDrawing - Hygiene, type 20, set oppefra



Ressourcer

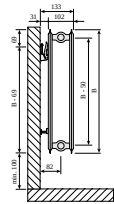

DimensionalDrawing - Drawing PR Hygiene T20 SV SSMS

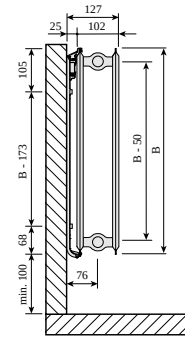

DimensionalDrawing - Hygiene, type 20, sidevisning med Monclac vægbeslag

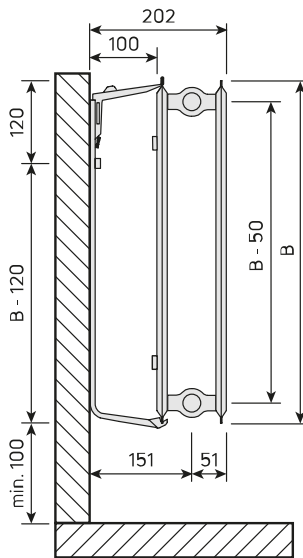

DimensionalDrawing - Hygiene, type 20, sidevisning



DimensionalDrawing - Hygiene, type 10, set oppefra



Ressourcer

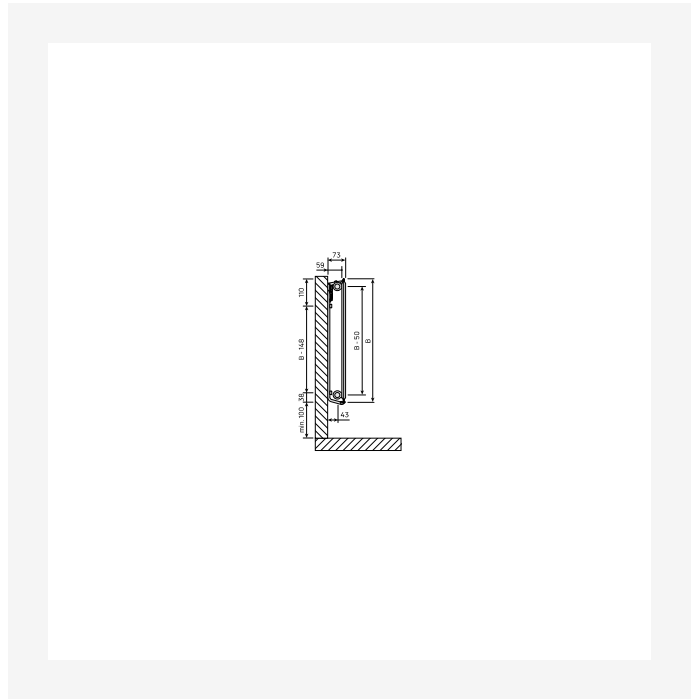
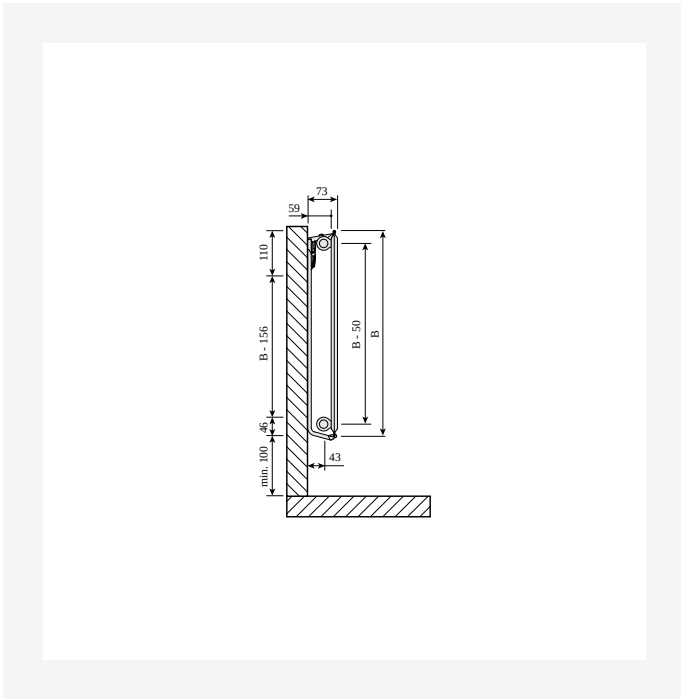

DimensionalDrawing - Hygiene, type 10, sidevisning med Monclac vægbeslag

DimensionalDrawing - Hygiene, type 10, sidevisning, MCK

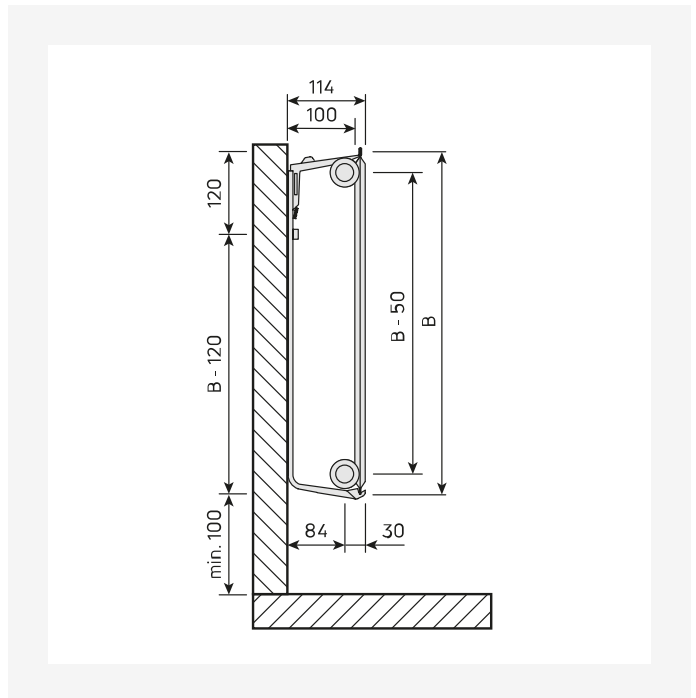
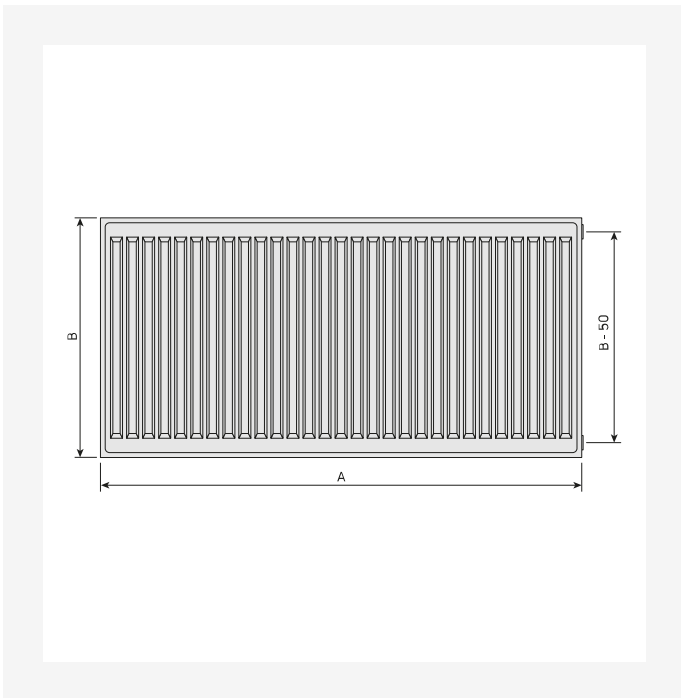

DimensionalDrawing - Hygiene, forfra

DimensionalDrawing - Hygiene, type 10, sidevisning



Ressourcer

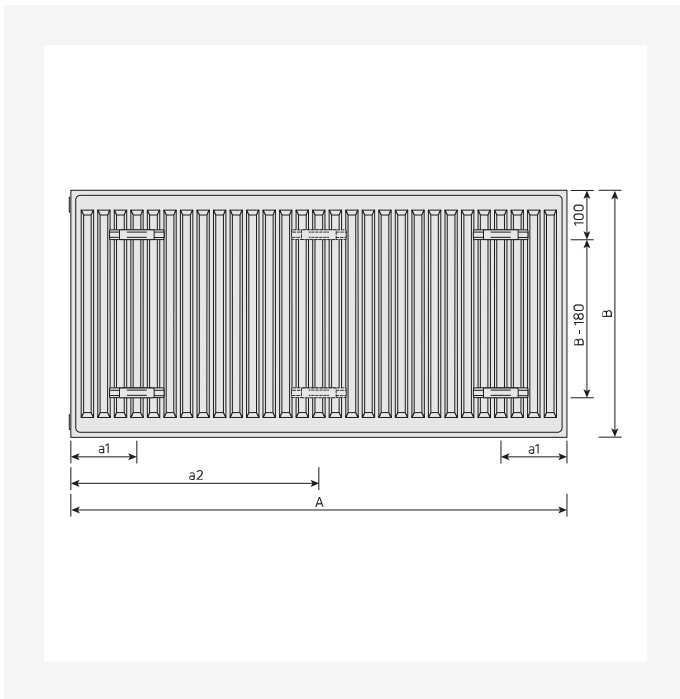

DimensionalDrawing - Hygiene, bagfra

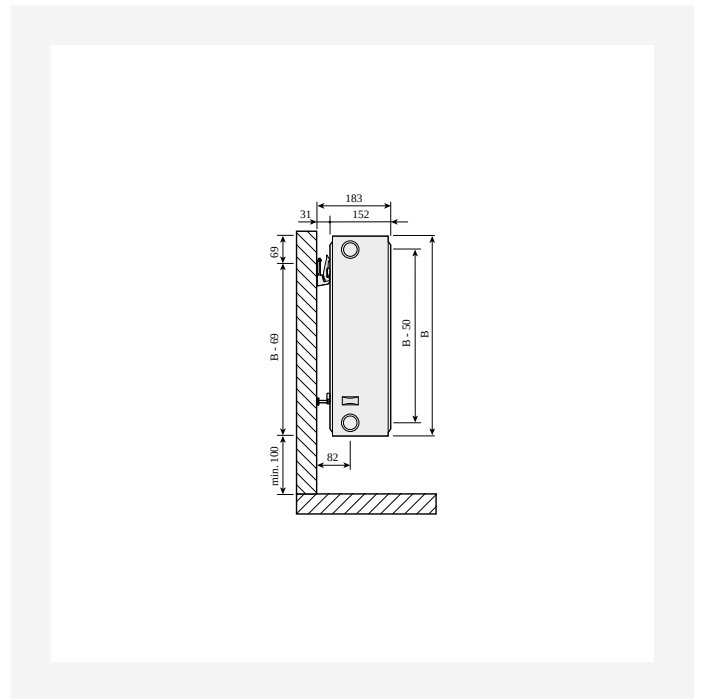

DimensionalDrawing - Compact type 33, sidevisning med SSMS vægbeslag



DimensionalDrawing - Hygiene Plan Compact type 30, set oppefra

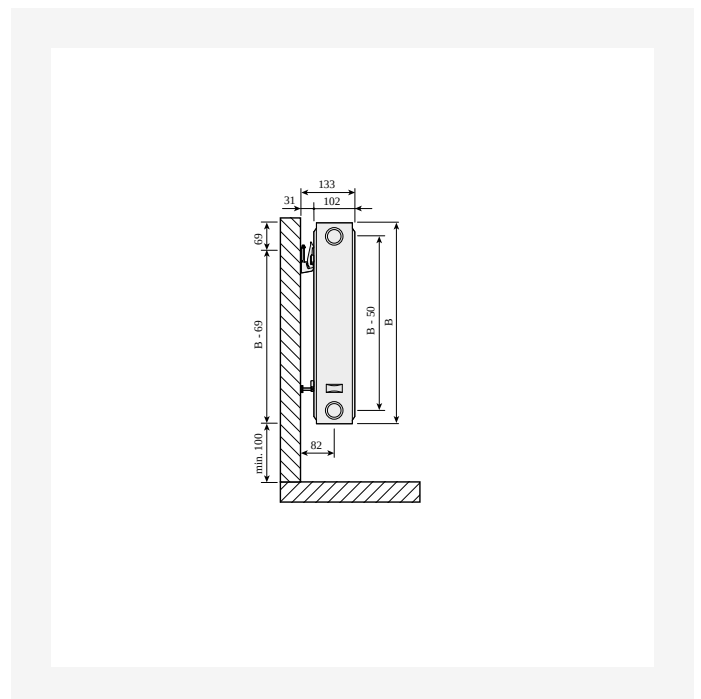

DimensionalDrawing - Compact type 22, sidevisning med SSMS vægbeslag



Ressourcer

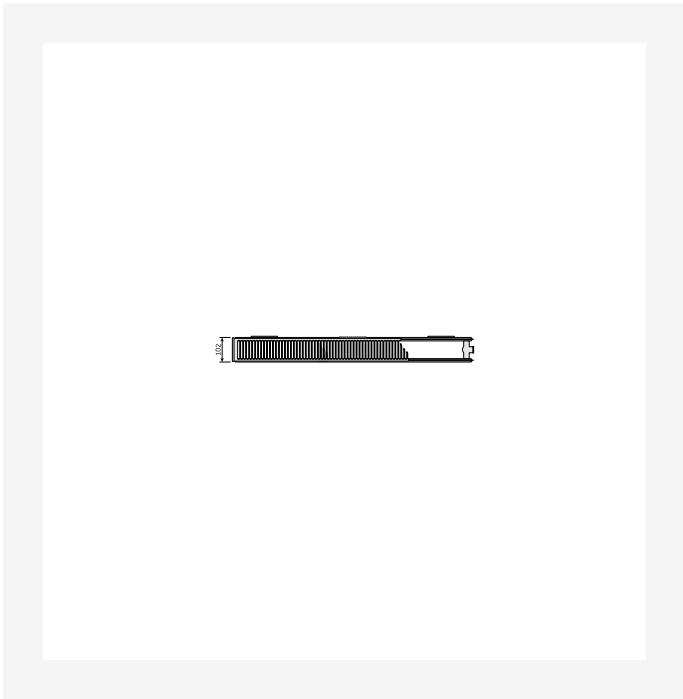

DimensionalDrawing - Hygiene Compact type 20, set oppefra



Relaterede produkter



Udluftningskrue og blindprop



Reparationslak



Air Vent 1/2"



Vægbeslag Monclac



Udluftningsnøgle



Monclac konsoltop 20/30



Holdebøjle



Termostat Evosense Public

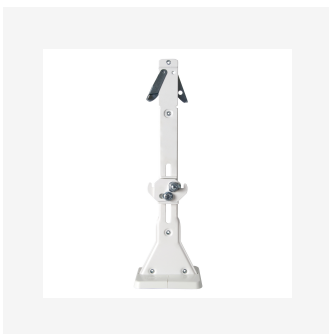

Gulvkonsol Purmo Monclac



300

HØJDE 300 mm	LÆNGDE	DYBDE	Varenr./ VVS	EFFEKT (W) 45/35/20°C	EFFEKT (W) 55/45/20°C	EFFEKT (W) 60/45/20°C	VOLUMEN (l)	N- ekponent	VÆGT (kg)
Type 10	1400	47	328630114	138	245	267	2.4	1.34	8.3



400

HØJDE 400 mm	LÆNGDE	DYBDE	Varenr./ VVS	EFFEKT (W) 45/35/20°C	EFFEKT (W) 55/45/20°C	EFFEKT (W) 60/45/20°C	VOLUMEN (l)	N- ekponent	VÆGT (kg)
Type 10									
	1600	47	328640116	207	365	396	3.5	1.33	12.0
Type 20									
	800	102	328640208	189	327	354	3.6	1.28	11.6



450

HØJDE 450 mm	LÆNGDE	DYBDE	Varenr./ VVS	EFFEKT (W) 45/35/20°C	EFFEKT (W) 55/45/20°C	EFFEKT (W) 60/45/20°C	VOLUMEN (l)	N- ekponent	VÆGT (kg)
Type 30									
	500	152	F063004505000300	178	310	336	3.8	130	12.4
	700	152	F063004507000300	249	434	470	5.3	130	17.4



500

HØJDE 500 mm	LÆNGDE	DYBDE	Varenr./ VVS	EFFEKT (W) 45/35/20°C	EFFEKT (W) 55/45/20°C	EFFEKT (W) 60/45/20°C	VOLUMEN (l)	N- ekponent	VÆGT (kg)
Type 10									
	900	47	328650109	144	252	273	2.4	1.31	8.6
Type 20									
	400	102	328650204	112	195	211	2.2	1.29	7.4
	1200	102	328650212	337	584	632	6.6	1.29	21.5
	2600	102	328650226	731	1265	1369	14.3	1.29	45.0
Type 30									
	2600	152	328650326	1001	1747	1894	21.3	1.31	66.2



550

HØJDE 550 mm	LÆNGDE	DYBDE	Varenr./ VVS	EFFEKT (W) 45/35/20°C	EFFEKT (W) 55/45/20°C	EFFEKT (W) 60/45/20°C	VOLUMEN (l)	N- ekponent	VÆGT (kg)
Type 10									
	900	47	F061005509001300	158	275	298	2.7	130	9.6
	2600	47	F061005526001300	456	794	860	7.8	130	26.2
Type 20									
	700	102	F062005507000300	212	367	397	4.3	129	14.3
	1400	102	F062005514000300	424	734	795	8.5	129	28.6
Type 30									
	2300	152	F063005523000300	952	1663	1803	20.7	131	66.3



600

HØJDE 600 mm	LÆNGDE	DYBDE	Varenr./ VVS	EFFEKT (W) 45/35/20°C	EFFEKT (W) 55/45/20°C	EFFEKT (W) 60/45/20°C	VOLUMEN (l)	N- ekponent	VÆGT (kg)
Type 10									
	1600	47	328660116	304	529	572	5.1	1.29	17.9
	3000	47	328660130	571	991	1073	9.6	1.29	32.7
Type 20									
	600	102	328660206	195	337	365	4.0	1.29	13.4



900

HØJDE 900 mm	LÆNGDE	DYBDE	Varenr./ VVS	EFFEKT (W) 45/35/20°C	EFFEKT (W) 55/45/20°C	EFFEKT (W) 60/45/20°C	VOLUMEN (l)	N- ekponent	VÆGT (kg)
Type 10									
	500	47	328690105	134	233	252	2.3	1.30	8.4
Type 20									
	1200	102	328690212	536	934	1013	10.8	1.30	37.3
	2600	102	328690226	1161	2025	2194	23.4	1.30	8.8
Type 30									
	1100	152	328690311	647	1147	1246	14.6	1.34	48.7