



Datablad

2026-07-02

Compact Ventil Flex (CVF)

Flex er en profileret panelradiator med midtertilslutning i bunden



- ✓ Valgfri termostatplacering
- ✓ Maksimal fleksibilitet
- ✓ Centertilslutning c/c 50 Indvendig 1/2" gevind
- ✓ Neutralt design, passer ind i ethvert interiør
- ✓

Universal og fleksibel panelradiator midtertilslutning nedefra med indbygget Flamingo (FLA), M28 ventilindsats.



Anvendelsesområde

Flexvarmere er ideelle til boliger og erhvervsbygninger. De er velegnede til rum med varierende varmebehov på grund af deres højtrykscapacitet (op til 10 bar) og tilpasningsevne med centralvarmesystemer. Vigtige områder inkluderer stuer, kontorer, butikker og uddannelsesinstitutioner.

Dimensionering

Udvælgelseskriterier inkluderer ønsket output, dimensioner og monteringspræferencer. For detaljeret vejledning henvises til vores designservice eller brug vores omfattende brochure.

Anvendelse

For at installere Flex-radiatorer skal du sikre, at den centrale bundforbindelse anvendes. Monter radiatoren ved hjælp af de medfølgende vægbeslag og tilslut rørbøjningen med 1/2" fittings. Sørg for, at systemet

testes for maksimalt driftstryk på 10 bar. Juster termostathovedet, som kan monteres på begge sider, for at opretholde optimal rumtemperatur. Kontroller, at alle forbindelser er sikre, og udluft radiatoren for at fjerne eventuel fanget luft før brug.

AMA-tekst

Purmo Flex radiatorer har høj kvalitet, dybt præget lavkulfstål, der sikrer holdbarhed og enestående ydeevne. De har en central bundtilslutning på 1/2", er trykprøvet op til 13 bar og kan tåle et driftstryk på 10 bar med en maksimal temperatur på 110°C. Flex radiatorer fås i forskellige profiler, dimensioner og farver, hvilket gør dem velegnede til forskellige anvendelser. Disse radiatorer tilbyder den unikke fordel ved frit valgbare ventilpositioner på begge sider, hvilket øger installationsfleksibiliteten. Pakken inkluderer vægbeslag, en luftventil og ventilindsatser. Bemærk at termostatisk hoved og tilslutningssæt skal bestilles separat.



Specifikationer

EGENSKABER	ENHED	VÆRDIER
ETIM-klasse		EC011022
Materiale		Stål
Type		11, 21, 22, 33
Overfladestruktur		Profileret
Maks. arbejdsstryk	bar	10
Antal standardtilslutninger		2
Varmeafgivelse iht. anerkendt EN 442-laboratorium		Ja
Maks. driftstemperatur	°C	110
Standardfarve		Ja
Farve		Hvid
RAL-nummer		9016
Gitter/Dækkplade		Ja
Gitter/Dækkplade		Ja
Glansværdi		Glansfuld
Gængedimension (tomme)		1/2 tomme
Tilslutning gevind		Intern gevind
Med etpunkttilslutning		Ja
Med udluftningstilslutning		Ja
Med udluftningsventil/aflufter		Ja
Med aftapningsmulighed		Ja



Dokumenter

DOKUMENTER	DOKUMENTTYPE	LINK
Taethedstest	Installation	https://asset.productmarketingcloud.com/api/assetstorage/3577_c37363c0-7a55-470a-bf93-031f44c77bbe



Ressourcer



ProductImage - P-Flex-2000x2000px

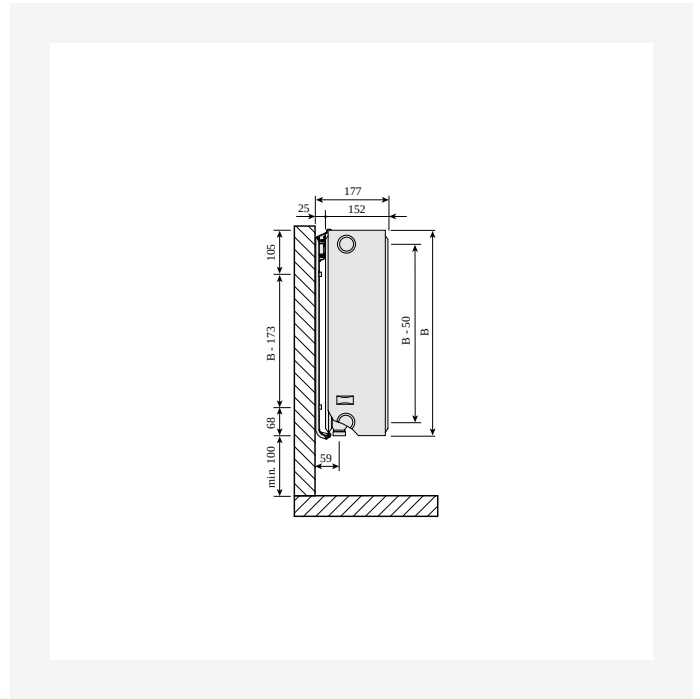

DimensionalDrawing - Compact Ventil Flex, type 33, sidevisning

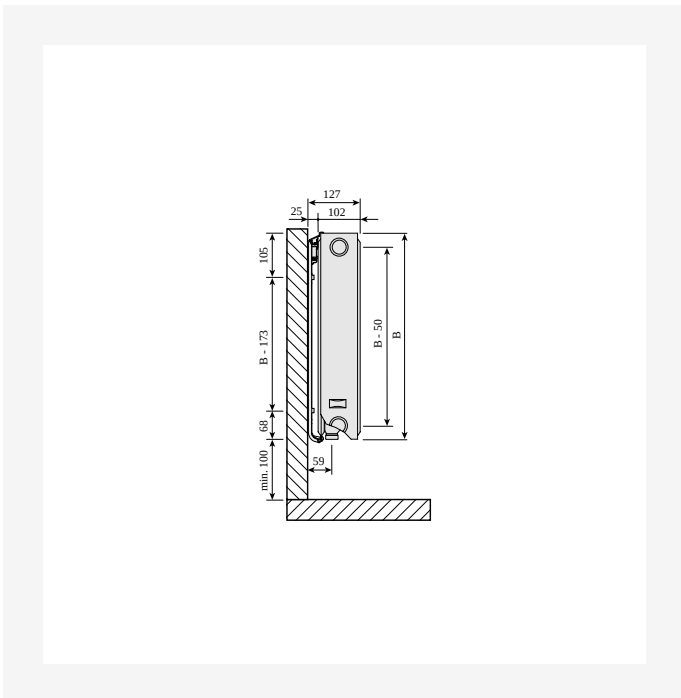

DimensionalDrawing - Compact Ventil Flex, type 22, sidevisning

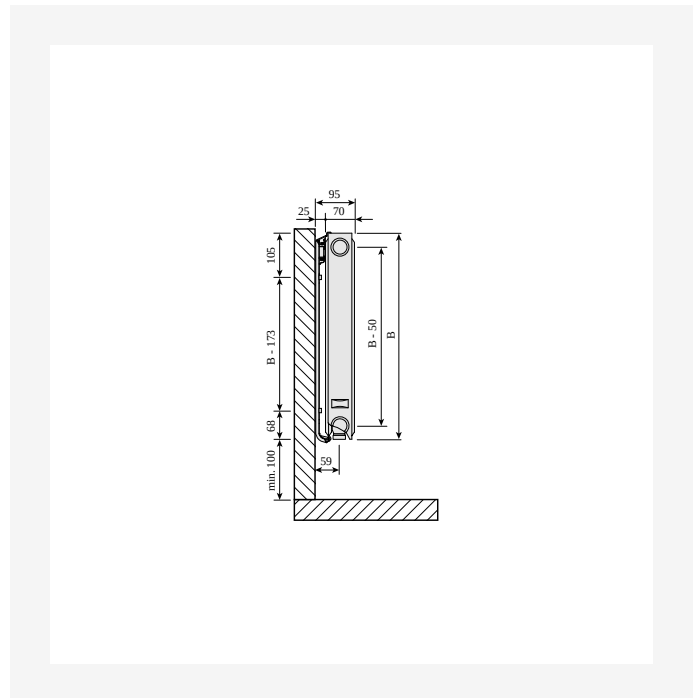

DimensionalDrawing - Compact Ventil Flex, type 21, sidevisning



Ressourcer

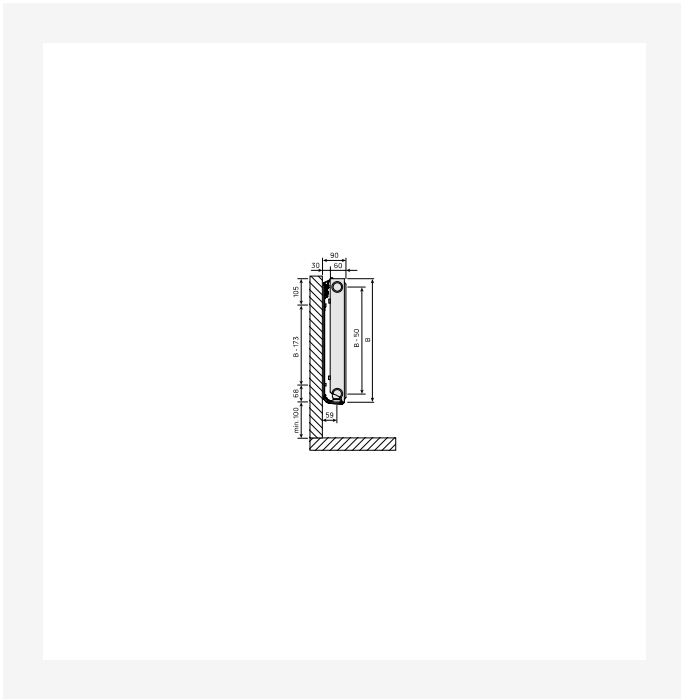

DimensionalDrawing - PR-Flex-T11-SV-Monclack-1122



DimensionalDrawing - Flex, type 11, set oppefra



DimensionalDrawing - Flex, type 21, set oppefra

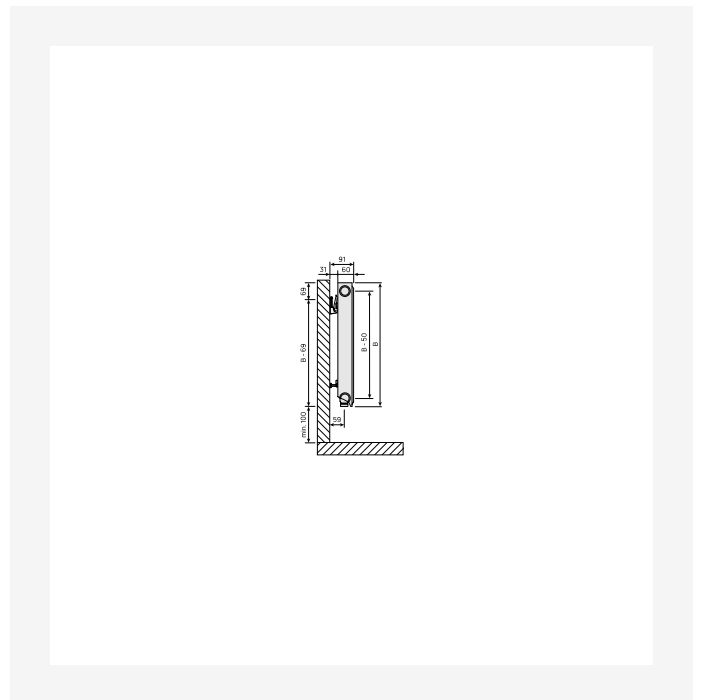

DimensionalDrawing - Flex, type 11, sidevisning



Relaterede produkter



Ventilindsats M30 Konus



Toprist Purmo



Udluftningsskrue og blindprop



Reparationslak



Purmo sidepanel



Air Vent 1/2"



Krydskobling CC50



Single Pipe Manifold



Vægbeslag Monclac



Monoblocco



Udluftningsnøgle



Ventilindsats PRQ



Relaterede produkter



Termostat Evosense



H-blokvinkel G3/4



Termostat Evosense Public



Flex air vent 1/2



Flamingo



300

HØJDE 300 mm	LÆNGDE	DYBDE	Varenr./ VVS	EFFEKT (W) 45/35/20°C	EFFEKT (W) 55/45/20°C	EFFEKT (W) 60/45/20°C	VOLUMEN (l)	N- ekponent	VÆGT (kg)
Type 11									
400	60	328501404	65	113	122	0.7	1.30	4.6	
500	60	328501405	81	141	152	0.8	1.30	5.5	
600	60	328501406	97	169	183	1.0	1.30	6.3	
700	60	328501407	113	197	213	1.2	1.30	7.1	
800	60	328501408	129	225	244	1.4	1.30	8.0	
900	60	328501409	145	253	274	1.5	1.30	8.8	
1000	60	328501410	162	281	305	1.7	1.30	9.6	
1100	60	328501411	178	309	336	1.9	1.30	14	
1200	60	328501412	194	338	366	2.0	1.30	11.3	
1400	60	328501414	226	394	427	2.4	1.30	12.9	
1600	60	328501416	259	450	488	2.7	1.30	14.5	
1800	60	328501418	291	506	549	3.1	1.30	16.4	
2000	60	328501420	323	563	610	3.4	1.30	18.1	
2300	60	328501423	372	647	701	3.9	1.30	2.5	
2600	60	328501426	420	731	793	4.4	1.30	23.0	
3000	60	328501430	485	844	915,914	5.1	1.30	26.1	
Type 21									
400	70	328503404	92	158	171	1.4	1.28	6.8	
500	70	328503405	115	198	214	1.7	1.28	8.0	
600	70	328503406	138	237	257	2.0	1.28	9.3	
700	70	328503407	160	277	300	2.4	1.28	1.6	
800	70	328503408	183	317	343	2.7	1.28	11.8	
900	70	328503409	206	356	386	3.1	1.28	13.1	
1000	70	328503410	229	396	428	3.4	1.28	14.3	



300

HØJDE 300 mm	LÆNGDE	DYBDE	Varenr./ VVS	EFFEKT (W) 45/35/20°C	EFFEKT (W) 55/45/20°C	EFFEKT (W) 60/45/20°C	VOLUMEN (l)	N- ekponent	VÆGT (kg)
	1100	70	328503411	252	435	471	3.7	1.28	15.5
	1200	70	328503412	275	475	514	4.1	1.28	16.8
	1400	70	328503414	321	554	599	4.8	1.28	19.3
	1600	70	328503416	367	633	686	5.4	1.28	21.7
	1800	70	328503418	412	712	771	6.1	1.28	24.4
	2000	70	328503420	458	791	857	6.8	1.28	28.0
	2300	70	328503423	527	910	985	7.8	1.28	3.7
	2600	70	328503426	596	1029	1114	8.8	1.28	34.4
	3000	70	328503430	687	1187	1285	10.2	1.28	39.3
Type 22									
	400	102	328504404	112	197	213	1.4	1.31	7.7
	500	102	328504405	141	246	267	1.7	1.31	9.1
	600	102	328504406	169	295	321	2.0	1.31	16
	700	102	328504407	197	345	374	2.4	1.31	12.0
	800	102	328504408	225	394	427	2.7	1.31	13.4
	900	102	328504409	253	443	481	3.1	1.31	14.8
	1000	102	328504410	282	492	534	3.4	1.31	16.3
	1100	102	328504411	310	542	587	3.7	1.31	17.7
	1200	102	328504412	338	591	641	4.1	1.31	19.1
	1400	102	328504414	394	689	747	4.8	1.31	22.0
	1600	102	328504416	451	788	854	5.4	1.31	24.8
	1800	102	328504418	507	886	961	6.1	1.31	27.8
	2000	102	328504420	563	985	1068	6.8	1.31	3.7
	2300	102	328504423	648,647	1132	1228	7.8	1.31	34.9
	2600	102	328504426	732	1280	1388	8.8	1.31	39.2
	3000	102	328504430	845	1477	1602	10.2	1.31	44.8



300

HØJDE 300 mm	LÆNGDE	DYBDE	Varenr./ VVS	EFFEKT (W) 45/35/20°C	EFFEKT (W) 55/45/20°C	EFFEKT (W) 60/45/20°C	VOLUMEN (l)	N- ekponent	VÆGT (kg)
Type 33									
400	152	328506404	157	275	299	2.0	1.31	11.2	
500	152	328506405	197	344	374	2.5	1.31	13.2	
600	152	328506406	236	413	448	3.1	1.31	15.3	
700	152	328506407	275	482	523	3.6	1.31	17.4	
800	152	328506408	314	551	598	4.1	1.31	19.4	
900	152	328506409	353	620	672	4.6	1.31	21.5	
1000	152	328506410	393	688	747	5.1	1.31	23.5	
1100	152	328506411	432	757	822	5.6	1.31	25.6	
1200	152	328506412	471	826	896	6.1	1.31	27.7	
1400	152	328506414	550	964	1046	7.1	1.31	31.8	
1600	152	328506416	629	1101	1195	8.2	1.31	35.9	
1800	152	328506418	707	1239	1344	9.2	1.31	4.2	
2000	152	328506420	786	1377	1493	10.2	1.31	44.3	
2300	152	328506423	904	1583	1717	11.7	1.31	5.4	
2600	152	328506426	1021	1790	1941	13.3	1.31	56.6	
3000	152	328506430	1179	2065	2240	15.3	1.31	64.7	



400

HØJDE 400 mm	LÆNGDE	DYBDE	Varenr./ VVS	EFFEKT (W) 45/35/20°C	EFFEKT (W) 55/45/20°C	EFFEKT (W) 60/45/20°C	VOLUMEN (l)	N- ekponent	VÆGT (kg)
Type 11									
400	60	328511404	84	146	158	0.9	1.30	5.9	
500	60	328511405	105	183	198	1.1	1.30	7.0	
600	60	328511406	126	219	238	1.3	1.30	8.4	
700	60	328511407	147	256	277	1.5	1.30	9.2	
800	60	328511408	168	292	317	1.8	1.30	1.3	
900	60	328511409	189	329	357	2.0	1.30	11.4	
1000	60	328511410	210	366	396	2.2	1.30	12.4	
1100	60	328511411	231	402	436	2.4	1.30	13.5	
1200	60	328511412	251	439	475	2.6	1.30	14.6	
1400	60	328511414	294,293	512	555,554	3.1	1.30	16.8	
1600	60	328511416	335	585	634	3.5	1.30	18.9	
1800	60	328511418	377	658	713	4.0	1.30	21.4	
2000	60	328511420	419	731	792	4.4	1.30	23.5	
2300	60	328511423	482	841	911	5.1	1.30	26.7	
2600	60	328511426	545	950	1030	5.7	1.30	30.0	
3000	60	328511430	629	1097	1189	6.6	1.30	34.2	
Type 21									
400	70	328513404	114	199	215	1.8	1.29	8.6	
500	70	328513405	143	249	270	2.3	1.29	1.3	
600	70	328513406	172	298	323	2.7	1.29	12.0	
700	70	328513407	200	348	377	3.1	1.29	13.6	
800	70	328513408	229	398	431	3.6	1.29	15.3	
900	70	328513409	258	448	485	4.0	1.29	17.0	
1000	70	328513410	286	497	539	4.5	1.29	18.6	
1100	70	328513411	315	547	592	5.0	1.29	2.3	



400

HØJDE 400 mm	LÆNGDE	DYBDE	Varenr./ VVS	EFFEKT (W) 45/35/20°C	EFFEKT (W) 55/45/20°C	EFFEKT (W) 60/45/20°C	VOLUMEN (l)	N- ekponent	VÆGT (kg)
	1200	70	328513412	344	597	647	5.4	1.29	22.0
	1400	70	328513414	401	696	754	6.3	1.29	25.3
	1600	70	328513416	458	796	862	7.2	1.29	28.6
	1800	70	328513418	515	895	969	8.1	1.29	32.1
	2000	70	328513420	572	994	1077	9.0	1.29	35.4
	2300	70	328513423	658	1144	1239	10.3	1.29	4.4
	2600	70	328513426	744	1293	1401	11.7	1.29	45.4
	3000	70	328513430	859	1492	1616	13.5	1.29	51.9
Type 22									
	400	102	328514404	142	249	270	1.8	1.32	10.3
	500	102	328514405	178	311	338	2.3	1.32	11.9
	600	102	328514406	213	374	406	2.7	1.32	13.8
	700	102	328514407	248	436	473	3.1	1.32	15.7
	800	102	328514408	284	498	541	3.6	1.32	17.6
	900	102	328514409	319	560	608	4.0	1.32	19.5
	1000	102	328514410	355	623	676	4.5	1.32	21.4
	1100	102	328514411	390	685	743	5.0	1.32	23.4
	1200	102	328514412	426	747	811	5.4	1.32	25.3
	1400	102	328514414	496	872	946	6.3	1.32	29.9
	1600	102	328514416	568	996	1081	7.2	1.32	32.9
	1800	102	328514418	639	1121	1216	8.1	1.32	36.9
	2000	102	328514420	709	1245	1351	9.0	1.32	4.8
	2300	102	328514423	816	1432	1554	10.3	1.32	46.5
	2600	102	328514426	922	1619	1757	11.7	1.32	52.2
	3000	102	328514430	1064	1868	2027	13.5	1.32	59.8

Type 33



400

HØJDE 400 mm	LÆNGDE	DYBDE	Varenr./ VVS	EFFEKT (W) 45/35/20°C	EFFEKT (W) 55/45/20°C	EFFEKT (W) 60/45/20°C	VOLUMEN (l)	N- ekponent	VÆGT (kg)
400	152	152	328516404	196	345	375	2.7	1.33	14.6
500	152	152	328516405	245	432	469	3.4	1.33	16.9
600	152	152	328516406	294	518	562	4.0	1.33	19.8
700	152	152	328516407	343	604	656	4.7	1.33	22.5
800	152	152	328516408	392	691	750	5.4	1.33	25.3
900	152	152	328516409	441	777	843	6.0	1.33	28.2
1000	152	152	328516410	490	863	937	6.7	1.33	4.0
1100	152	152	328516411	539	950	1031	7.4	1.33	33.8
1200	152	152	328516412	588	1036	1125	8.0	1.33	36.6
1400	152	152	328516414	686	1209	1312	9.4	1.33	42.3
1600	152	152	328516416	784	1381	1499	10.7	1.33	47.9
1800	152	152	328516418	882	1554	1687	12.1	1.33	53.7
2000	152	152	328516420	980	1726	1874	13.4	1.33	59.4
2300	152	152	328516423	1128	1985	2155	15.4	1.33	67.9
2600	152	152	328516426	1274	2244	2436	17.4	1.33	76.2
3000	152	152	328516430	1471	2590	2811	20.1	1.33	87.4



500

HØJDE 500 mm	LÆNGDE	DYBDE	Varenr./ VVS	EFFEKT (W) 45/35/20°C	EFFEKT (W) 55/45/20°C	EFFEKT (W) 60/45/20°C	VOLUMEN (l)	N- ekponent	VÆGT (kg)
Type 11									
400	60		328521404	102	178	193	1.1	1.31	7.3
500	60		328521405	127	223	241	1.4	1.31	8.5
600	60		328521406	153	267	290	1.6	1.31	10.2
700	60		328521407	178	312	338	1.9	1.31	11.2
800	60		328521408	204	356	386	2.2	1.31	12.6
900	60		328521409	229	401	434	2.4	1.31	13.9
1000	60		328521410	255	445	483	2.7	1.31	15.3
1100	60		328521411	280	490	531	3.0	1.31	16.7
1200	60		328521412	306	534	579	3.2	1.31	18.8
1400	60		328521414	357	623	676	3.8	1.31	2.8
1600	60		328521416	408	712	772	4.3	1.31	23.6
1800	60		328521418	459	801	869	4.9	1.31	26.5
2000	60		328521420	510	890	965	5.4	1.31	29.3
2300	60		328521423	586	1024	1110	6.2	1.31	33.4
2600	60		328521426	663	1158	1255	7.0	1.31	37.5
3000	60		328521430	764	1336	1448	8.1	1.31	43.0
Type 21									
400	70		328523404	136	237	257	2.2	1.31	16
500	70		328523405	170	296	321	2.8	1.31	12.7
600	70		328523406	204	356	386	3.3	1.31	14.8
700	70		328523407	237	415	450	3.9	1.31	16.9
800	70		328523408	271	474	514	4.4	1.31	19.0
900	70		328523409	305	533	578	5.0	1.31	21.7
1000	70		328523410	339	593	643	5.5	1.31	23.2
1100	70		328523411	373	652	707	6.0	1.31	25.2



500

HØJDE 500 mm	LÆNGDE	DYBDE	Varenr./ VVS	EFFEKT (W) 45/35/20°C	EFFEKT (W) 55/45/20°C	EFFEKT (W) 60/45/20°C	VOLUMEN (l)	N- ekponent	VÆGT (kg)
	1200	70	328523412	407	711	771	6.6	1.31	27.3
	1400	70	328523414	475	830	900	7.7	1.31	31.5
	1600	70	328523416	543	948	1029	8.8	1.31	35.6
	1800	70	328523418	611	1067	1157	9.9	1.31	40.0
	2000	70	328523420	678	1185	1285	11.0	1.31	44.1
	2300	70	328523423	780	1363	1478	12.7	1.31	5.4
	2600	70	328523426	882	1541	1671	14.3	1.31	56.6
	3000	70	328523430	1018	1778	1928	16.5	1.31	64.9
Type 22									
	400	102	328524404	169	299	324	2.2	1.33	12.5
	500	102	328524405	212	373	405	2.8	1.33	14.5
	600	102	328524406	254	448	486	3.3	1.33	16.9
	700	102	328524407	296	522	567	3.9	1.33	19.4
	800	102	328524408	339	597	648	4.4	1.33	21.9
	900	102	328524409	381	672	729	5.0	1.33	24.3
	1000	102	328524410	424	746	810	5.5	1.33	26.8
	1100	102	328524411	466	821	891	6.0	1.33	29.3
	1200	102	328524412	508	896	972	6.6	1.33	31.8
	1400	102	328524414	593	1045	1134	7.7	1.33	36.6
	1600	102	328524416	678	1194	1296	8.8	1.33	41.5
	1800	102	328524418	763,762	1343	1458	9.9	1.33	46.6
	2000	102	328524420	847	1493	1620	11.0	1.33	51.6
	2300	102	328524423	974	1717	1863	12.7	1.33	58.9
	2600	102	328524426	1101	1940	2106	14.3	1.33	66.3
	3000	102	328524430	1271	2239	2431	16.5	1.33	76.3
Type 33									



500

HØJDE 500 mm	LÆNGDE	DYBDE	Varenr./ VVS	EFFEKT (W) 45/35/20°C	EFFEKT (W) 55/45/20°C	EFFEKT (W) 60/45/20°C	VOLUMEN (l)	N- ekponent	VÆGT (kg)
	400	152	328526404	232	411	447	3.3	1.34	171
	500	152	328526405	291	514	559	4.1	1.34	2.8
	600	152	328526406	348	617	670	4.9	1.34	24.4
	700	152	328526407	407	719	782	5.7	1.34	28.7
	800	152	328526408	465	822	893	6.6	1.34	31.7
	900	152	328526409	523	925	1005	7.4	1.34	35.3
	1000	152	328526410	581	1028	1116	8.2	1.34	39.0
	1100	152	328526411	639	1131	1228	9.0	1.34	42.6
	1200	152	328526412	697	1233	1340	9.8	1.34	46.3
	1400	152	328526414	813	1439	1563	11.5	1.34	53.5
	1600	152	328526416	929	1645	1786	13.1	1.34	6.8
	1800	152	328526418	1045	1850	2010	14.8	1.34	68.3
	2000	152	328526420	1162	2056	2233	16.4	1.34	75.5
	2300	152	328526423	1336	2364	2568	18.9	1.34	86.5
	2600	152	328526426	1510	2672	2903	21.3	1.34	101.2
	3000	152	328526430	1742	3084	3349	24.6	1.34	111.8



600

HØJDE 600 mm	LÆNGDE	DYBDE	Varenr./ VVS	EFFEKT (W) 45/35/20°C	EFFEKT (W) 55/45/20°C	EFFEKT (W) 60/45/20°C	VOLUMEN (l)	N- ekponent	VÆGT (kg)
Type 11									
	400	60	328531404	119	208	226	1.3	1.31	8.4
	500	60	328531405	149	260	282	1.6	1.31	1.2
	600	60	328531406	179	313	339	1.9	1.31	11.7
	700	60	328531407	208	365	396	2.2	1.31	13.3
	800	60	328531408	238	417	452	2.6	1.31	14.9
	900	60	328531409	268	469	508	2.9	1.31	16.6
	1000	60	328531410	298	521	565	3.2	1.31	18.2
	1100	60	328531411	327	573	622	3.5	1.31	19.8
	1200	60	328531412	357	625	678	3.8	1.31	21.5
	1400	60	328531414	417	729	791	4.5	1.31	24.7
	1600	60	328531416	476	834	904	5.1	1.31	28.0
	1800	60	328531418	536	938	1017	5.8	1.31	31.5
	2000	60	328531420	595	1042	1130	6.4	1.31	34.7
	2300	60	328531423	684	1198	1299	7.4	1.31	39.6
	2600	60	328531426	774	1354	1469	8.3	1.31	44.5
	3000	60	328531430	893	1563	1695	9.6	1.31	6.0
Type 21									
	400	70	328533404	155	273	296	2.6	1.32	12.5
	500	70	328533405	194	341	370	3.3	1.32	15.1
	600	70	328533406	233	409	444	4.0	1.32	17.6
	700	70	328533407	272	478	518	4.6	1.32	2.1
	800	70	328533408	311	546	592	5.3	1.32	22.6
	900	70	328533409	349	614	666	5.9	1.32	25.2
	1000	70	328533410	388	682	740	6.6	1.32	27.7
	1100	70	328533411	427	751	814	7.3	1.32	3.3



600

HØJDE 600 mm	LÆNGDE	DYBDE	Varenr./ VVS	EFFEKT (W) 45/35/20°C	EFFEKT (W) 55/45/20°C	EFFEKT (W) 60/45/20°C	VOLUMEN (l)	N- ekponent	VÆGT (kg)
	1200	70	328533412	466	819	889	7.9	1.32	32.8
	1400	70	328533414	543	955	1037	9.2	1.32	37.9
	1600	70	328533416	621	1092	1185	10.6	1.32	43.1
	1800	70	328533418	699	1228	1333	11.9	1.32	48.3
	2000	70	328533420	776	1365	1481	13.2	1.32	53.4
	2300	70	328533423	893	1569	1703	15.2	1.32	7.0
	2600	70	328533426	1009	1774	1925	17.2	1.32	68.6
	3000	70	328533430	1165,1164	2047	2221	19.8	1.32	78.7
Type 22									
	400	102	328534404	195	346	375	2.6	1.34	14.5
	500	102	328534405	244	432	469	3.3	1.34	17.5
	600	102	328534406	293	518	563	4.0	1.34	2.5
	700	102	328534407	342	605	657	4.6	1.34	23.4
	800	102	328534408	391	691	750	5.3	1.34	26.4
	900	102	328534409	440	777	844	5.9	1.34	29.4
	1000	102	328534410	488	864	938	6.6	1.34	32.3
	1100	102	328534411	537	950	1032	7.3	1.34	35.3
	1200	102	328534412	586	1037	1126	7.9	1.34	38.3
	1400	102	328534414	684	1209	1314	9.2	1.34	44.2
	1600	102	328534416	781	1382	1501	10.6	1.34	5.1
	1800	102	328534418	879	1555	1689	11.9	1.34	56.3
	2000	102	328534420	977	1728	1876	13.2	1.34	62.1
	2300	102	328534423	1124,1123	1987	2158,2157	15.2	1.34	71.3
	2600	102	328534426	1270	2246	2439	17.2	1.34	79.9
	3000	102	328534430	1465	2591	2815	19.8	1.34	91.7

Type 33



600

HØJDE 600 mm	LÆNGDE	DYBDE	Varenr./ VVS	EFFEKT (W) 45/35/20°C	EFFEKT (W) 55/45/20°C	EFFEKT (W) 60/45/20°C	VOLUMEN (l)	N- ekponent	VÆGT (kg)
	400	152	328536404	266	473	514	3.9	1.35	19.9
	500	152	328536405	333	592	643	4.9	1.35	24.3
	600	152	328536406	399	710	772	5.9	1.35	28.8
	700	152	328536407	466	828	900	6.9	1.35	33.2
	800	152	328536408	532	946	1029	7.8	1.35	37.6
	900	152	328536409	599	1065	1157	8.8	1.35	42.3
	1000	152	328536410	665	1183	1286	9.8	1.35	46.5
	1100	152	328536411	732	1301	1415	10.8	1.35	5.9
	1200	152	328536412	798	1420	1543	11.8	1.35	55.3
	1400	152	328536414	931	1656	1800	13.7	1.35	64.1
	1600	152	328536416	1064	1893	2058	15.7	1.35	73.0
	1800	152	328536418	1197	2129	2315	17.6	1.35	82.0
	2000	152	328536420	1330	2366	2572	19.6	1.35	9.8
	2300	152	328536423	1530	2721	2958	22.5	1.35	108.2
	2600	152	328536426	1730	3076	3344,3343	25.5	1.35	117.4
	3000	152	328536430	1996	3549	3858	29.4	1.35	134.9



900

HØJDE 900 mm	LÆNGDE	DYBDE	Varenr./ VVS	EFFEKT (W) 45/35/20°C	EFFEKT (W) 55/45/20°C	EFFEKT (W) 60/45/20°C	VOLUMEN (l)	N- ekponent	VÆGT (kg)
Type 11									
	400	60	328541404	166	291	316	1.8	1.32	11.8
	500	60	328541405	208	364	395	2.3	1.32	14.4
	600	60	328541406	249	437	474	2.7	1.32	17.0
	700	60	328541407	291	510	553	3.1	1.32	19.4
	800	60	328541408	332	583	632	3.6	1.32	22.0
	900	60	328541409	373	655	711	4.0	1.32	24.5
	1000	60	328541410	415	728	790	4.5	1.32	27.6
	1100	60	328541411	457	801	869	5.0	1.32	29.6
	1200	60	328541412	498	874	948	5.4	1.32	32.1
	1400	60	328541414	581	1019	1106	6.3	1.32	37.3
	1600	60	328541416	664	1165	1264	7.2	1.32	42.3
	1800	60	328541418	747	1311	1422	8.1	1.32	47.5
	2000	60	328541420	830	1456	1580	9.0	1.32	52.6
Type 21									
	400	70	328543404	212	376	408	3.6	1.34	17.7
	500	70	328543405	265	470	510	4.5	1.34	21.6
	600	70	328543406	318	563	612	5.4	1.34	25.5
	700	70	328543407	371	657	714	6.3	1.34	29.4
	800	70	328543408	424	751	816	7.2	1.34	33.3
	900	70	328543409	477	845	918	8.1	1.34	37.2
	1000	70	328543410	530	939	1020	9.0	1.34	41.8
	1100	70	328543411	583	1033	1122	9.9	1.34	45.0
	1200	70	328543412	636	1127	1224	10.8	1.34	48.9
	1400	70	328543414	742	1315	1428	12.6	1.34	56.6
	1600	70	328543416	848	1502	1632	14.4	1.34	64.4



900

HØJDE 900 mm	LÆNGDE	DYBDE	Varenr./ VVS	EFFEKT (W) 45/35/20°C	EFFEKT (W) 55/45/20°C	EFFEKT (W) 60/45/20°C	VOLUMEN (l)	N- ekponent	VÆGT (kg)
	1800	70	328543418	954	1690	1836	16.2	1.34	72.3
	2000	70	328543420	1060	1878	2040	18.0	1.34	8.1
Type 22									
	400	102	328544404	268	478	520	3.6	1.36	2.8
	500	102	328544405	335	597	650	4.5	1.36	25.4
	600	102	328544406	402	717	780	5.4	1.36	29.9
	700	102	328544407	469	836	910,909	6.3	1.36	34.4
	800	102	328544408	536	956	1039	7.2	1.36	38.9
	900	102	328544409	603	1075	1169	8.1	1.36	43.5
	1000	102	328544410	670	1194	1299	9.0	1.36	48.1
	1100	102	328544411	737	1314	1429	9.9	1.36	52.5
	1200	102	328544412	804	1433	1559	10.8	1.36	57.7
	1400	102	328544414	937	1672	1819	12.6	1.36	66.2
	1600	102	328544416	1072,1071	1911	2079,2078	14.4	1.36	75.1
	1800	102	328544418	1205	2150	2338	16.2	1.36	84.4
	2000	102	328544420	1339	2389	2598	18.0	1.36	93.4
Type 33									
	400	152	328546404	364	651	708	5.3	1.36	3.3
	500	152	328546405	455	814	885	6.7	1.36	36.8
	600	152	328546406	546	976	1062	8.0	1.36	43.2
	700	152	328546407	637	1139	1239	9.3	1.36	49.6
	800	152	328546408	729	1302	1416	10.6	1.36	56.8
	900	152	328546409	820	1465	1593	12.0	1.36	62.5
	1000	152	328546410	911	1627	1770	13.3	1.36	69.0
	1100	152	328546411	1002	1790	1947	14.6	1.36	75.4
	1200	152	328546412	1093	1953	2124	16.0	1.36	81.8



900

HØJDE 900 mm	LÆNGDE	DYBDE	Varenr./ VVS	EFFEKT (W) 45/35/20°C	EFFEKT (W) 55/45/20°C	EFFEKT (W) 60/45/20°C	VOLUMEN (l)	N- ekponent	VÆGT (kg)
	1400	152	328546414	1275	2278	2478	18.6	1.36	94.7
	1600	152	328546416	1457	2604	2832	21.3	1.36	111.8
	1800	152	328546418	1639	2929	3187	23.9	1.36	12.6
	2000	152	328546420	1821	3255	3541	26.6	1.36	133.5