



**Datablad**

2026-07-02

# Compact ©

Standard radiator med 4 x 1/2" tilslutning, topriste og sidepaneler.

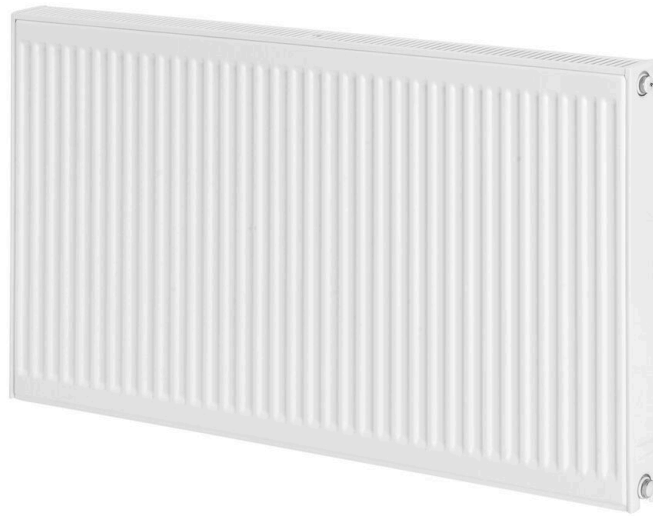

- ✓ Toprist og sideplader på alle modeller
- ✓ Kan monteres på gulvkonsole
- ✓ Flere forskellige tilslutningsmuligheder
- ✓ Effektiv varmfordeling
- ✓ Bredt udvalg af farver

Compact er en traditionel panelradiator til lukkede, vandbaserede varmesystemer med et neutralt design. Compact panelradiator har fire G 1/2"-tilslutninger med indvendigt gevind, der giver mulighed for tilslutning i højre eller venstre side. Det er en radiator, der tilbyder høj kvalitet, fremragende finish og markedets bredeste sortiment. Compact er designet til optimal varmfordeling i henhold til standarden EN442-1, og alle modeller er CE-mærket. Compact leveres med monterede sidepaneler og topriste med børnesikker fastgørelse. Beslag, riste, sidepaneler, blindprop og udluftningsskrue medfølger. Der skal tages højde for driftsforholdene, og installationsanvisningerne skal følges under installationen. Standard hvid RAL 9016 finish (andre farver fås efter anmodning mod et ekstra gebyr). Garantiperioden er 10 år.



### Anvendelsesområde

Egnet til boliger og erhvervsbygninger, der kræver højt tryk op til 10 bar. Ideel til fler-etagers bygninger, fjernvarmesystemer og større installationer. Kompatibel med systemer med maksimale driftstemperaturer på 110°C og forsynet med lodrette vandkanaler med 33,3 mm afstand for effektiv varmfordeling

### Dimensionering

Brug vores designservice til detaljeret udvælgelse eller se vores brochure for hurtig udvælgelse

### Anvendelse

Sørg for, at installationen udføres ved hjælp af de medfølgende MCW-7 vægbeslag for stabilitet. Radiatorforbindelser laves gennem 4 x G 1/2" sideåbninger. Regelmæssig vedligeholdelse er

nødvendig for at sikre optimal ydeevne. Maksimale driftsparametre inkluderer et arbejdstryk på 10 bar og en driftstemperatur op til 110°C

### AMA-tekst

Den Compact (33.3) radiator fra Purmo er designet til højtryksanvendelser med et maksimalt arbejdstryk på 10 bar og en maksimal driftstemperatur på 110°C. Den har dybtrukket, lavkulstof koldvalset stål i overensstemmelse med EN 10130. Radiatoren har lodrette vandkanaler med 33,3 mm afstand for effektiv varmfordeling og leveres med fabriksmonterede sidepaneler og en topgrill. Standardfarven er hvid RAL 9016, men andre farver kan fås efter anmodning. Tilslutninger sker via 4 x G 1/2" sideåbninger, og radiatoren leveres med vægbeslag, propper og en luftventil. Fås i flere størrelser og opfylder både bolig- og erhvervsbehov, hvilket gør den velegnet til fler-etagers bygninger og fjernvarmesystemer



# Specifikationer

EGENSKABER	ENHED	VÆRDIER
ETIM-klasse		EC011022
Materiale		Stål
Type		11, 21, 22, 33
Overfladestruktur		Profileret
Maks. arbejdsstryk	bar	10
Antal standardtilslutninger		4
Varmeafgivelse iht. anerkendt EN 442-laboratorium		Ja
Maks. driftstemperatur	°C	110
Standardfarve		Ja
Farve		Hvid
RAL-nummer		9016
Gitter/Dækkplade		Ja
Gitter/Dækkplade		Ja
Glansværdi		Glansfuld
Gængedimension (tomme)		1/2 tomme
Tilslutning gevind		Intern gevind
Med etpunkttilslutning		Ja
Med udluftningstilslutning		Ja
Med udluftningsventil/aflufter		Ja
Med aftapningsmulighed		Ja



# Dokumenter

DOKUMENTER	DOKUMENTTYPE	LINK
Taethedstest	Installation	<a href="https://asset.productmarketingcloud.com/api/assetstorage/3577_c37363c0-7a55-470a-bf93-031f44c77bbe">https://asset.productmarketingcloud.com/api/assetstorage/3577_c37363c0-7a55-470a-bf93-031f44c77bbe</a>
Varmeeffekt-beregner (EXCEL), panelradiatorer	TechDia	<a href="https://asset.productmarketingcloud.com/api/assetstorage/3577_2da398bb-5820-4a58-af2d-62333aa4e65e">https://asset.productmarketingcloud.com/api/assetstorage/3577_2da398bb-5820-4a58-af2d-62333aa4e65e</a>
Varmeeffekt-beregner (EXCEL), panelradiatorer	TechDia	<a href="https://asset.productmarketingcloud.com/api/assetstorage/3577_cab0544f-96f3-4994-bffd-08e7c8d0ba7d">https://asset.productmarketingcloud.com/api/assetstorage/3577_cab0544f-96f3-4994-bffd-08e7c8d0ba7d</a>



# Ressourcer



ProductImage - Purmo Compact, C, detail above.



ProductImage - Purmo Compact, C, product image 30 degrees.

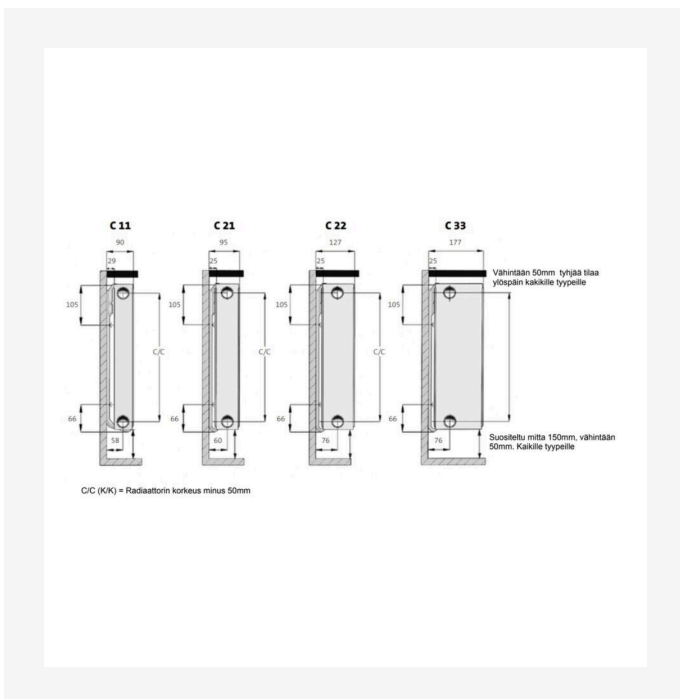

DimensionalDrawing - Monteringsvejledning til radiator

COMPACT (mm)				
	C11		C21s, C22, C33	
A	a1	a2	a1	a2
400-1600	117	-	133	-
1800	117	917	133	900
2000	117	1017	133	1000
2300	117	1150	133	1167
2600	117	1317	133	1300
3000	117	1517	133	1500

DimensionalDrawing - Compact, tabeltegning A

# Ressourcer

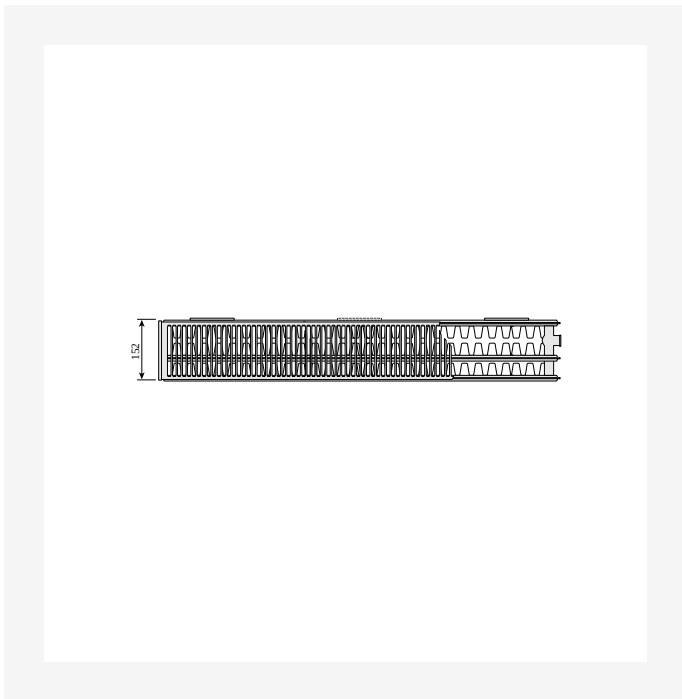

DimensionalDrawing - Compact type 33, set oppefra

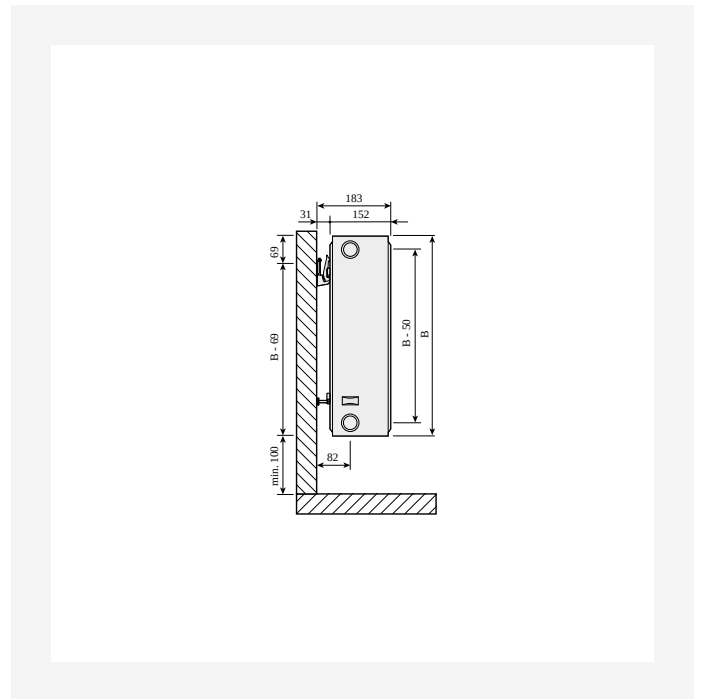

DimensionalDrawing - Compact type 33, sidevisning med SSMS vægbeslag

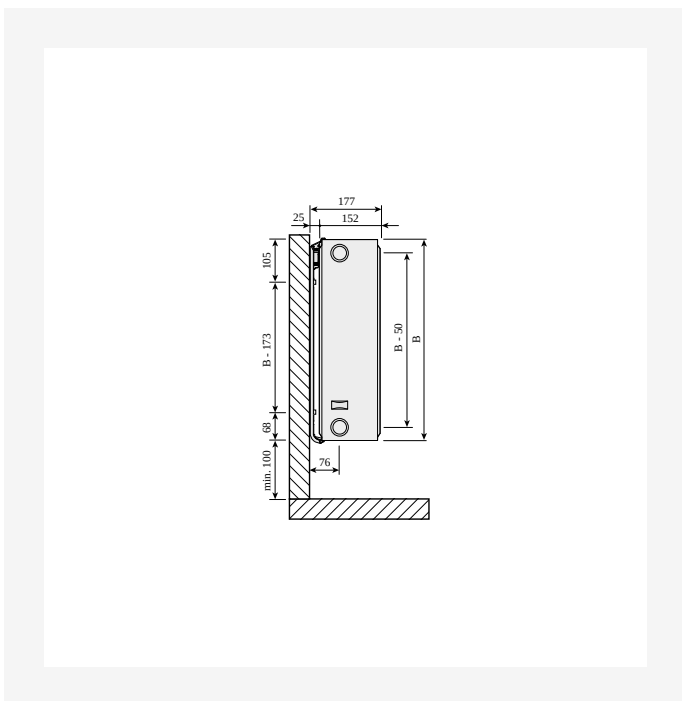

DimensionalDrawing - Compact, type 33, sidevisning med Monclac vægbeslag

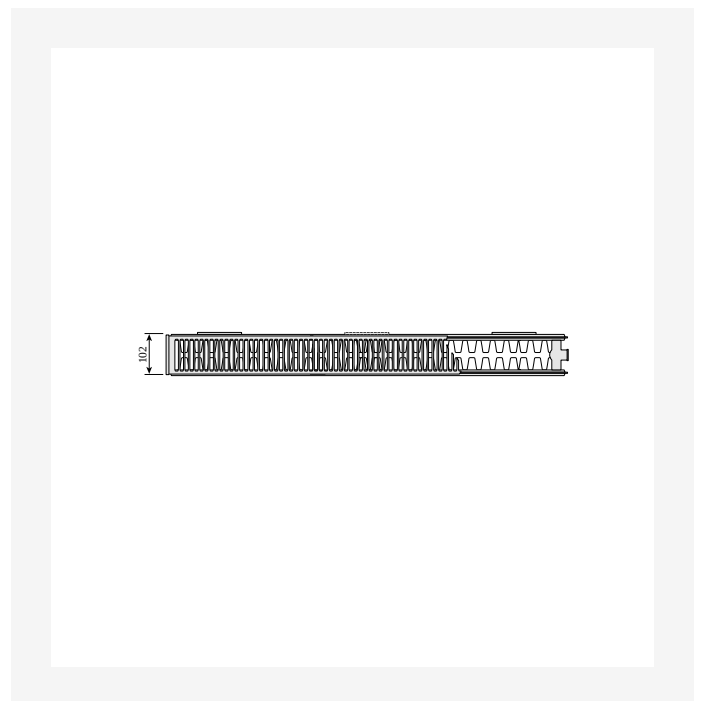

DimensionalDrawing - Compact type 22, set oppefra



# Ressourcer

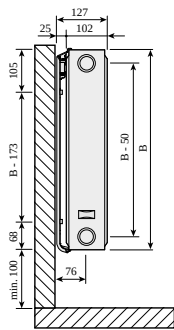

DimensionalDrawing - Compact, type 22, sidevisning med Monclac vægbeslag

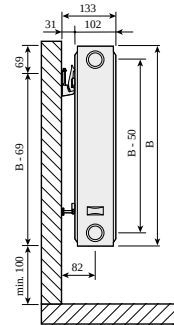

DimensionalDrawing - Compact type 22, sidevisning med SSMS vægbeslag



DimensionalDrawing - Compact type 21, set oppefra

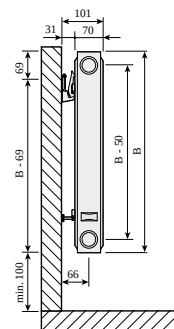

DimensionalDrawing - Compact type 21, sidevisning med SSMS vægbeslag



# Ressourcer

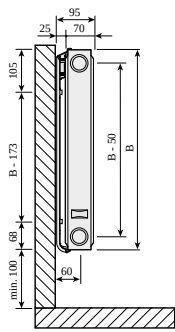

DimensionalDrawing - Compact, type 21, sidevisning med Monclac vægbeslag

DimensionalDrawing - Compact type 11, set oppefra

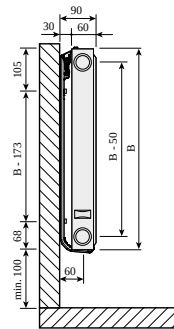
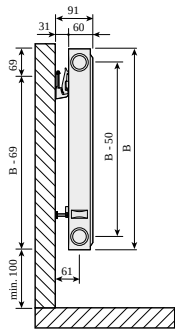

DimensionalDrawing - Compact type 11, sidevisning med SSMS vægbeslag

DimensionalDrawing - Compact, type 11, sidevisning med Monclac vægbeslag



# Ressourcer

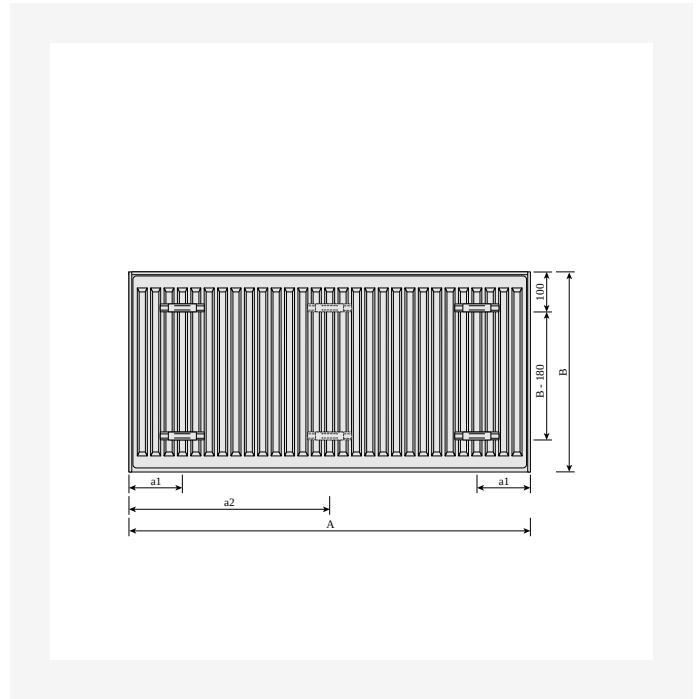
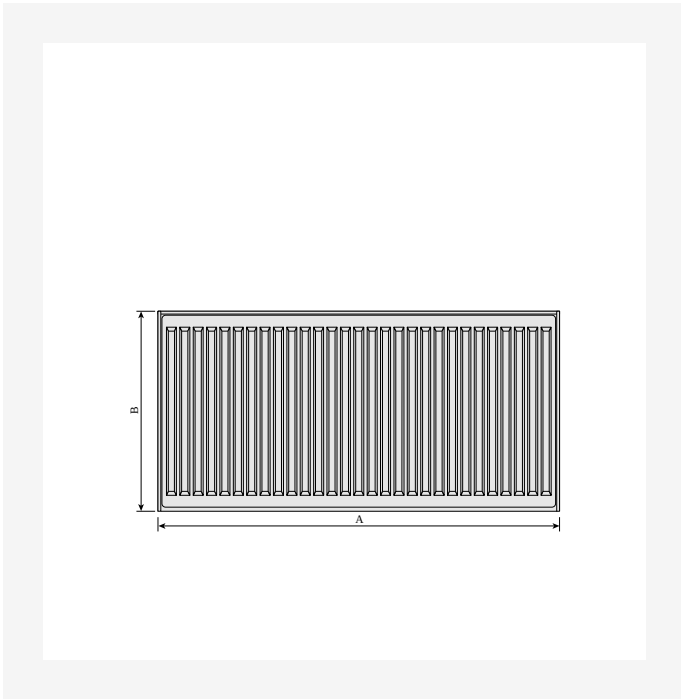

DimensionalDrawing - Compact, forfra

DimensionalDrawing - Compact, bagfra

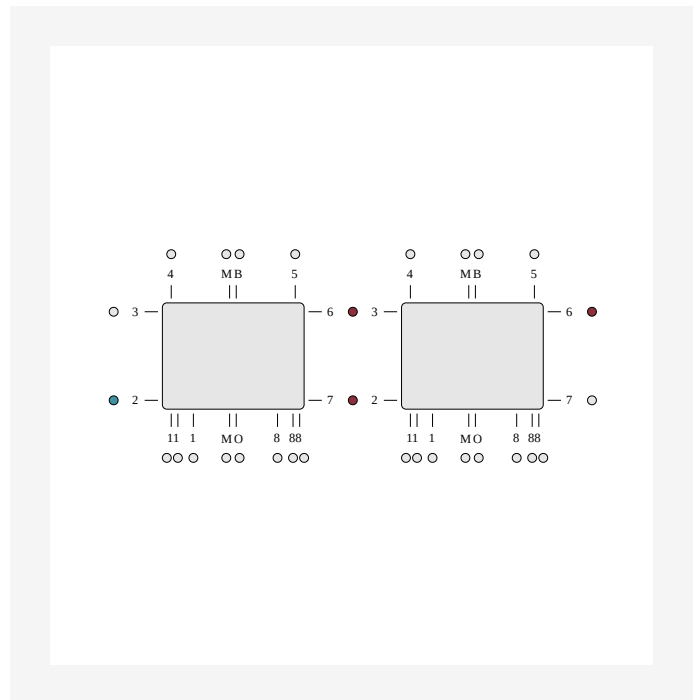
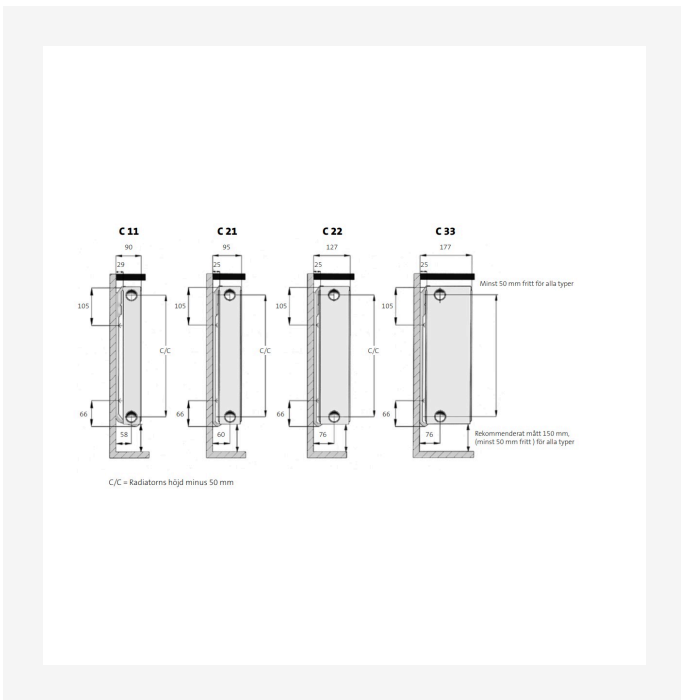

DimensionalDrawing - Installationsmål

DimensionalDrawing - ETIM 62 Serieforbindelse vandret tilslutning

# Ressourcer

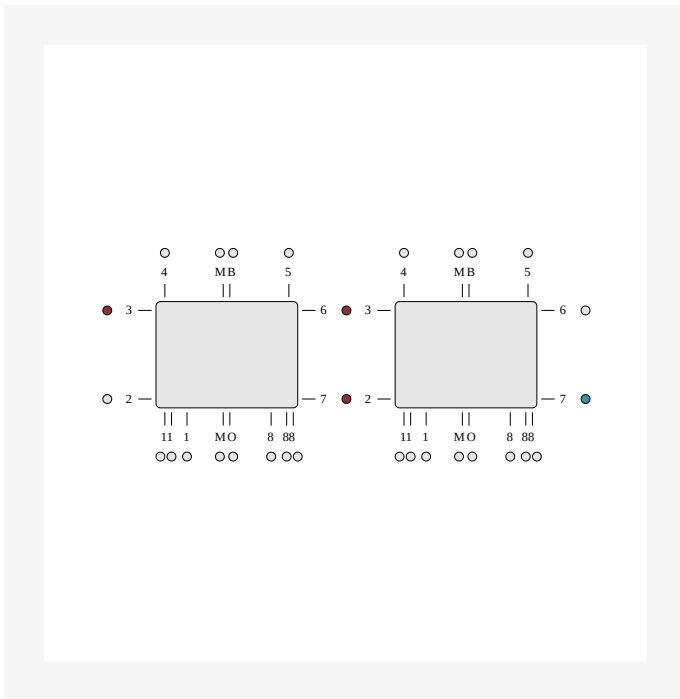

DimensionalDrawing - ETIM 37 Serieforbindelse vandret tilslutning

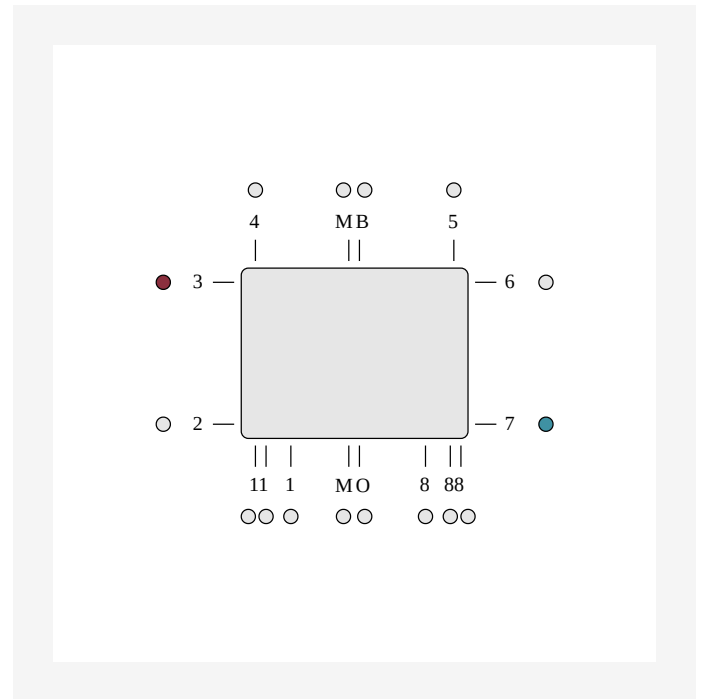

DimensionalDrawing - Diagonal tilslutning ETIM 37. Diagonal tilslutning kræver brug af en ekstern ventil. Ved diagonal tilslutning er bundtilslutningerne lukkede.

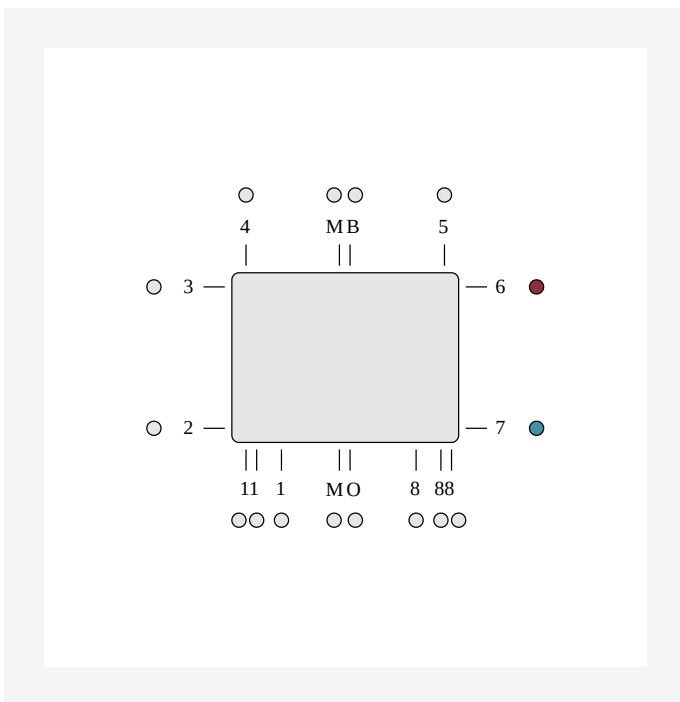

DimensionalDrawing - Sideforbindelse ETIM 67. Sideforbindelse kræver brug af en ekstern radiatorfitting eller ventil. Ved sideforbindelse tilstoppes bundtilslutningerne.

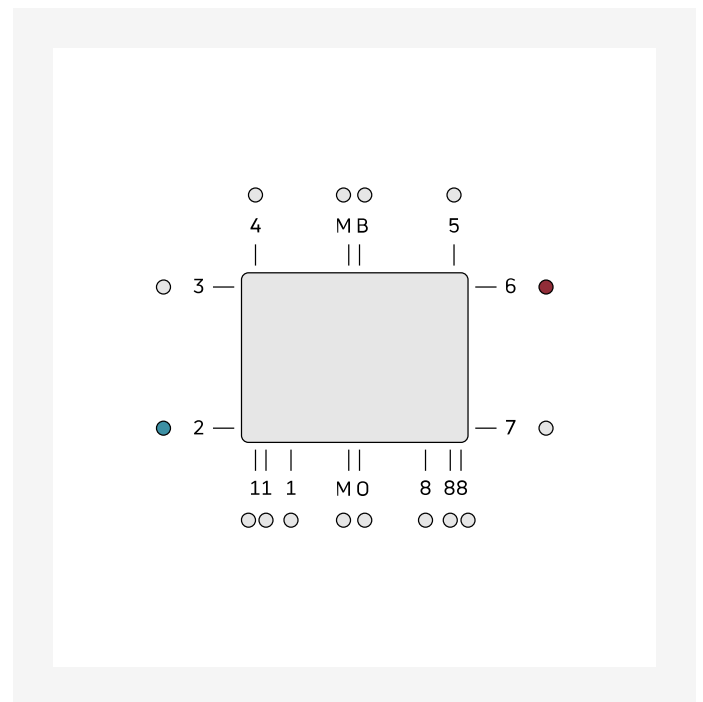

DimensionalDrawing - Diagonalforbindelse ETIM 62. Diagonalforbindelse kræver brug af en ekstern ventil. Ved diagonalforbindelse tilstoppes bundtilslutningerne.



# Ressourcer

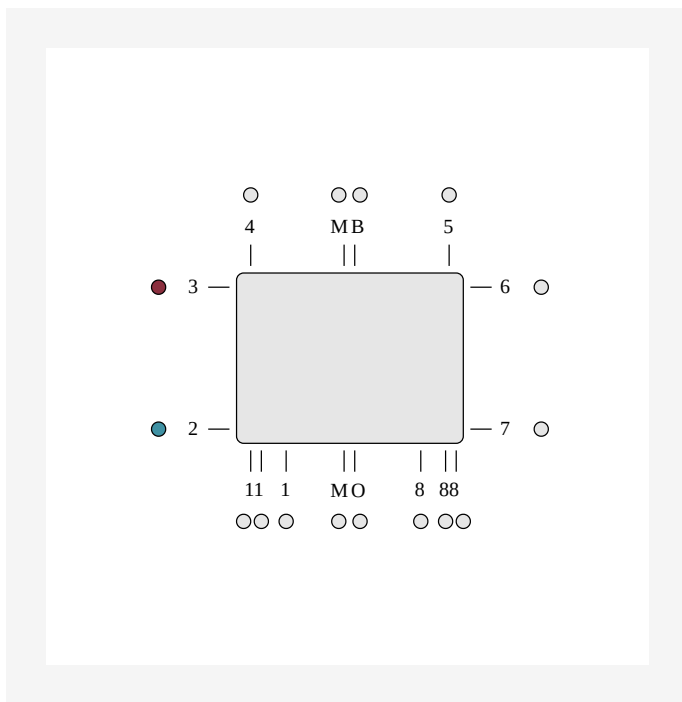

DimensionalDrawing - Sideforbindelse ETIM 32.  
Sideforbindelse kræver brug af en ekstern radiatorventil.  
Ved sideforbindelse tilstoppes bundtilslutningerne.



# Relaterede produkter



Sensor



Toprist Purmo



Air



Udluftningskrue og blindprop



Reparationslak



Purmo sidepanel



Air Vent 1/2"



Vægbeslag Monclac



Udluftningsnøgle



Flex Radiatorkobling

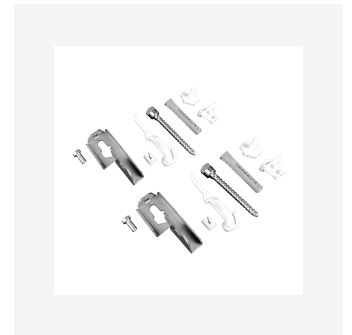

Vægbeslag SSMS



# Relaterede produkter



Holderbøjle



Termostat Evosense



Returventil RV

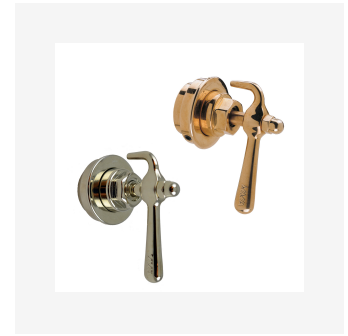

Slotsventil, håndhjul



Termostat Evosense Sprint



Gulvstøtte med dækskive



Evoflow Radiatorventil



Termostat Evosense Public

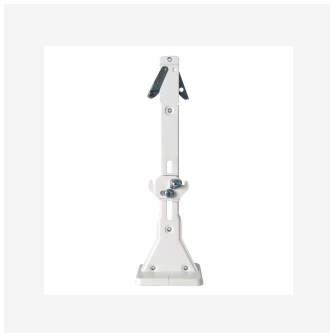

Gulvkonsol Purmo Monclac

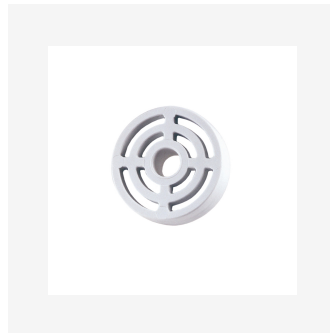

Vægafstand



Termostat Evosense Remote



Safety Bracket



# 300

HØJDE 300 mm	LÆNGDE	DYBDE	Varenr./ VVS (V)	Varenr./ VVS(H)	EFFEKT (W) 45/35/20°C	EFFEKT (W) 55/45/20°C	EFFEKT (W) 60/45/20°C	VOLUMEN (l)	N- ekponent	VÆGT (kg)
<b>Type 11</b>										
400	60	F061103004010H00	328631104	65	113	122	0.7	1.30	4.4	
500	60	F061103005010H00	328631105	81	141	152	0.8	1.30	5.1	
600	60	F061103006010H00	328631106	97	169	183	1.0	1.30	5.9	
700	60	F061103007010H00	328631107	113	197	213	1.2	1.30	6.7	
800	60	F061103008010H00	328631108	129	225	244	1.4	1.30	7.5	
900	60	F061103009010H00	328631109	146,145	253	274	1.5	1.30	8.3	
1000	60	F061103010010H00	328631110	162	281	305	1.7	1.30	9.2	
1100	60	F061103011010H00	328631111	178	309	336,335	1.9	1.30	10.0	
1200	60	F061103012010H00	328631112	194	338	366	2.0	1.30	1.6	
1400	60	F061103014010H00	328631114	226	394	427	2.4	1.30	12.2	
1600	60	F061103016010H00	328631116	259	450	488	2.7	1.30	13.8	
1800	60	F061103018010H00	328631118	291	506	549	3.1	1.30	15.4	
2000	60	F061103020010H00	328631120	323	563	610	3.4	1.30	17.0	
2300	60	F061103023010H00	328631123	372	647	701	3.9	1.30	19.4	
2600	60	F061103026010H00	328631126	420	731	793,792	4.4	1.30	21.7	
3000	60	F061103030010H00	328631130	485	844	915,914	5.1	1.30	24.9	
<b>Type 21</b>										
400	70	F062103004010H00	328633104	92	158	171	1.4	1.28	6.2	
500	70	F062103005010H00	328633105	115	198	214	1.7	1.28	7.4	
600	70	F062103006010H00	328633106	138,137	237	257	2.0	1.28	8.6	
700	70	F062103007010H00	328633107	160	277	300	2.4	1.28	10.0	
800	70	F062103008010H00	328633108	183	317	343	2.7	1.28	11.3	
900	70	F062103009010H00	328633109	206	356	386,385	3.1	1.28	12.3	
1000	70	F062103010010H00	328633110	229	396	428	3.4	1.28	13.6	



# 300

HØJDE 300 mm	LÆNGDE	DYBDE	Varenr./ VVS (V)	Varenr./ VVS(H)	EFFEKT (W) 45/35/20°C	EFFEKT (W) 55/45/20°C	EFFEKT (W) 60/45/20°C	VOLUMEN (l)	N- ekponent	VÆGT (kg)
	1100	70	F062103011010H00	328633111	252	435	471	3.7	1.28	14.8
	1200	70	F062103012010H00	328633112	275	475	514	4.1	1.28	16.4
	1400	70	F062103014010H00	328633114	321	554	600,599	4.8	1.28	18.7
	1600	70	F062103016010H00	328633116	367	633	686,685	5.4	1.28	21.1
	1800	70	F062103018010H00	328633118	412	712	771	6.1	1.28	23.6
	2000	70	F062103020010H00	328633120	458	791	857,856	6.8	1.28	26.1
	2300	70	F062103023010H00	328633123	527	910	985	7.8	1.28	30.0
	2600	70	F062103026010H00	328633126	596	1029	1114,113	8.8	1.28	33.7
	3000	70	F062103030010H00	328633130	687	1187	1285	10.2	1.28	38.7
<b>Type 22</b>										
	400	102	F062203004010H00	328634104	113,112	197	213	1.4	1.31	7.2
	500	102	F062203005010H00	328634105	141	246	267	1.7	1.31	8.5
	600	102	F062203006010H00	328634106	169	295	321,320	2.0	1.31	10.1
	700	102	F062203007010H00	328634107	197	345	374	2.4	1.31	11.4
	800	102	F062203008010H00	328634108	225	394	427	2.7	1.31	12.8
	900	102	F062203009010H00	328634109	253	443	481,480	3.1	1.31	14.2
	1000	102	F062203010010H00	328634110	282	492	534	3.4	1.31	15.6
	1100	102	F062203011010H00	328634111	310	542	587	3.7	1.31	17.4
	1200	102	F062203012010H00	328634112	338	591	641,640	4.1	1.31	18.5
	1400	102	F062203014010H00	328634114	394	689	747	4.8	1.31	21.3
	1500	102	328634115		422	738	--	5.1	1.31	22.7
	1600	102	328634116		451	788	854	5.4	1.31	24.2
	1800	102	328634118		507	886	961	6.1	1.31	27.1
	2000	102	328634120		563	985	1067	6.8	1.31	29.9
	2300	102	328634123		648	1132	1228	7.8	1.31	34.1
	2600	102	328634126		732	1280	1388	8.8	1.31	38.5



# 300

HØJDE 300 mm	LÆNGDE	DYBDE	Varenr./ VVS (V)	Varenr./ VVS(H)	EFFEKT (W) 45/35/20°C	EFFEKT (W) 55/45/20°C	EFFEKT (W) 60/45/20°C	VOLUMEN (l)	N- ekponent	VÆGT (kg)
	3000	102	328634130		845	1477	1601	10.2	1.31	44.9
<b>Type 33</b>										
	400	152	328636104		157	275	299	2.0	1.31	1.3
	500	152	328636105		196	344	373	2.5	1.31	12.4
	600	152	328636106		236	413	448	3.1	1.31	14.5
	700	152	328636107		275	482	523	3.6	1.31	16.7
	800	152	328636108		314	551	597	4.1	1.31	18.8
	900	152	328636109		354	620	672	4.6	1.31	2.9
	1000	152	328636110		393	688	747	5.1	1.31	23.5
	1100	152	328636111		432	757	821	5.6	1.31	25.2
	1200	152	328636112		472	826	896	6.1	1.31	27.3
	1400	152	328636114		550	964	1045	7.1	1.31	31.6
	1600	152	328636116		629	1101	1195	8.2	1.31	35.8
	1800	152	328636118		707	1239	1344	9.2	1.31	4.7
	2000	152	328636120		786	1377	1493	10.2	1.31	44.3
	2300	152	328636123		904	1583	1717	11.7	1.31	5.7
	2600	152	328636126		1022	1790	1941	13.3	1.31	57.9
	3000	152	328636130		1179	2065	2240	15.3	1.31	65.6



## 400

HØJDE 400 mm	LÆNGDE	DYBDE	Varenr./ VVS (V)	Varenr./ VVS(H)	EFFEKT (W) 45/35/20°C	EFFEKT (W) 55/45/20°C	EFFEKT (W) 60/45/20°C	VOLUMEN (l)	N- ekponent	VÆGT (kg)
<b>Type 11</b>										
400	60		F061104004010H00	328641104	84	146	158	0.9	1.30	5.5
500	60		F061104005010H00	328641105	105	183	198	1.1	1.30	6.5
600	60		F061104006010H00	328641106	126	219	238	1.3	1.30	7.6
700	60		F061104007010H00	328641107	147	256	277	1.5	1.30	8.7
800	60		F061104008010H00	328641108	168	292	317	1.8	1.30	9.7
900	60		F061104009010H00	328641109	189	329	357,356	2.0	1.30	1.8
1000	60		F061104010010H00	328641110	210	366	396	2.2	1.30	11.8
1100	60		F061104011010H00	328641111	231	402	436	2.4	1.30	12.9
1200	60		F061104012010H00	328641112	252,251	439	475	2.6	1.30	14.0
1400	60		F061104014010H00	328641114	294,293	512	555,554	3.1	1.30	16.1
1600	60		F061104016010H00	328641116	335	585	634	3.5	1.30	18.2
1800	60		F061104018010H00	328641118	377	658	713	4.0	1.30	2.4
2000	60		F061104020010H00	328641120	419	731	792	4.4	1.30	22.5
2300	60		F061104023010H00	328641123	482	841	911	5.1	1.30	25.7
2600	60		F061104026010H00	328641126	545	950	1030	5.7	1.30	28.9
3000	60		F061104030010H00	328641130	629	1097	1189,1188	6.6	1.30	33.2
<b>Type 21</b>										
400	70		F062104004010H00	328643104	115,114	199	215	1.8	1.29	7.7
500	70		F062104005010H00	328643105	143	249	270,269	2.3	1.29	9.4
600	70		F062104006010H00	328643106	172	298	323	2.7	1.29	11.1
700	70		F062104007010H00	328643107	200	348	377	3.1	1.29	12.8
800	70		F062104008010H00	328643108	229	398	431	3.6	1.29	14.5
900	70		F062104009010H00	328643109	258	448	485	4.0	1.29	16.2
1000	70		F062104010010H00	328643110	286	497	539	4.5	1.29	17.9
1100	70		F062104011010H00	328643111	315	547	592	5.0	1.29	19.6



## 400

HØJDE 400 mm	LÆNGDE	DYBDE	Varenr./ VVS (V)	Varenr./ VVS(H)	EFFEKT (W) 45/35/20°C	EFFEKT (W) 55/45/20°C	EFFEKT (W) 60/45/20°C	VOLUMEN (l)	N- ekponent	VÆGT (kg)
	1200	70	F062104012010H00	328643112	344	597	647,646	5.4	1.29	21.3
	1400	70	F062104014010H00	328643114	401	696	754	6.3	1.29	24.6
	1600	70	F062104016010H00	328643116	458	796	862	7.2	1.29	28.3
	1800	70	F062104018010H00	328643118	515	895	969	8.1	1.29	31.4
	2000	70	F062104020010H00	328643120	573,572	994	1077	9.0	1.29	34.8
	2300	70	F062104023010H00	328643123	658	1144	1239	10.3	1.29	39.9
	2600	70	F062104026010H00	328643126	744	1293	1401,1400	11.7	1.29	44.9
	3000	70	F062104030010H00	328643130	859	1492	1616	13.5	1.29	51.7
<b>Type 22</b>										
	400	102	328644104		142	249	270	1.8	1.32	9.2
	500	102	328644105		177	311	338	2.3	1.32	11.3
	600	102	328644106		213	374	405	2.7	1.32	13.3
	700	102	328644107		248	436	473	3.1	1.32	15.0
	800	102	328644108		284	498	540	3.6	1.32	16.9
	900	102	328644109		319	560	608	4.0	1.32	18.8
	1000	102	328644110		355	623	675	4.5	1.32	2.7
	1100	102	328644111		390	685	743	5.0	1.32	22.6
	1200	102	328644112		426	747	811	5.4	1.32	24.6
	1400	102	328644114		497	872	946	6.3	1.32	28.4
	1500	102	328644115		532	934	--	6.8	1.32	3.3
	1600	102	328644116		568	996	1081	7.2	1.32	32.3
	1800	102	328644118		639	1121	1216	8.1	1.32	36.1
	2000	102	328644120		710	1245	1351	9.0	1.32	40.0
	2300	102	328644123		816	1432	1554	10.3	1.32	45.7
	2600	102	328644126		923	1619	1756	11.7	1.32	51.6
	3000	102	328644130		1064	1868	2026	13.5	1.32	59.2



# 400

HØJDE 400 mm	LÆNGDE	DYBDE	Varenr./ VVS (V)	Varenr./ VVS(H)	EFFEKT (W) 45/35/20°C	EFFEKT (W) 55/45/20°C	EFFEKT (W) 60/45/20°C	VOLUMEN (l)	N- ekponent	VÆGT (kg)
<b>Type 33</b>										
400	152		328646104		196	345	375	2.7	1.33	13.5
500	152		328646105		245	432	468	3.4	1.33	16.4
600	152		328646106		294	518	562	4.0	1.33	19.2
700	152		328646107		343	604	656	4.7	1.33	22.1
800	152		328646108		392	691	749	5.4	1.33	25.0
900	152		328646109		441	777	843	6.0	1.33	27.9
1000	152		328646110		490	863	937	6.7	1.33	3.8
1100	152		328646111		539	950	1031	7.4	1.33	33.6
1200	152		328646112		588	1036	1124	8.0	1.33	36.5
1400	152		328646114		686	1209	1312	9.4	1.33	42.3
1600	152		328646116		785	1381	1499	10.7	1.33	48.5
1800	152		328646118		883	1554	1686	12.1	1.33	53.9
2000	152		328646120		981	1726	1874	13.4	1.33	59.6
2300	152		328646123		1128	1985	2155	15.4	1.33	68.2
2600	152		328646126		1275	2244	2436	17.4	1.33	76.9
3000	152		328646130		1471	2590	2811	20.1	1.33	88.4



# 450

HØJDE 450 mm	LÆNGDE	DYBDE	Varenr./ VVS (V)	Varenr./ VVS(H)	EFFEKT (W) 45/35/20°C	EFFEKT (W) 55/45/20°C	EFFEKT (W) 60/45/20°C	VOLUMEN (l)	N- ekponent	VÆGT (kg)
<b>Type 11</b>										
400	60		F061104504010H00	328641504	93	162	176	1.0	1.30	6.4
500	60		F061104505010H00	328641505	116	203	220	1.3	1.30	7.6
600	60		F061104506010H00	328641506	139	243	264	1.5	1.30	8.9
700	60		F061104507010H00	328641507	163	284	308	1.8	1.30	12
800	60		F061104508010H00	328641508	186	325	352	2.0	1.30	11.4
900	60		F061104509010H00	328641509	209	365	396	2.3	1.30	12.7
1000	60		F061104510010H00	328641510	232	406	440	2.5	1.30	14.0
1100	60		F061104511010H00	328641511	256	446	484	2.8	1.30	15.2
1200	60		F061104512010H00	328641512	279	487	528	3.0	1.30	16.5
1400	60		F061104514010H00	328641514	325	568	616	3.5	1.30	19.4
1600	60		F061104516010H00	328641516	372	649	704,703	4.0	1.30	21.5
1800	60		F061104518010H00	328641518	418	730	792,791	4.5	1.30	24.5
2000	60		F061104520010H00	328641520	465	811	880,879	5.0	1.30	26.6
2300	60		F061104523010H00	328641523	535	933	1011	5.8	1.30	34
2600	60		F061104526010H00	328641526	604	1055	1143	6.5	1.30	34.2
3000	60		F061104530010H00	328641530	697	1217	1319	7.5	1.30	39.2
<b>Type 21</b>										
400	70		F062104504010H00	328643504	125	218	236	2.0	1.30	9.3
500	70		F062104505010H00	328643505	157	273	296	2.5	1.30	11.3
600	70		F062104506010H00	328643506	188	327	355	3.0	1.30	13.4
700	70		F062104507010H00	328643507	219	382	414	3.5	1.30	15.4
800	70		F062104508010H00	328643508	250	436	473	4.0	1.30	17.4
900	70		F062104509010H00	328643509	282	491	532	4.5	1.30	19.4
1000	70		F062104510010H00	328643510	313	545	591	5.0	1.30	21.4
1100	70		F062104511010H00	328643511	344	600	650	5.5	1.30	23.5



## 450

HØJDE 450 mm	LÆNGDE	DYBDE	Varenr./ VVS (V)	Varenr./ VVS(H)	EFFEKT (W) 45/35/20°C	EFFEKT (W) 55/45/20°C	EFFEKT (W) 60/45/20°C	VOLUMEN (l)	N- ekponent	VÆGT (kg)
	1200	70	F062104512010H00	328643512	376	654	709	6.0	1.30	25.5
	1400	70	F062104514010H00	328643514	438	764	828,827	7.0	1.30	29.5
	1600	70	F062104516010H00	328643516	501	873	946	8.0	1.30	33.6
	1800	70	F062104518010H00	328643518	564,563	982	1064	9.0	1.30	37.7
	2000	70	F062104520010H00	328643520	626	1091	1182	10.0	1.30	41.6
	2300	70	F062104523010H00	328643523	720	1254	1360,1359	11.5	1.30	47.7
	2600	70	F062104526010H00	328643526	814	1418	1537	13.0	1.30	53.8
	3000	70	F062104530010H00	328643530	939	1636	1773	15.0	1.30	61.9
<b>Type 22</b>										
	400	102	328644504		156	274	297	2.0	1.32	1.6
	500	102	328644505		195	343	372	2.5	1.32	13.0
	600	102	328644506		234	411	446	3.0	1.32	15.3
	700	102	328644507		273	480	521	3.5	1.32	17.6
	800	102	328644508		312	548	595	4.0	1.32	19.9
	900	102	328644509		351	617	669	4.5	1.32	22.2
	1000	102	328644510		390	685	744	5.0	1.32	24.5
	1100	102	328644511		429	754	818	5.5	1.32	26.8
	1200	102	328644512		468	822	892	6.0	1.32	29.1
	1400	102	328644514		546	960	1041	7.0	1.32	33.7
	1500	102	328644515		585	1028	--	7.5	1.32	36.3
	1600	102	328644516		624	1097	1190	8.0	1.32	38.3
	1800	102	328644518		702	1234	1339	9.0	1.32	43.0
	2000	102	328644520		780	1371	1487	10.0	1.32	47.6
	2300	102	328644523		897	1576	1711	11.5	1.32	54.5
	2600	102	328644526		1014	1782	1934	13.0	1.32	61.4
	3000	102	328644530		1169	2056	2231	15.0	1.32	7.6



# 450

HØJDE 450 mm	LÆNGDE	DYBDE	Varenr./ VVS (V)	Varenr./ VVS(H)	EFFEKT (W) 45/35/20°C	EFFEKT (W) 55/45/20°C	EFFEKT (W) 60/45/20°C	VOLUMEN (l)	N- ekponent	VÆGT (kg)
<b>Type 33</b>										
400	152		328646504		215	379	411	3.0	1.33	15.8
500	152		328646505		268	473	514	3.8	1.33	19.2
600	152		328646506		322	568	617	4.5	1.33	22.7
700	152		328646507		376	663	720	5.3	1.33	26.1
800	152		328646508		429	757	822	6.0	1.33	29.6
900	152		328646509		483	852	925	6.8	1.33	33.7
1000	152		328646510		536	947	1028	7.5	1.33	36.5
1100	152		328646511		590	1041	1131	8.3	1.33	39.9
1200	152		328646512		644	1136	1233	9.0	1.33	43.3
1400	152		328646514		751	1326	1439	10.5	1.33	5.2
1600	152		328646516		858	1515	1645	12.0	1.33	57.1
1800	152		328646518		966	1704	1850	13.5	1.33	64.1
2000	152		328646520		1073	1894	2056	15.0	1.33	7.9
2300	152		328646523		1234	2178	2364	17.3	1.33	81.2
2600	152		328646526		1395	2462	2673	19.5	1.33	91.6
3000	152		328646530		1609	2840	3084	22.5	1.33	107.4



# 500

HØJDE 500 mm	LÆNGDE	DYBDE	Varenr./ VVS (V)	Varenr./ VVS(H)	EFFEKT (W) 45/35/20°C	EFFEKT (W) 55/45/20°C	EFFEKT (W) 60/45/20°C	VOLUMEN (l)	N- ekponent	VÆGT (kg)
<b>Type 11</b>										
400	60		F061105004010H00	328651104	102	178	193	1.1	1.31	6.5
500	60		F061105005010H00	328651105	127	223	241	1.4	1.31	7.8
600	60		F061105006010H00	328651106	153	267	290	1.6	1.31	9.2
700	60		F061105007010H00	328651107	178	312	338	1.9	1.31	16
800	60		F061105008010H00	328651108	204	356	386	2.2	1.31	12.0
900	60		F061105009010H00	328651109	229	401	434	2.4	1.31	13.3
1000	60		F061105010010H00	328651110	255	445	483	2.7	1.31	14.8
1100	60		F061105011010H00	328651111	280	490	531	3.0	1.31	16.4
1200	60		F061105012010H00	328651112	306	534	579	3.2	1.31	17.5
1400	60		F061105014010H00	328651114	357	623	676	3.8	1.31	2.2
1600	60		F061105016010H00	328651116	408	712	772	4.3	1.31	22.9
1800	60		F061105018010H00	328651118	459	801	869	4.9	1.31	25.7
2000	60		F061105020010H00	328651120	510	890	965	5.4	1.31	28.4
2300	60		F061105023010H00	328651123	586	1024	1110	6.2	1.31	32.6
2600	60		F061105026010H00	328651126	663	1158	1255	7.0	1.31	36.7
3000	60		F061105030010H00	328651130	765,764	1336	1448	8.1	1.31	43.0
<b>Type 21</b>										
400	70		F062105004010H00	328653104	136	237	257	2.2	1.31	9.6
500	70		F062105005010H00	328653105	170	296	321	2.8	1.31	11.7
600	70		F062105006010H00	328653106	204	356	386	3.3	1.31	13.8
700	70		F062105007010H00	328653107	237	415	450	3.9	1.31	15.9
800	70		F062105008010H00	328653108	271	474	514	4.4	1.31	18.1
900	70		F062105009010H00	328653109	305	533	578	5.0	1.31	2.1
1000	70		F062105010010H00	328653110	339	593	643	5.5	1.31	22.2
1100	70		F062105011010H00	328653111	373	652	707	6.0	1.31	24.3



# 500

HØJDE 500 mm	LÆNGDE	DYBDE	Varenr./ VVS (V)	Varenr./ VVS(H)	EFFEKT (W) 45/35/20°C	EFFEKT (W) 55/45/20°C	EFFEKT (W) 60/45/20°C	VOLUMEN (l)	N- ekponent	VÆGT (kg)
	1200	70	F062105012010H00	328653112	407	711	771	6.6	1.31	26.4
	1400	70	F062105014010H00	328653114	475	830	900	7.7	1.31	3.5
	1600	70	F062105016010H00	328653116	543	948	1029,1028	8.8	1.31	34.7
	1800	70	F062105018010H00	328653118	611	1067	1157	9.9	1.31	38.9
	2000	70	F062105020010H00	328653120	679,678	1185	1285	11.0	1.31	43.9
	2300	70	F062105023010H00	328653123	780	1363	1478	12.7	1.31	49.4
	2600	70	F062105026010H00	328653126	882	1541	1671	14.3	1.31	55.6
	3000	70	F062105030010H00	328653130	1018	1778	1928	16.5	1.31	64.0
<b>Type 22</b>										
	400	102	328654104		169	299	324	2.2	1.33	11.2
	500	102	328654105		212	373	405	2.8	1.33	13.7
	600	102	328654106		254	448	486	3.3	1.33	16.4
	700	102	328654107		297	522	567	3.9	1.33	18.6
	800	102	328654108		339	597	648	4.4	1.33	2.9
	900	102	328654109		381	672	729	5.0	1.33	23.4
	1000	102	328654110		424	746	810	5.5	1.33	25.8
	1100	102	328654111		466	821	891	6.0	1.33	28.3
	1200	102	328654112		508	896	972	6.6	1.33	3.6
	1400	102	328654114		593	1045	1134	7.7	1.33	35.5
	1500	102	328654115		635	1119	--	8.3	1.33	37.9
	1600	102	328654116		678	1194	1296	8.8	1.33	4.3
	1800	102	328654118		763	1343	1458	9.9	1.33	45.2
	2000	102	328654120		847	1493	1620	11.0	1.33	5.1
	2300	102	328654123		974	1717	1863	12.7	1.33	57.3
	2600	102	328654126		1102	1940	2106	14.3	1.33	64.6
	3000	102	328654130		1271	2239	2430	16.5	1.33	74.3



# 500

HØJDE 500 mm	LÆNGDE	DYBDE	Varenr./ VVS (V)	Varenr./ VVS(H)	EFFEKT (W) 45/35/20°C	EFFEKT (W) 55/45/20°C	EFFEKT (W) 60/45/20°C	VOLUMEN (l)	N- ekponent	VÆGT (kg)
<b>Type 33</b>										
400	152		328656104		232	411	447	3.3	1.34	16.6
500	152		328656105		290	514	558	4.1	1.34	2.2
600	152		328656106		349	617	670	4.9	1.34	23.9
700	152		328656107		407	719	781	5.7	1.34	27.6
800	152		328656108		465	822	893	6.6	1.34	31.1
900	152		328656109		523	925	1005	7.4	1.34	34.8
1000	152		328656110		581	1028	1116	8.2	1.34	38.5
1100	152		328656111		639	1131	1228	9.0	1.34	42.4
1200	152		328656112		697	1233	1340	9.8	1.34	45.7
1400	152		328656114		813	1439	1563	11.5	1.34	52.9
1600	152		328656116		930	1645	1786	13.1	1.34	6.2
1800	152		328656118		1046	1850	2009	14.8	1.34	67.5
2000	152		328656120		1162	2056	2233	16.4	1.34	74.7
2300	152		328656123		1336	2364	2567	18.9	1.34	85.6
2600	152		328656126		1511	2672	2902	21.3	1.34	96.6
3000	152		328656130		1743	3084	3349	24.6	1.34	111.9



## 550

HØJDE 550 mm	LÆNGDE	DYBDE	Varenr./ VVS	EFFEKT (W) 45/35/20°C	EFFEKT (W) 55/45/20°C	EFFEKT (W) 60/45/20°C	VOLUMEN (l)	N- ekponent	VÆGT (kg)
<b>Type 11</b>									
	400	60	F061105504010300	111	193	210	1.2	1.31	7.3
	500	60	F061105505010300	138	242	262	1.5	1.31	8.8
	600	60	F061105506010300	166	290	315	1.8	1.31	1.2
	700	60	F061105507010300	194	339	367	2.1	1.31	11.8
	800	60	F061105508010300	221	387	419	2.4	1.31	13.2
	900	60	F061105509010300	249	435	472	2.7	1.31	14.7
	1000	60	F061105510010300	277	484	524	3.0	1.31	16.1
	1100	60	F061105511010300	304	532	577	3.3	1.31	17.6
	1200	60	F061105512010300	332	580	629	3.6	1.31	19.1
	1400	60	F061105514010300	387	677	734	4.2	1.31	22.5
	1600	60	F061105516010300	443	774	839	4.8	1.31	25.5
	1800	60	F061105518010300	498	871	944	5.4	1.31	28.0
	2000	60	F061105520010300	553	967	1049	6.0	1.31	3.9
	2300	60	F061105523010300	636	1112	1206	6.9	1.31	35.3
	2600	60	F061105526010300	719	1257	1363	7.8	1.31	39.8
	3000	60	F061105530010300	830	1451	1573	9.0	1.31	45.7
<b>Type 21</b>									
	400	70	F062105504010300	146	255	277	2.4	1.31	1.4
	500	70	F062105505010300	182	319	346	3.0	1.31	12.8
	600	70	F062105506010300	219	383	415	3.7	1.31	15.3
	700	70	F062105507010300	255	447	484	4.3	1.31	17.7
	800	70	F062105508010300	291	511	554	4.9	1.31	2.2
	900	70	F062105509010300	328	574	623	5.5	1.31	22.6
	1000	70	F062105510010300	364	638	692	6.1	1.31	25.6
	1100	70	F062105511010300	401	702	761	6.7	1.31	27.5



# 550

HØJDE 550 mm	LÆNGDE	DYBDE	Varenr./ VVS	EFFEKT (W) 45/35/20°C	EFFEKT (W) 55/45/20°C	EFFEKT (W) 60/45/20°C	VOLUMEN (l)	N- ekponent	VÆGT (kg)
	1200	70	F062105512010300	437	766	831	7.3	1.31	30.0
	1400	70	F062105514010300	510	893	969	8.5	1.31	34.9
	1600	70	F062105516010300	583	1021	1107	9.8	1.31	39.8
	1800	70	F062105518010300	656	1149	1246	11.0	1.31	44.7
	2000	70	F062105520010300	728	1276	1384	12.2	1.31	49.6
	2300	70	F062105523010300	838	1468	1592	14.0	1.31	56.9
	2600	70	F062105526010300	947	1659	1799	15.9	1.31	64.3
	3000	70	F062105530010300	1093	1915	2076	18.3	1.31	74.9
<b>Type 22</b>									
	400	102	F062205504010300	183	322	350	2.4	1.33	12.2
	500	102	F062205505010300	228	403	437	3.0	1.33	14.9
	600	102	F062205506010300	274	484	525	3.7	1.33	17.8
	700	102	F062205507010300	320	564	612	4.3	1.33	2.5
	800	102	F062205508010300	365	645	700	4.9	1.33	23.2
	900	102	F062205509010300	411	725	787	5.5	1.33	26.0
	1000	102	F062205510010300	457	806	875	6.1	1.33	28.7
	1100	102	F062205511010300	502	887	962	6.7	1.33	31.5
	1200	102	F062205512010300	548	967	1050	7.3	1.33	34.3
	1400	102	F062205514010300	639	1128	1225	8.5	1.33	39.8
	1600	102	F062205516010300	731	1289	1400	9.8	1.33	45.3
	1800	102	F062205518010300	822	1451	1575	11.0	1.33	5.8
	2000	102	F062205520010300	913	1612	1750	12.2	1.33	56.3
	2300	102	F062205523010300	1050	1854	2012	14.0	1.33	64.6
	2600	102	F062205526010300	1187	2095	2275	15.9	1.33	72.9
	3000	102	F062205530010300	1370	2418	2625	18.3	1.33	83.9

**Type 33**



# 550

HØJDE 550 mm	LÆNGDE	DYBDE	Varenr./ VVS	EFFEKT (W) 45/35/20°C	EFFEKT (W) 55/45/20°C	EFFEKT (W) 60/45/20°C	VOLUMEN (l)	N- ekponent	VÆGT (kg)
	400	152	F063305504010300	250	443	481	3.6	1.34	18.0
	500	152	F063305505010300	312	553	601	4.5	1.34	22.2
	600	152	F063305506010300	374	664	721	5.4	1.34	26.6
	700	152	F063305507010300	437	775	841	6.3	1.34	31
	800	152	F063305508010300	499	885	962	7.2	1.34	34.2
	900	152	F063305509010300	561	996	1082	8.1	1.34	38.3
	1000	152	F063305510010300	624	1106	1202	9.0	1.34	42.3
	1100	152	F063305511010300	686	1217	1322	9.9	1.34	46.4
	1200	152	F063305512010300	749	1328	1442	10.8	1.34	5.5
	1400	152	F063305514010300	873	1549	1683	12.6	1.34	58.6
	1600	152	F063305516010300	998	1770	1923	14.4	1.34	66.7
	1800	152	F063305518010300	1123	1992	2164	16.2	1.34	74.8
	2000	152	F063305520010300	1248	2213	2404	18.0	1.34	83.0
	2300	152	F063305523010300	1435	2545	2765	20.7	1.34	95.2
	2600	152	F063305526010300	1622	2877	3125	23.4	1.34	109.4
	3000	152	F063305530010300	1872	3319	3606	27.0	1.34	123.6



# 600

HØJDE 600 mm	LÆNGDE	DYBDE	Varenr./ VVS (V)	Varenr./ VVS(H)	EFFEKT (W) 45/35/20°C	EFFEKT (W) 55/45/20°C	EFFEKT (W) 60/45/20°C	VOLUMEN (l)	N- ekponent	VÆGT (kg)
<b>Type 11</b>										
400	60		F061106004010H00	328661104	119	208	226	1.3	1.31	7.9
500	60		F061106005010H00	328661105	149	260	282	1.6	1.31	9.5
600	60		F061106006010H00	328661106	179	313	339	1.9	1.31	11.1
700	60		F061106007010H00	328661107	208	365	396,395	2.2	1.31	12.7
800	60		F061106008010H00	328661108	238	417	452	2.6	1.31	14.4
900	60		F061106009010H00	328661109	268	469	508	2.9	1.31	16.0
1000	60		F061106010010H00	328661110	298	521	565	3.2	1.31	17.6
1100	60		F061106011010H00	328661111	327	573	622,621	3.5	1.31	19.2
1200	60		F061106012010H00	328661112	357	625	678	3.8	1.31	2.9
1400	60		F061106014010H00	328661114	417	729	791	4.5	1.31	24.4
1600	60		F061106016010H00	328661116	476	834	904	5.1	1.31	27.3
1800	60		F061106018010H00	328661118	536	938	1017	5.8	1.31	3.5
2000	60		F061106020010H00	328661120	595	1042	1130	6.4	1.31	33.7
2300	60		F061106023010H00	328661123	685,684	1198	1299	7.4	1.31	38.6
2600	60		F061106026010H00	328661126	774	1354	1469	8.3	1.31	43.4
3000	60		F061106030010H00	328661130	893	1563	1695	9.6	1.31	49.8
<b>Type 21</b>										
400	70		F062106004010H00	328663104	155	273	296	2.6	1.32	11.5
500	70		F062106005010H00	328663105	194	341	370	3.3	1.32	14.4
600	70		F062106006010H00	328663106	233	409	444	4.0	1.32	16.6
700	70		F062106007010H00	328663107	272	478	518	4.6	1.32	19.2
800	70		F062106008010H00	328663108	311	546	592	5.3	1.32	21.7
900	70		F062106009010H00	328663109	349	614	666	5.9	1.32	24.3
1000	70		F062106010010H00	328663110	388	682	740	6.6	1.32	26.8
1100	70		F062106011010H00	328663111	427	751	814	7.3	1.32	29.4



# 600

HØJDE 600 mm	LÆNGDE	DYBDE	Varenr./ VVS (V)	Varenr./ VVS(H)	EFFEKT (W) 45/35/20°C	EFFEKT (W) 55/45/20°C	EFFEKT (W) 60/45/20°C	VOLUMEN (l)	N- ekponent	VÆGT (kg)
	1200	70	F062106012010H00	328663112	466	819	889,888	7.9	1.32	31.9
	1400	70	F062106014010H00	328663114	544,543	955	1037,1036	9.2	1.32	37.3
	1600	70	F062106016010H00	328663116	621	1092	1185,1184	10.6	1.32	42.1
	1800	70	F062106018010H00	328663118	699	1228	1333,1332	11.9	1.32	47.2
	2000	70	F062106020010H00	328663120	777,776	1365	1481	13.2	1.32	52.3
	2300	70	F062106023010H00	328663123	893	1569	1703	15.2	1.32	60.0
	2600	70	F062106026010H00	328663126	1009	1774	1925	17.2	1.32	67.6
	3000	70	F062106030010H00	328663130	1165,1164	2047	2221	19.8	1.32	77.8
<b>Type 22</b>										
	400	102	328664104		195	346	375	2.6	1.34	13.8
	500	102	328664105		244	432	469	3.3	1.34	16.8
	600	102	328664106		293	518	563	4.0	1.34	19.6
	700	102	328664107		342	605	657	4.6	1.34	22.6
	800	102	328664108		391	691	750	5.3	1.34	25.5
	900	102	328664109		440	777	844	5.9	1.34	28.4
	1000	102	328664110		488	864	938	6.6	1.34	31.4
	1100	102	328664111		537	950	1032	7.3	1.34	34.3
	1200	102	328664112		586	1037	1126	7.9	1.34	37.2
	1400	102	328664114		684	1209	1313	9.2	1.34	43.9
	1500	102	328664115		733	1296	--	9.9	1.34	46.2
	1600	102	328664116		782	1382	1501	10.6	1.34	49.0
	1800	102	328664118		879	1555	1688	11.9	1.34	54.9
	2000	102	328664120		977	1728	1876	13.2	1.34	6.7
	2300	102	328664123		1124	1987	2157	15.2	1.34	69.5
	2600	102	328664126		1270	2246	2439	17.2	1.34	78.3
	3000	102	328664130		1465	2591	2814	19.8	1.34	90.0



# 600

HØJDE 600 mm	LÆNGDE	DYBDE	Varenr./ VVS (V)	Varenr./ VVS(H)	EFFEKT (W) 45/35/20°C	EFFEKT (W) 55/45/20°C	EFFEKT (W) 60/45/20°C	VOLUMEN (l)	N- ekponent	VÆGT (kg)
<b>Type 33</b>										
400	152		328666104		266	473	514	3.9	1.35	2.8
500	152		328666105		333	592	643	4.9	1.35	24.5
600	152		328666106		399	710	771	5.9	1.35	28.9
700	152		328666107		466	828	900	6.9	1.35	33.3
800	152		328666108		532	946	1029	7.8	1.35	37.6
900	152		328666109		599	1065	1157	8.8	1.35	42.2
1000	152		328666110		665	1183	1286	9.8	1.35	46.4
1100	152		328666111		732	1301	1414	10.8	1.35	5.9
1200	152		328666112		798	1420	1543	11.8	1.35	55.2
1400	152		328666114		932	1656	1800	13.7	1.35	64.0
1600	152		328666116		1065	1893	2057	15.7	1.35	72.8
1800	152		328666118		1198	2129	2314	17.6	1.35	81.5
2000	152		328666120		1331	2366	2571	19.6	1.35	9.4
2300	152		328666123		1530	2721	2957	22.5	1.35	105.5
2600	152		328666126		1730	3076	3343	25.5	1.35	116.7
3000	152		328666130		1996	3549	3857	29.4	1.35	134.3



# 900

HØJDE 900 mm	LÆNGDE	DYBDE	Varenr./ VVS (V)	Varenr./ VVS(H)	EFFEKT (W) 45/35/20°C	EFFEKT (W) 55/45/20°C	EFFEKT (W) 60/45/20°C	VOLUMEN (l)	N- ekponent	VÆGT (kg)
<b>Type 11</b>										
400	60		F061109004010H00	328691104	166	291	316	1.8	1.32	11.9
500	60		F061109005010H00	328691105	208	364	395	2.3	1.32	14.3
600	60		F061109006010H00	328691106	249	437	474	2.7	1.32	16.8
700	60		F061109007010H00	328691107	291	510	553	3.1	1.32	19.2
800	60		F061109008010H00	328691108	332	583	632	3.6	1.32	21.7
900	60		F061109009010H00	328691109	374,373	655	711	4.0	1.32	24.2
1000	60		F061109010010H00	328691110	415	728	790	4.5	1.32	26.7
1100	60		F061109011010H00	328691111	457	801	869	5.0	1.32	29.2
1200	60		F061109012010H00	328691112	498	874	948	5.4	1.32	31.6
1400	60		F061109014010H00	328691114	581	1019	1106	6.3	1.32	36.6
1600	60		F061109016010H00	328691116	664	1165	1264	7.2	1.32	41.6
1800	60		F061109018010H00	328691118	747	1311	1422	8.1	1.32	46.5
2000	60		F061109020010H00	328691120	830	1456	1580	9.0	1.32	51.5
2300	60		F061109023010H00	328691123	955	1675	1817	10.3	1.32	58.9
2600	60		F061109026010H00	328691126	1079	1893	2054	11.7	1.32	66.4
3000	60		F061109030010H00	328691130	1245	2185	2370	13.5	1.32	76.3
<b>Type 21</b>										
400	70		F062109004010H00	328693104	212	376	408	3.6	1.34	16.7
500	70		F062109005010H00	328693105	265	470	510	4.5	1.34	2.6
600	70		F062109006010H00	328693106	318	563	612	5.4	1.34	24.3
700	70		F062109007010H00	328693107	371	657	714	6.3	1.34	28.6
800	70		F062109008010H00	328693108	424	751	816	7.2	1.34	31.8
900	70		F062109009010H00	328693109	477	845	918	8.1	1.34	35.6
1000	70		F062109010010H00	328693110	530	939	1020	9.0	1.34	39.5
1100	70		F062109011010H00	328693111	583	1033	1122	9.9	1.34	43.2



# 900

HØJDE 900 mm	LÆNGDE	DYBDE	Varenr./ VVS (V)	Varenr./ VVS(H)	EFFEKT (W) 45/35/20°C	EFFEKT (W) 55/45/20°C	EFFEKT (W) 60/45/20°C	VOLUMEN (l)	N- ekponent	VÆGT (kg)
	1200	70	F062109012010H00	328693112	636	1127	1224	10.8	1.34	47.0
	1400	70	F062109014010H00	328693114	742	1315	1428	12.6	1.34	54.5
	1600	70	F062109016010H00	328693116	849,848	1502	1632	14.4	1.34	62.8
	1800	70	F062109018010H00	328693118	955,954	1690	1836	16.2	1.34	69.6
	2000	70	F062109020010H00	328693120	1061,1060	1878	2040	18.0	1.34	77.2
	2300	70	F062109023010H00	328693123	1220,1219	2160	2346	20.7	1.34	88.5
	2600	70	F062109026010H00	328693126	1379	2442	2653,2652	23.4	1.34	101.8
	3000	70	F062109030010H00	328693130	1591	2817	3060	27.0	1.34	115.0
<b>Type 22</b>										
	400	102	328694104		268	478	520	3.6	1.36	19.8
	500	102	328694105		335	597	649	4.5	1.36	24.2
	600	102	328694106		402	717	779	5.4	1.36	28.7
	700	102	328694107		469	836	909	6.3	1.36	33.2
	800	102	328694108		536	956	1039	7.2	1.36	37.7
	900	102	328694109		603	1075	1169	8.1	1.36	42.2
	1000	102	328694110		670	1194	1299	9.0	1.36	46.7
	1100	102	328694111		737	1314	1429	9.9	1.36	51.2
	1200	102	328694112		804	1433	1559	10.8	1.36	55.7
	1400	102	328694114		938	1672	1818	12.6	1.36	64.7
	1500	102	328694115		1005	1792	--	13.5	1.36	69.2
	1600	102	328694116		1072	1911	2078	14.4	1.36	73.7
	1800	102	328694118		1205	2150	2338	16.2	1.36	82.7
	2000	102	328694120		1339	2389	2598	18.0	1.36	91.6
	2300	102	328694123		1540	2747	2987	20.7	1.36	107.2
	2600	102	328694126		1741	3106	3377	23.4	1.36	118.7
	3000	102	328694130		2009	3583	3896	27.0	1.36	136.6



# 900

HØJDE 900 mm	LÆNGDE	DYBDE	Varenr./ VVS (V)	Varenr./ VVS(H)	EFFEKT (W) 45/35/20°C	EFFEKT (W) 55/45/20°C	EFFEKT (W) 60/45/20°C	VOLUMEN (l)	N- ekponent	VÆGT (kg)
<b>Type 33</b>										
400	152		328696104		364	651	708	5.3	1.36	28.7
500	152		328696105		455	814	885	6.7	1.36	35.4
600	152		328696106		547	976	1062	8.0	1.36	42.9
700	152		328696107		638	1139	1239	9.3	1.36	48.8
800	152		328696108		729	1302	1416	10.6	1.36	55.5
900	152		328696109		820	1465	1593	12.0	1.36	62.3
1000	152		328696110		911	1627	1770	13.0	1.36	69.0
1100	152		328696111		1002	1790	1947	14.6	1.36	75.6
1200	152		328696112		1093	1953	2124	16.0	1.36	82.0
1400	152		328696114		1275	2278	2478	19.0	1.36	96.0
1600	152		328696116		1457	2604	2832	21.3	1.36	111.3
1800	152		328696118		1640	2929	3186	23.9	1.36	122.6
2000	152		328696120		1822	3255	3540	26.6	1.36	136.0
2300	152		328696123		2095	3743	4071	30.6	1.36	156.8
2600	152		328696126		2368	4231	4602	34.6	1.36	176.2
3000	152		328696130		2733	4882	5310	39.9	1.36	207.0