



Datablad

2026-06-07

Thermopanel V4

Ger effektiva och flexibla värmelösningar.



- ✓ Dold V4-anslutning
- ✓ Levereras komplett från fabrik
- ✓ Bakåtkompatibel – perfekt för renovering
- ✓ EPD
- ✓ Ventilinsatsen Flamingo är justerbar från 6-165 l/h

Thermopanel V4 är optimerad för flexibilitet och modern estetik med inbyggt V4-koppling. Alla våra panelradiatorer har EPD-certifiering. Leveransinnehåll: * Ventilinsats FLA (integrerad) * Plugg och luftskruv (monterat) * Monclackkonsoler (För vägg ingår förutom till höjd 200mm, där måste golv- eller väggmontage specificeras) * Sidopaneler och toppgaller (monterat) Anslutning: * M22x1,5 c/c 40 botten och sida (V4). Rekommenderade tillbehör: * H-stycke med avstängning * Evosense termostat * TP Flexfördelare * RAK4 Övrigt: Typ 21 och 22 är vändbara. Typ 11 och 33 anges som höger- eller vänsterställd. För områden med hög fuktighet finns galvaniserade modeller tillgängliga på begäran.



Användningsområde

Thermopanel V4 är utformad för bostäder, kommersiella och offentliga byggnader som kräver effektiv uppvärmning. Perfekt för låga fönster, den har en justerbar Flamingo-ventil, dold V4-koppling, flera monteringsalternativ och EPD-certifiering.

Dimensionering

Urvalskriterier inkluderar önskad effekt, dimensioner och monteringspreferenser. För detaljerad vägledning, se vårt beräkningsverktyg eller hitta produkten i Magicloud.

Användning

Thermopanel V4 levereras förmonterad från fabriken. Fäst bara de medföljande konsolerna på väggen, häng upp radiatorn och anslut den till det vattenburna värmesystemet. Den innovativa V4-kopplingen, dold i radiatorn, ger flexibilitet för både botten- och sidanslutningar. Justera Flamingoventilen för optimala flödes hastigheter. Rengör utsidan regelbundet för att bibehålla dess utseende.

AMA Text

PTB.1 Radiatorer

PTB.11 Panelradiatorer

Fabrikat Purmo typ Thermopanel Typ TP V4

Thermopanel typ TP V4 försedd med dolt integrerat

koppel med anslutning i sida och botten, anslutning M22 C/C 40 mm (svensk standard). Radiatorn är försedd med fabriksmonterad Flamingo ventilinsats. Kulör Vit RAL 9016. Levereras med luftningsventil, bottenplugg, sidoplåtar och toppgaller (ej för typ 10, 20, 30) samt omfattande väggkonsoler typ Monclac. Levereras skyddsemballerad och med frontskydd som tas bort i samband med slutrengöring. Installeras med separat avstängningsventil typ SR.

Termostat Evosense med dold maxbegränsning.

TP XX V4 -HLL

XX = Typ 10,11,20,21,22,30, 33-höjd 3-9 (dm) , längd 4-30 (dm)

Kompletterande text

- Förses med TP Rak 4 inkl avstängning i vitt eller kromat utförande (anslutningsventil vid dragning av rör bakom radiator upp till 18 mm)
- Förses med TP-Flex koppel (anslutningskoppel för annan placering av anslutande rör ex mittanslutning, ej höjd 200mm)
- Förses med Quattro 2-rörsfördelare inkl avstängning i vitt- eller kromat utförande. Anslutning cc50 mot anslutande system (anslutningsfördelare för parallellkoppling av flera radiatorer)
- Förses med Dynamisk ventilinsats PR-Q

Tillbehör panelradiatorer

- Golvkonsoler
- Låsbyglar för offentliga lokaler
- Tilluftsdon ThermoAir
- Handduksstång



Specifikationer

EGENSKAPER	ENHET	VÄRDEN
ETIM Class		EC011022
Material		Stål
Typ		11, 21, 22, 33
Ytstruktur		Profilerad
Max arbetstryck	bar	10
Antal standardanslutningar		4
Värmeangivning enligt erkänt EN 442-laboratorium		Ja
Max. driftstemperatur	°C	110
Standardfärg		Ja
Färg		Vit
RAL nummer		9016
Galler/Täckplåt		Ja
Galler/Täckplåt		Ja
Glansvärde		Blank
Gängdimension (tum)		--
Anslutning gänga		Utvändig gänga
Med enpunktsanslutning		Ja
Med luftningsanslutning		Ja
Med luftningsventil/avluftare		Ja
Med avtappningsmöjlighet		Ja



Dokument

DOKUMENT	DOKUMENTTYP	LÄNK
Datablad - Flamingo ventilinsats from. v11 2023	Brochure	https://asset.productmarketingcloud.com/api/assetstorage/3577_85aef21-dbcd-4f7b-9208-71d5e088b167
Datablad Kulörer - Panelradiatorer och Konvektorer	Brochure	https://asset.productmarketingcloud.com/api/assetstorage/3577_68e483fa-ca55-43d0-bcd9-2d8f352bad7b
ROT-Bok	Brochure	https://asset.productmarketingcloud.com/api/assetstorage/3577_efc4ab5e-543f-4cae-af49-3b6f65a3a401
Thermopanel V4 produktkatalog, Upplaga September 2024	Brochure	https://asset.productmarketingcloud.com/api/assetstorage/3577_d61c2089-b9f1-4b81-a91d-798406328fa7
Drift och skötsel Radiatorer och konvektorer	User	https://asset.productmarketingcloud.com/api/assetstorage/3577_bc72a430-42d1-4e59-ae7e-2ad7324d15cd
Användarmanual - Flamingo V2 (FLA)	Installation	https://asset.productmarketingcloud.com/api/assetstorage/3577_d7d4bd99-e485-4573-aeaf-a6fab22b9253
Beräkningsverktyg effekt och flöde - Thermopanel	TechDia	https://asset.productmarketingcloud.com/api/assetstorage/3577_d4a62326-8d70-46b5-8197-89e161a411c4



Resurser



ProductImage - TP-V4-standard_v2-2000x2000px

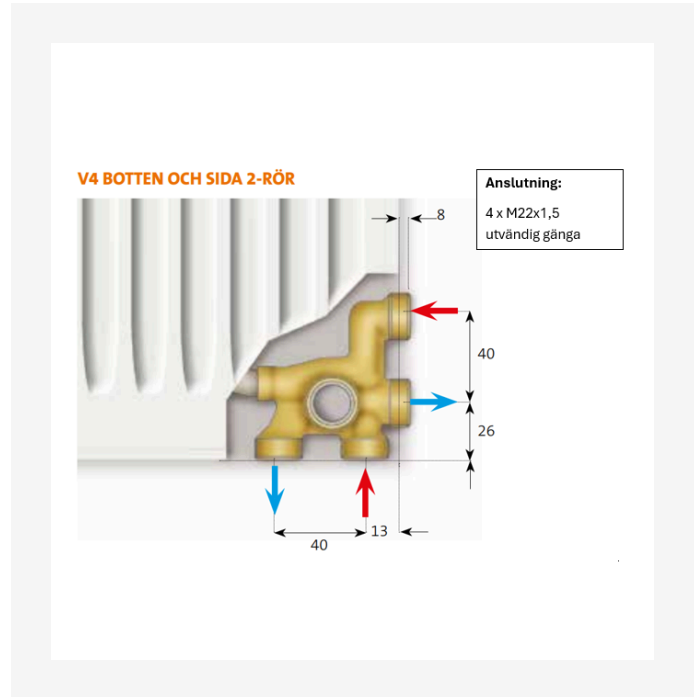

DimensionalDrawing - Thermopanel, V4 koppel anslutningsmått

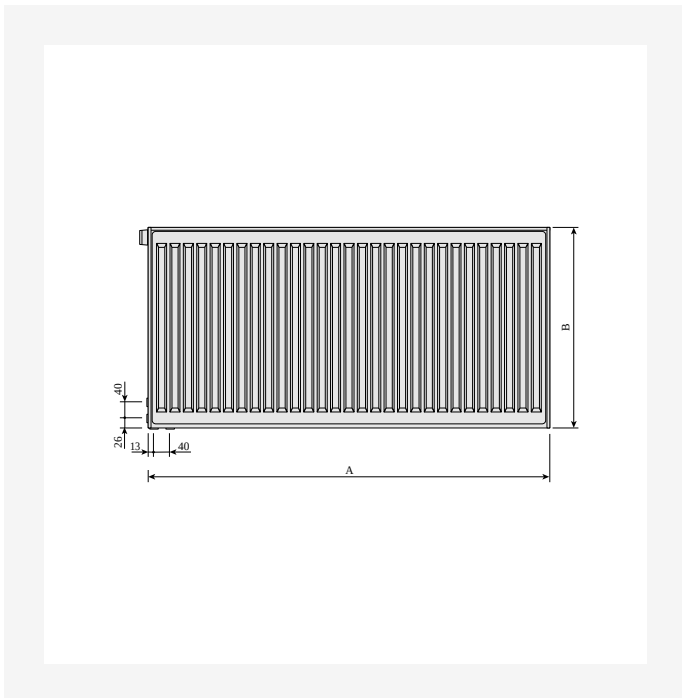

DimensionalDrawing - Thermopanel, vänster fronty

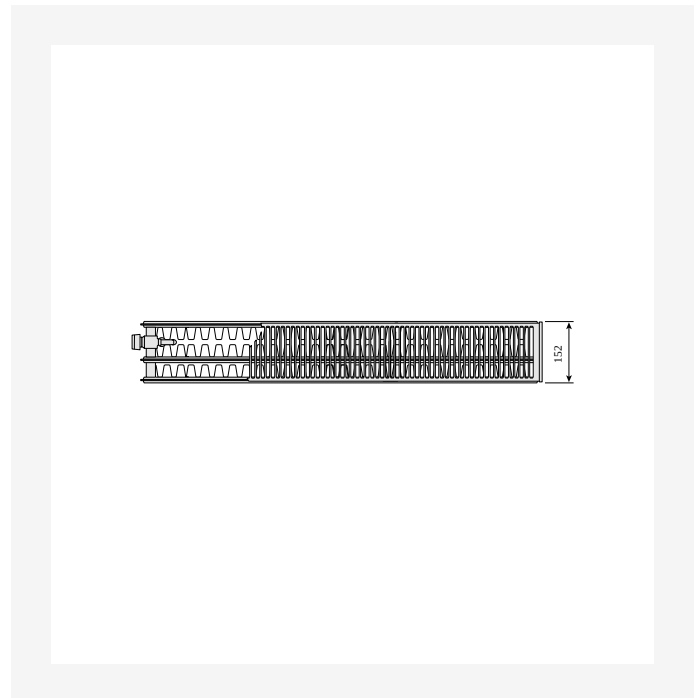

DimensionalDrawing - Thermopanel typ 33, vänster toppvy



Resurser

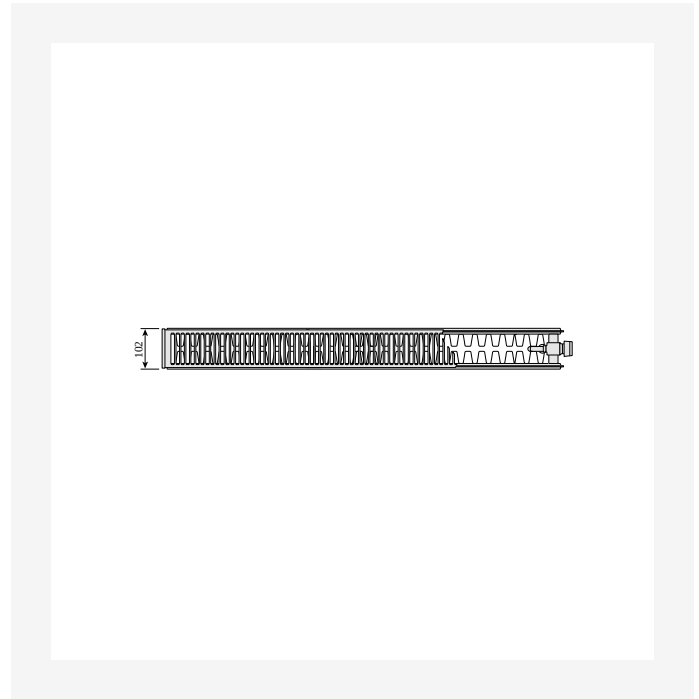
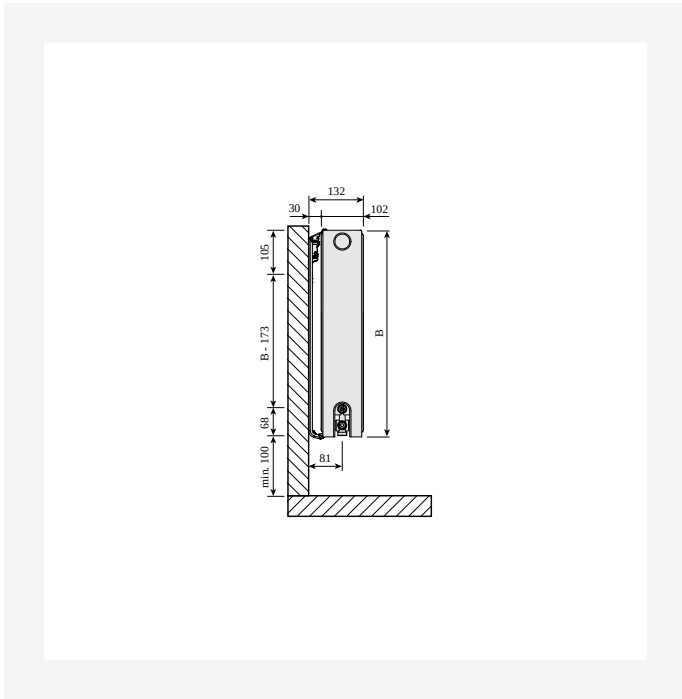

DimensionalDrawing - Thermopanel typ 22, sidovy

DimensionalDrawing - Thermopanel typ 22, toppvy

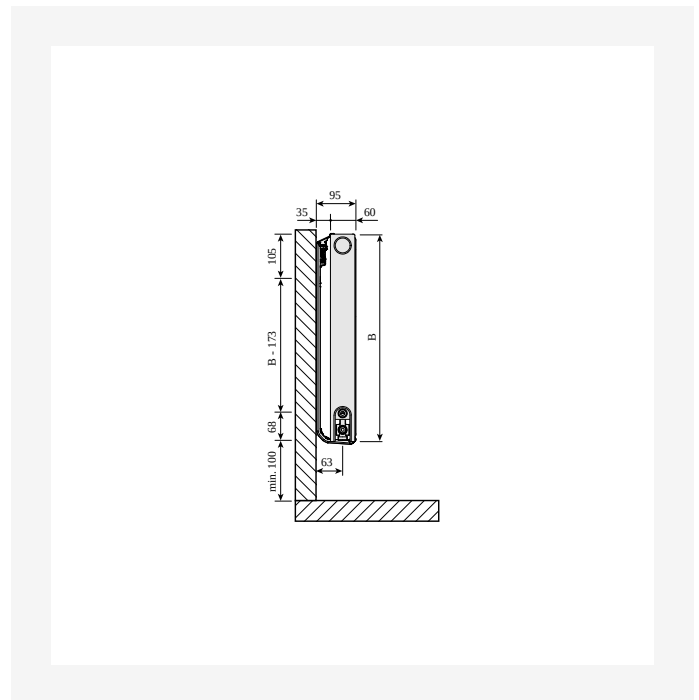
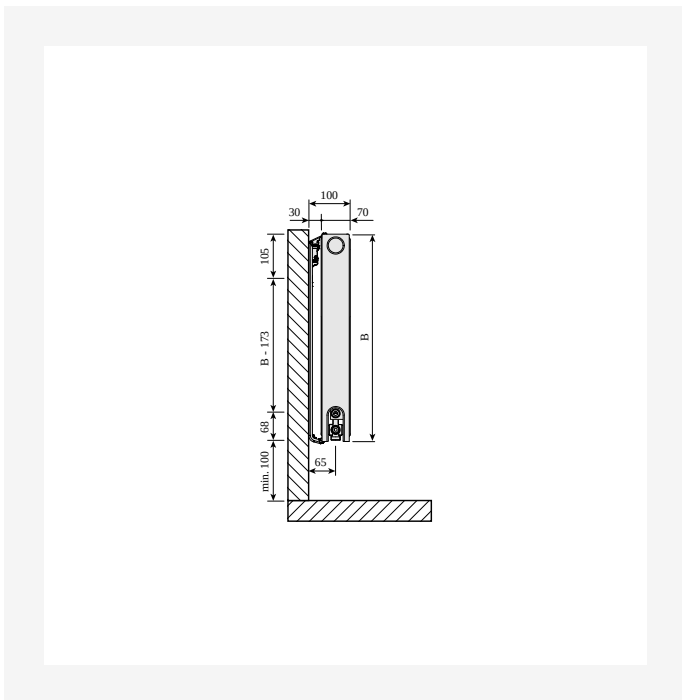

DimensionalDrawing - Thermopanel typ 21, sidovy

DimensionalDrawing - Thermopanel typ 11, sidovy



Resurser

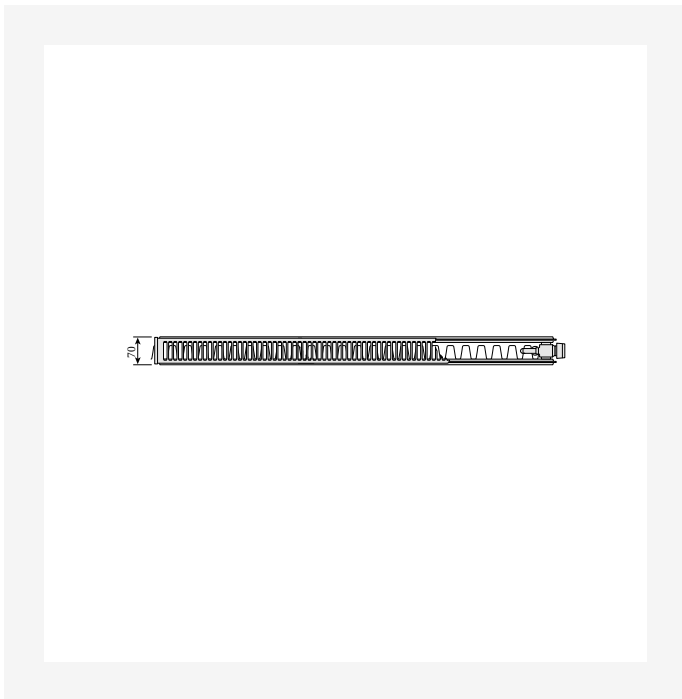

DimensionalDrawing - Thermopanel typ 21, toppvy



DimensionalDrawing - Thermopanel typ 11, höger toppvy

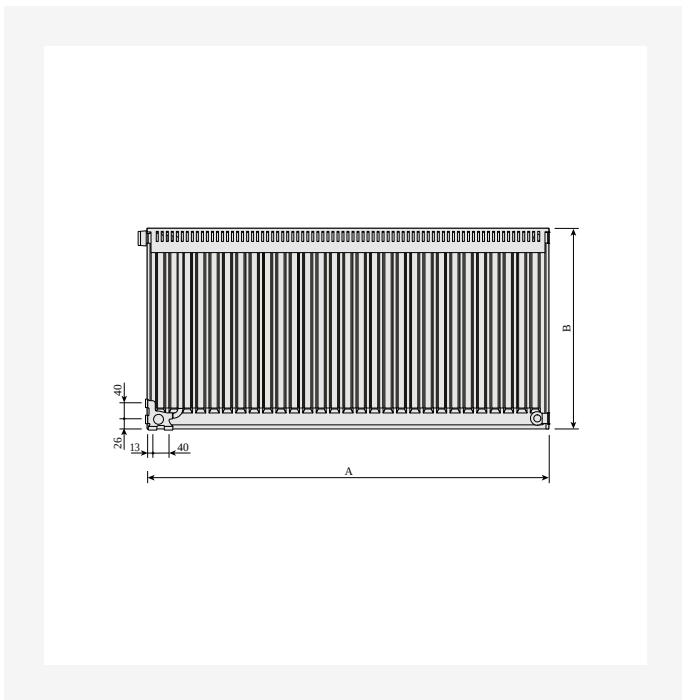

DimensionalDrawing - Thermopanel typ 11, höger baksidesvy



DimensionalDrawing - Thermopanel typ 11, vänster toppvy



Resurser

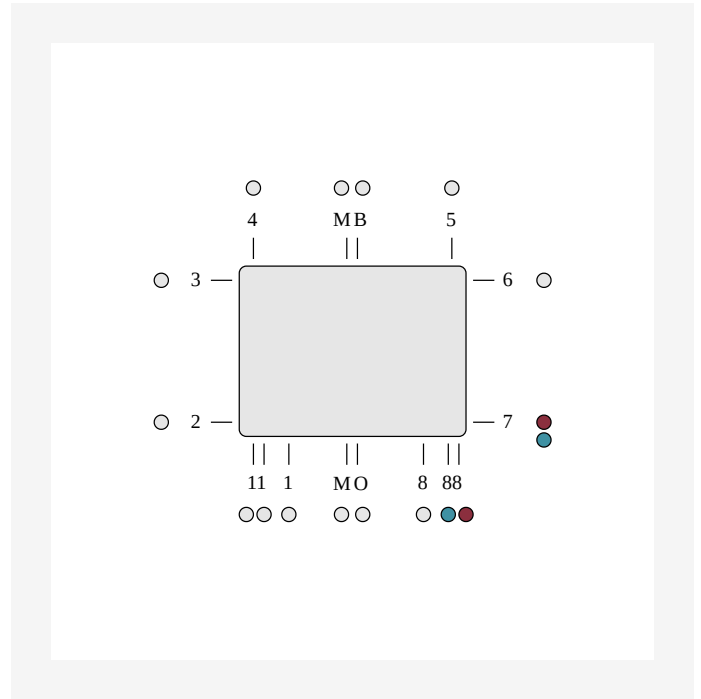
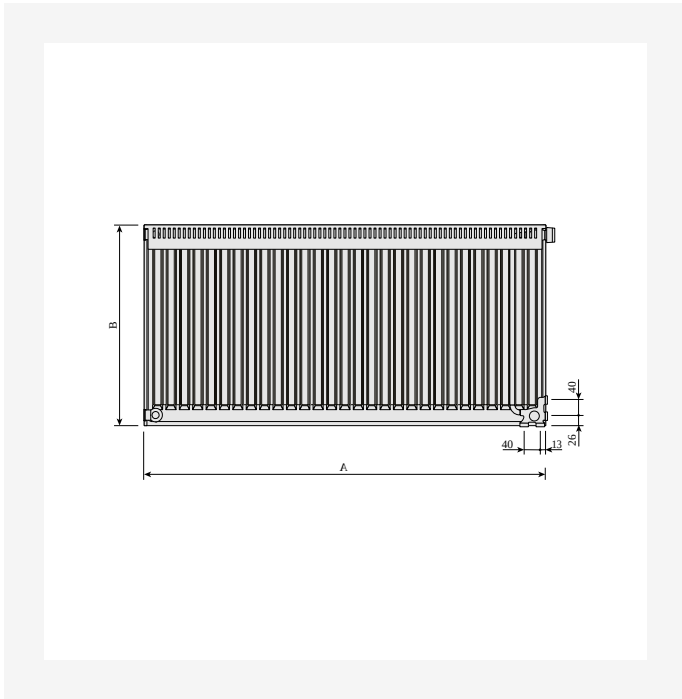

DimensionalDrawing - Thermopanel typ 11, vänster baksidesvy

DimensionalDrawing - Botten och sidoanslutning höger, ETIM 88

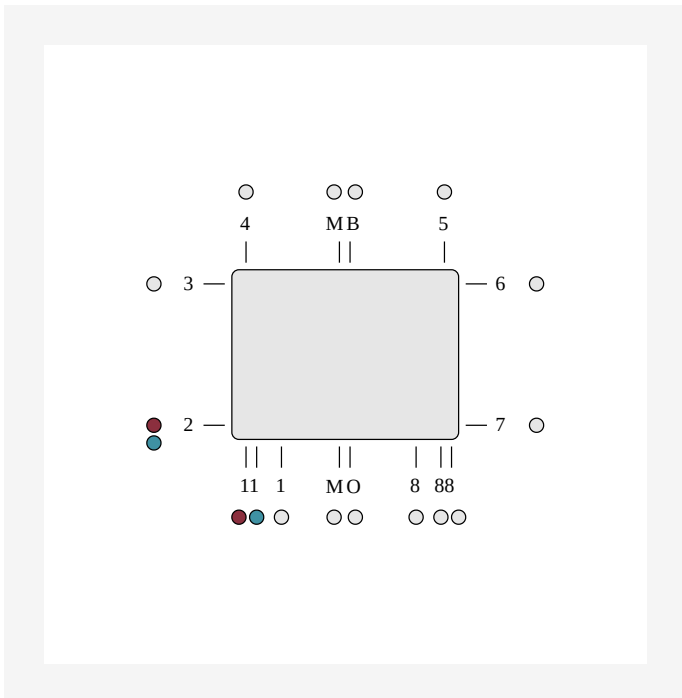

DimensionalDrawing - Botten och sidoanslutning vänster, ETIM 11



Relaterade produkter



Air



Luftskruv och blindplugg set



Bätringsfärg



Luftskruv



Väggkonsol Monclac typ
11,21,22 & 33



Slangar DHC



Bätringsfärg spray



Övergångskoppling



Radiatorkoppel ventilrörs
kona



Låsbygel



Quattro Fördelare CC40 med
avstängning



Förbigångsrör F22



Relaterade produkter

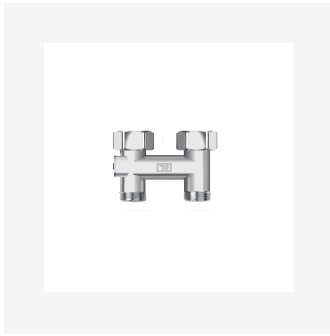

TP 1-rörs fördelare



Täcklock L22 inkl O-ring



TP TX koppling



Termostat Evosense Public



Handratt NHN



Handratt ENH



Kompressionskoppling

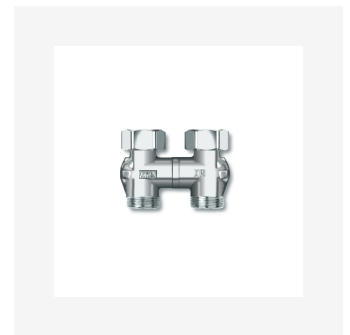

Korskoppling M22



TP Koppling M22



Förinställningsverktyg FLA



Excenterkopplingar

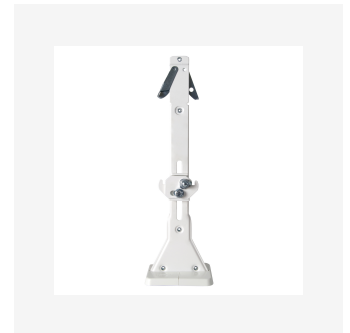

Golvkonsol Purmo Monclac



Relaterade produkter



Flamingo Ventilinsats



TP flex fördelare



200

HÖJD 200 mm	LÄNGD	DJUP	Artikelnr/ RSK (V)	Artikelnr/ RSK (H)	EFFEKT (W) 45/35/20°C	EFFEKT (W) 55/45/20°C	EFFEKT (W) 60/45/20°C	VOLYM (l)	N- EXPONENT	VIKT (kg)
Typ 21										
206	600	70	6659758		94	167	181	1.5	1.33	0.0
207	700	70	6659759		110	194	211	1.8	1.33	0.0
208	800	70	6659760		126	222	241	2.0	1.33	0.0
209	900	70	6659761		142	250	272	2.3	1.33	0.0
210	1000	70	6659762		157	278	302	2.5	1.33	0.0
211	1100	70	6659763		173	306	332	2.8	1.33	0.0
212	1200	70	6659764		189	333	362	3.0	1.33	0.0
214	1400	70	6659765		220	389	423	3.5	1.33	0.0
216	1600	70	6659766		252	445	483	4.0	1.33	0.0
218	1800	70	6659767		283	500	543	4.5	1.33	0.0
220	2000	70	6659768		315	556	603	5.0	1.33	0.0
223	2300	70	6659769		362	639	694	5.8	1.33	0.0
226	2600	70	6659770		409	722	784	6.5	1.33	0.0
230	3000	70	6659771		472	834	905	7.5	1.33	0.0
Typ 22										
206	600	102	6659772		125	219	239	1.5	1.33	0.0
207	700	102	6659773		146	255	279	1.8	1.33	0.0
208	800	102	6659774		167	292	319	2.0	1.33	0.0
209	900	102	6659775		188	328	359	2.3	1.33	0.0
210	1000	102	6659776		209	365	399	2.5	1.33	0.0
211	1100	102	6659777		229	401	439	2.8	1.33	0.0
212	1200	102	6659778		250	438	479	3.0	1.33	0.0
214	1400	102	6659779		292	511	559	3.5	1.33	0.0
216	1600	102	6659780		334	583	638	4.0	1.33	0.0



200

HÖJD 200 mm	LÄNGD	DJUP	Artikelnr/ RSK (V)	Artikelnr/ RSK (H)	EFFEKT (W) 45/35/20°C	EFFEKT (W) 55/45/20°C	EFFEKT (W) 60/45/20°C	VOLYM (l)	N- EXPONENT	VIKT (kg)
218	1800	102	6659781		375	656	718	4.5	1.33	0.0
220	2000	102	6659782		417	729	798	5.0	1.33	0.0
223	2300	102	6659783		480	839	918	5.8	1.33	0.0
226	2600	102	6659784		542	948	1037	6.5	1.33	0.0
230	3000	102	6659785		626	1094	1197	7.5	1.33	0.0
Typ 33										
206	600	152	6659787	6659786	174	307	336	2.3	1.34	0.0
207	700	152	6659789	6659788	203	358	392	2.7	1.34	0.0
208	800	152	6659791	6659790	233	409	448	3.0	1.34	0.0
209	900	152	6659793	6659792	262	460	504	3.4	1.34	0.0
210	1000	152	6659795	6659794	291	511	560	3.8	1.34	0.0
211	1100	152	6659797	6659796	320	562	616	4.2	1.34	0.0
212	1200	152	6659799	6659798	349	613	672	4.6	1.34	0.0
214	1400	152	6659801	6659800	407	716	784	5.3	1.34	0.0
216	1600	152	6659803	6659802	465	818	896	6.1	1.34	0.0
218	1800	152	6659805	6659804	524	920	1008	6.8	1.34	0.0
220	2000	152	6659807	6659806	582	1022	1120	7.6	1.34	0.0
223	2300	152	6659809	6659808	669	1176	1288	8.7	1.34	0.0
226	2600	152	6659811	6659810	756	1329	1456	9.9	1.34	0.0
230	3000	152	6659813	6659812	872	1534	1680	11.4	1.34	0.0



300

HÖJD 300 mm	LÄNGD	DJUP	Artikelnr/ RSK (V)	Artikelnr/ RSK (H)	EFFEKT (W) 45/35/20°C	EFFEKT (W) 55/45/20°C	EFFEKT (W) 60/45/20°C	VOLYM (l)	N- EXPONENT	VIKT (kg)
Typ 11										
304	400	60	6606980	6606900	65	113	122	0.7	1.30	4.4
305	500	60	6606981	6606901	81	141	152	0.8	1.30	5.2
306	600	60	6606982	6606902	97	169	183	1.0	1.30	6.0
307	700	60	6606983	6606903	113	197	213	1.2	1.30	6.8
308	800	60	6606984	6606904	129	225	244	1.4	1.30	7.6
309	900	60	6606985	6606905	145	253	274	1.5	1.30	8.3
310	1000	60	6606986	6606906	162	281	305	1.7	1.30	9.1
311	1100	60	6606987	6606907	178	309	336	1.9	1.30	10.3
312	1200	60	6606988	6606908	194	338	366	2.0	1.30	1.7
313	1300	60	6606989	6606909	210	366	396	2.2	1.30	11.5
314	1400	60	6700084	6700083	226	394	427	2.4	1.30	12.2
316	1600	60	6606990	6606910	259	450	488	2.7	1.30	13.8
318	1800	60	6606991	6606911	291	506	549	3.1	1.30	15.4
320	2000	60	6606992	6606912	323	563	610	3.4	1.30	16.9
323	2300	60	6606993	6606913	372	647	701	3.9	1.30	19.3
326	2600	60	6606994	6606914	420	731	793	4.4	1.30	21.6
330	3000	60	6606995	6606915	485	844	915	5.1	1.30	24.7
Typ 21										
304	400	70	6607062		92	158	171	1.4	1.28	6.5
305	500	70	6607063		115	198	214	1.7	1.28	7.7
306	600	70	6700093		138	237	257	2.0	1.28	9.0
307	700	70	6607064		160	277	300	2.4	1.28	1.2
308	800	70	6607065		183	317	343	2.7	1.28	11.4
309	900	70	6607066		206	356	386	3.1	1.28	12.6
310	1000	70	6607067		229	396	428	3.4	1.28	13.9



300

HÖJD 300 mm	LÄNGD	DJUP	Artikelnr/ RSK (V)	Artikelnr/ RSK (H)	EFFEKT (W) 45/35/20°C	EFFEKT (W) 55/45/20°C	EFFEKT (W) 60/45/20°C	VOLYM (l)	N- EXPONENT	VIKT (kg)
311	1100	70	6607068		252	435	471	3.7	1.28	15.1
312	1200	70	6607069		275	475	514	4.1	1.28	16.3
313	1300	70	6607070		298	514	557	4.4	1.28	17.6
314	1400	70	6700094		321	554	599	4.8	1.28	18.8
316	1600	70	6607071		367	633	686	5.4	1.28	21.3
318	1800	70	6607072		412	712	771	6.1	1.28	23.7
320	2000	70	6607073		458	791	857	6.8	1.28	26.2
323	2300	70	6607074		527	910	985	7.8	1.28	29.9
326	2600	70	6607075		596	1029	1114	8.8	1.28	33.6
330	3000	70	6607076		687	1187	1285	10.2	1.28	38.5
Typ 22										
304	400	102	6607141		112	197	213	1.4	1.31	7.4
305	500	102	6607142		141	246	267	1.7	1.31	8.8
306	600	102	6607143		169	295	321	2.0	1.31	1.2
307	700	102	6607144		197	345	374	2.4	1.31	11.6
308	800	102	6607145		225	394	427	2.7	1.31	13.0
309	900	102	6607146		253	443	481	3.1	1.31	14.3
310	1000	102	6607147		282	492	534	3.4	1.31	15.7
311	1100	102	6607148		310	542	587	3.7	1.31	17.1
312	1200	102	6607149		338	591	641	4.1	1.31	18.5
313	1300	102	6607150		366	640	694	4.4	1.31	19.9
314	1400	102	6700099		394	689	747	4.8	1.31	21.3
316	1600	102	6607151		451	788	854	5.4	1.31	24.2
318	1800	102	6607152		507	886	961	6.1	1.31	26.8
320	2000	102	6607153		563	985	1068	6.8	1.31	29.6
323	2300	102	6607154		647	1132	1228	7.8	1.31	33.7



300

HÖJD 300 mm	LÄNGD	DJUP	Artikelnr/ RSK (V)	Artikelnr/ RSK (H)	EFFEKT (W) 45/35/20°C	EFFEKT (W) 55/45/20°C	EFFEKT (W) 60/45/20°C	VOLYM (l)	N- EXPONENT	VIKT (kg)
326	2600	102	6607155		732	1280	1388	8.8	1.31	37.9
330	3000	102	6607156		845	1477	1602	10.2	1.31	43.4
Typ 33										
304	400	152	6607304	6607222	157	275	299	2.0	1.31	1.5
305	500	152	6607305	6607223	197	344	374	2.5	1.31	12.6
306	600	152	6607306	6607224	236	413	448	3.1	1.31	14.7
307	700	152	6607307	6607225	275	482	523	3.6	1.31	16.8
308	800	152	6607308	6607226	314	551	598	4.1	1.31	18.9
309	900	152	6607309	6607227	353	620	672	4.6	1.31	3.0
310	1000	152	6607310	6607228	393	688	747	5.1	1.31	23.8
311	1100	152	6607311	6607229	432	757	822	5.6	1.31	25.2
312	1200	152	6607312	6607230	471	826	896	6.1	1.31	27.3
313	1300	152	6607313	6607232	511	895	971	6.6	1.31	29.3
314	1400	152	6659955	6659954	550	964	1046	7.1	1.31	31.4
316	1600	152	6607314	6607233	629	1101	1195	8.2	1.31	35.6
318	1800	152	6607315	6607234	707	1239	1344	9.2	1.31	39.8
320	2000	152	6607316	6607235	786	1377	1493	10.2	1.31	44.0
323	2300	152	6607317	6607236	904	1583	1717	11.7	1.31	5.3
326	2600	152	6607318	6607237	1021	1790	1941	13.3	1.31	56.5
330	3000	152	6607319	6607238	1179	2065	2240	15.3	1.31	64.9



400

HÖJD 400 mm	LÄNGD	DJUP	Artikelnr/ RSK (V)	Artikelnr/ RSK (H)	EFFEKT (W) 45/35/20°C	EFFEKT (W) 55/45/20°C	EFFEKT (W) 60/45/20°C	VOLYM (l)	N- EXPONENT	VIKT (kg)
Typ 11										
404	400	60	6606996	6606916	84	146	158	0.9	1.30	5.6
405	500	60	6606998	6606917	105	183	198	1.1	1.30	6.6
406	600	60	6606999	6606918	126	219	238	1.3	1.30	7.8
407	700	60	6607000	6606919	147	256	277	1.5	1.30	8.8
408	800	60	6607001	6606920	168	292	317	1.8	1.30	10.2
409	900	60	6607002	6606921	189	329	357	2.0	1.30	1.9
410	1000	60	6607003	6606922	210	366	396	2.2	1.30	12.0
411	1100	60	6607004	6606923	231	402	436	2.4	1.30	13.5
412	1200	60	6607005	6606924	251	439	475	2.6	1.30	14.1
413	1300	60	6607006	6606925	272	475	515	2.9	1.30	15.2
414	1400	60	6700086	6700085	293	512	554	3.1	1.30	16.3
416	1600	60	6607007	6606926	335	585	634	3.5	1.30	18.4
418	1800	60	6607008	6606927	377	658	713	4.0	1.30	2.5
420	2000	60	6607009	6606928	419	731	792	4.4	1.30	22.7
423	2300	60	6607010	6606929	482	841	911	5.1	1.30	25.9
426	2600	60	6607011	6606930	545	950	1030	5.7	1.30	29.7
430	3000	60	6607012	6606931	629	1097	1189	6.6	1.30	33.4
Typ 21										
404	400	70	6607077		114	199	215	1.8	1.29	8.4
405	500	70	6607078		143	249	270	2.3	1.29	1.6
406	600	70	6607079		172	298	323	2.7	1.29	11.8
407	700	70	6607080		200	348	377	3.1	1.29	13.3
408	800	70	6607081		229	398	431	3.6	1.29	15.0
409	900	70	6607082		258	448	485	4.0	1.29	16.6
410	1000	70	6607083		286	497	539	4.5	1.29	18.3



400

HÖJD 400 mm	LÄNGD	DJUP	Artikelnr/ RSK (V)	Artikelnr/ RSK (H)	EFFEKT (W) 45/35/20°C	EFFEKT (W) 55/45/20°C	EFFEKT (W) 60/45/20°C	VOLYM (l)	N- EXPONENT	VIKT (kg)
411	1100	70	6607084		315	547	592	5.0	1.29	19.9
412	1200	70	6607085		344	597	647	5.4	1.29	21.5
413	1300	70	6607086		372	646	700	5.8	1.29	23.2
414	1400	70	6700095		401	696	754	6.3	1.29	24.8
416	1600	70	6607087		458	796	862	7.2	1.29	28.9
418	1800	70	6607088		515	895	969	8.1	1.29	31.4
420	2000	70	6607089		572	994	1077	9.0	1.29	34.6
423	2300	70	6607090		658	1144	1239	10.3	1.29	39.6
426	2600	70	6607091		744	1293	1401	11.7	1.29	44.5
430	3000	70	6607092		859	1492	1616	13.5	1.29	51.2
Typ 22										
404	400	102	6607157		142	249	270	1.8	1.32	9.6
405	500	102	6607158		178	311	338	2.3	1.32	11.5
406	600	102	6607159		213	374	406	2.7	1.32	13.4
407	700	102	6607160		248	436	473	3.1	1.32	15.3
408	800	102	6607161		284	498	541	3.6	1.32	17.2
409	900	102	6607162		319	560	608	4.0	1.32	19.8
410	1000	102	6607163		355	623	676	4.5	1.32	3.0
411	1100	102	6607164		390	685	743	5.0	1.32	22.9
412	1200	102	6607165		426	747	811	5.4	1.32	24.8
413	1300	102	6607166		461	810	878	5.8	1.32	26.7
414	1400	102	6700100		496	872	946	6.3	1.32	28.6
416	1600	102	6607167		568	996	1081	7.2	1.32	32.4
418	1800	102	6607168		639	1121	1216	8.1	1.32	36.3
420	2000	102	6607169		709	1245	1351	9.0	1.32	4.1
423	2300	102	6607170		816	1432	1554	10.3	1.32	45.7



400

HÖJD 400 mm	LÄNGD	DJUP	Artikelnr/ RSK (V)	Artikelnr/ RSK (H)	EFFEKT (W) 45/35/20°C	EFFEKT (W) 55/45/20°C	EFFEKT (W) 60/45/20°C	VOLYM (l)	N- EXPONENT	VIKT (kg)
426	2600	102	6607171		922	1619	1757	11.7	1.32	51.4
430	3000	102	6607172		1064	1868	2027	13.5	1.32	59.4
Typ 33										
404	400	152	6607320	6607239	196	345	375	2.7	1.33	13.8
405	500	152	6607321	6607240	245	432	469	3.4	1.33	16.6
406	600	152	6607322	6607241	294	518	562	4.0	1.33	19.4
407	700	152	6607323	6607242	343	604	656	4.7	1.33	22.3
408	800	152	6607324	6607243	392	691	750	5.4	1.33	25.9
409	900	152	6607325	6607244	441	777	843	6.0	1.33	27.9
410	1000	152	6607326	6607245	490	863	937	6.7	1.33	31.7
411	1100	152	6607327	6607246	539	950	1031	7.4	1.33	33.6
412	1200	152	6607328	6607248	588	1036	1125	8.0	1.33	36.4
413	1300	152	6607329	6607249	637	1122	1218	8.7	1.33	39.2
414	1400	152	6659957	6659956	686	1209	1312	9.4	1.33	42.3
416	1600	152	6607330	6607250	784	1381	1499	10.7	1.33	47.7
418	1800	152	6607331	6607251	882	1554	1687	12.1	1.33	53.4
420	2000	152	6607332	6607252	980	1726	1874	13.4	1.33	59.0
423	2300	152	6607333	6607253	1128	1985	2155	15.4	1.33	67.4
426	2600	152	6607334	6607254	1274	2244	2436	17.4	1.33	75.9
430	3000	152	6607335	6607255	1471	2590	2811	20.1	1.33	87.2



500

HÖJD 500 mm	LÄNGD	DJUP	Artikelnr/ RSK (V)	Artikelnr/ RSK (H)	EFFEKT (W) 45/35/20°C	EFFEKT (W) 55/45/20°C	EFFEKT (W) 60/45/20°C	VOLYM (l)	N- EXPONENT	VIKT (kg)
Typ 11										
504	400	60	6607013	6606932	102	178	193	1.1	1.31	6.9
505	500	60	6607014	6606933	127	223	241	1.4	1.31	8.2
506	600	60	6607015	6606934	153	267	290	1.6	1.31	9.5
507	700	60	6607016	6606935	178	312	338	1.9	1.31	1.8
508	800	60	6607017	6606936	204	356	386	2.2	1.31	12.1
509	900	60	6607018	6606937	229	401	434	2.4	1.31	13.4
510	1000	60	6607019	6606938	255	445	483	2.7	1.31	14.7
511	1100	60	6607020	6606939	280	490	531	3.0	1.31	16.4
512	1200	60	6607021	6606940	306	534	579	3.2	1.31	17.4
513	1300	60	6607022	6606941	331	579	627	3.5	1.31	18.7
514	1400	60	6700088	6700087	357	623	676	3.8	1.31	20.0
516	1600	60	6607023	6606942	408	712	772	4.3	1.31	22.6
518	1800	60	6607025	6606943	459	801	869	4.9	1.31	25.2
520	2000	60	6607026	6606944	510	890	965	5.4	1.31	27.8
523	2300	60	6607027	6606945	586	1024	1110	6.2	1.31	31.8
526	2600	60	6607028	6606946	663	1158	1255	7.0	1.31	35.7
530	3000	60	6607029	6606947	764	1336	1448	8.1	1.31	4.9
Typ 21										
504	400	70	6607093		136	237	257	2.2	1.31	1.8
505	500	70	6607094		170	296	321	2.8	1.31	12.2
506	600	70	6607095		204	356	386	3.3	1.31	14.3
507	700	70	6607096		237	415	450	3.9	1.31	16.3
508	800	70	6607097		271	474	514	4.4	1.31	18.4
509	900	70	6607098		305	533	578	5.0	1.31	2.5
510	1000	70	6607099		339	593	643	5.5	1.31	22.6



500

HÖJD 500 mm	LÄNGD	DJUP	Artikelnr/ RSK (V)	Artikelnr/ RSK (H)	EFFEKT (W) 45/35/20°C	EFFEKT (W) 55/45/20°C	EFFEKT (W) 60/45/20°C	VOLYM (l)	N- EXPONENT	VIKT (kg)
511	1100	70	6607100		373	652	707	6.0	1.31	24.7
512	1200	70	6607101		407	711	771	6.6	1.31	26.7
513	1300	70	6607102		441	771	836	7.2	1.31	28.8
514	1400	70	6700096		475	830	900	7.7	1.31	3.9
516	1600	70	6607103		543	948	1029	8.8	1.31	35.8
518	1800	70	6607104		611	1067	1157	9.9	1.31	39.3
520	2000	70	6607105		678	1185	1285	11.0	1.31	43.5
523	2300	70	6607106		780	1363	1478	12.7	1.31	49.7
526	2600	70	6607107		882	1541	1671	14.3	1.31	55.9
530	3000	70	6607108		1018	1778	1928	16.5	1.31	64.2
Typ 22										
504	400	102	6607173		169	299	324	2.2	1.33	11.9
505	500	102	6607174		212	373	405	2.8	1.33	14.2
506	600	102	6607175		254	448	486	3.3	1.33	16.5
507	700	102	6607176		296	522	567	3.9	1.33	19.0
508	800	102	6607177		339	597	648	4.4	1.33	21.3
509	900	102	6607178		381	672	729	5.0	1.33	23.6
510	1000	102	6607179		424	746	810	5.5	1.33	26.9
511	1100	102	6607180		466	821	891	6.0	1.33	28.4
512	1200	102	6607181		508	896	972	6.6	1.33	3.7
513	1300	102	6607182		551	970	1053	7.2	1.33	33.1
514	1400	102	6700101		593	1045	1134	7.7	1.33	35.5
516	1600	102	6607183		678	1194	1296	8.8	1.33	4.2
518	1800	102	6607184		762	1343	1458	9.9	1.33	44.9
520	2000	102	6607185		847	1493	1620	11.0	1.33	49.7
523	2300	102	6607186		974	1717	1863	12.7	1.33	56.8



500

HÖJD 500 mm	LÄNGD	DJUP	Artikelnr/ RSK (V)	Artikelnr/ RSK (H)	EFFEKT (W) 45/35/20°C	EFFEKT (W) 55/45/20°C	EFFEKT (W) 60/45/20°C	VOLYM (l)	N- EXPONENT	VIKT (kg)
526	2600	102	6607187		1101	1940	2106	14.3	1.33	63.9
530	3000	102	6607188		1271	2239	2431	16.5	1.33	73.3
Typ 33										
504	400	152	6607336	6607256	232	411	447	3.3	1.34	16.9
505	500	152	6607337	6607257	291	514	559	4.1	1.34	2.5
506	600	152	6607338	6607258	348	617	670	4.9	1.34	24.1
507	700	152	6607339	6607259	407	719	782	5.7	1.34	27.7
508	800	152	6607340	6607260	465	822	893	6.6	1.34	31.3
509	900	152	6607341	6607261	523	925	1005	7.4	1.34	34.9
510	1000	152	6607342	6607262	581	1028	1116	8.2	1.34	38.6
511	1100	152	6607343	6607263	639	1131	1228	9.0	1.34	42.2
512	1200	152	6607344	6607264	697	1233	1340	9.8	1.34	45.8
513	1300	152	6607345	6607265	755	1336	1452	10.7	1.34	49.4
514	1400	152	6659959	6659958	813	1439	1563	11.5	1.34	53.2
516	1600	152	6607346	6607266	929	1645	1786	13.1	1.34	6.3
518	1800	152	6607347	6607267	1045	1850	2010	14.8	1.34	67.5
520	2000	152	6607348	6607268	1162	2056	2233	16.4	1.34	74.8
523	2300	152	6607349	6607269	1336	2364	2568	18.9	1.34	85.5
526	2600	152	6607350	6607270	1510	2672	2903	21.3	1.34	100.2
530	3000	152	6607351	6607271	1742	3084	3349	24.6	1.34	118



600

HÖJD 600 mm	LÄNGD	DJUP	Artikelnr/ RSK (V)	Artikelnr/ RSK (H)	EFFEKT (W) 45/35/20°C	EFFEKT (W) 55/45/20°C	EFFEKT (W) 60/45/20°C	VOLYM (l)	N- EXPONENT	VIKT (kg)
Typ 11										
604	400	60	6607030	6606948	119	208	226	1.3	1.31	8.4
605	500	60	6607031	6606949	149	260	282	1.6	1.31	10.0
606	600	60	6607032	6606950	179	313	339	1.9	1.31	11.2
607	700	60	6607033	6606951	208	365	396	2.2	1.31	12.8
608	800	60	6607034	6606952	238	417	452	2.6	1.31	14.4
609	900	60	6607035	6606953	268	469	508	2.9	1.31	16.2
610	1000	60	6607036	6606954	298	521	565	3.2	1.31	17.6
611	1100	60	6607037	6606955	327	573	622	3.5	1.31	19.2
612	1200	60	6607038	6606956	357	625	678	3.8	1.31	2.8
613	1300	60	6607039	6606957	387	677	734	4.2	1.31	22.4
614	1400	60	6700090	6700089	417	729	791	4.5	1.31	24.0
616	1600	60	6607040	6606958	476	834	904	5.1	1.31	27.2
618	1800	60	6607041	6606959	536	938	1017	5.8	1.31	3.3
620	2000	60	6607042	6606960	595	1042	1130	6.4	1.31	33.5
623	2300	60	6607043	6606961	684	1198	1299	7.4	1.31	38.3
626	2600	60	6607044	6606962	774	1354	1469	8.3	1.31	43.6
630	3000	60	6607045	6606963	893	1563	1695	9.6	1.31	49.4
Typ 21										
604	400	70	6607109		155	273	296	2.6	1.32	12.2
605	500	70	6607110		194	341	370	3.3	1.32	14.7
606	600	70	6607111		233	409	444	4.0	1.32	17.2
607	700	70	6607112		272	478	518	4.6	1.32	19.7
608	800	70	6607113		311	546	592	5.3	1.32	22.2
609	900	70	6607114		349	614	666	5.9	1.32	24.7
610	1000	70	6607115		388	682	740	6.6	1.32	27.2



600

HÖJD 600 mm	LÄNGD	DJUP	Artikelnr/ RSK (V)	Artikelnr/ RSK (H)	EFFEKT (W) 45/35/20°C	EFFEKT (W) 55/45/20°C	EFFEKT (W) 60/45/20°C	VOLYM (l)	N- EXPONENT	VIKT (kg)
611	1100	70	6607116		427	751	814	7.3	1.32	29.7
612	1200	70	6607117		466	819	889	7.9	1.32	32.2
613	1300	70	6607118		505	887	963	8.6	1.32	34.7
614	1400	70	6700097		543	955	1037	9.2	1.32	37.3
616	1600	70	6607119		621	1092	1185	10.6	1.32	42.3
618	1800	70	6607120		699	1228	1333	11.9	1.32	47.3
620	2000	70	6607121		776	1365	1481	13.2	1.32	52.3
623	2300	70	6607122		893	1569	1703	15.2	1.32	59.8
626	2600	70	6607123		1009	1774	1925	17.2	1.32	67.4
630	3000	70	6607124		1164	2047	2221	19.8	1.32	77.4
Typ 22										
604	400	102	6607189		195	346	375	2.6	1.34	14.1
605	500	102	6607190		244	432	469	3.3	1.34	17.4
606	600	102	6607191		293	518	563	4.0	1.34	19.9
607	700	102	6607192		342	605	657	4.6	1.34	22.9
608	800	102	6607193		391	691	750	5.3	1.34	25.8
609	900	102	6607194		440	777	844	5.9	1.34	28.7
610	1000	102	6607195		488	864	938	6.6	1.34	31.6
611	1100	102	6607196		537	950	1032	7.3	1.34	34.5
612	1200	102	6607197		586	1037	1126	7.9	1.34	37.4
613	1300	102	6607198		635	1123	1220	8.6	1.34	4.3
614	1400	102	6700102		684	1209	1314	9.2	1.34	43.3
616	1600	102	6607199		781	1382	1501	10.6	1.34	50.0
618	1800	102	6607200		879	1555	1689	11.9	1.34	54.9
620	2000	102	6607201		977	1728	1876	13.2	1.34	6.8
623	2300	102	6607202		1123	1987	2158	15.2	1.34	69.5



600

HÖJD 600 mm	LÄNGD	DJUP	Artikelnr/ RSK (V)	Artikelnr/ RSK (H)	EFFEKT (W) 45/35/20°C	EFFEKT (W) 55/45/20°C	EFFEKT (W) 60/45/20°C	VOLYM (l)	N- EXPONENT	VIKT (kg)
626	2600	102	6607203		1270	2246	2439	17.2	1.34	78.2
630	3000	102	6607204		1465	2591	2815	19.8	1.34	89.9
Typ 33										
604	400	152	6607352	6607272	266	473	514	3.9	1.35	2.2
605	500	152	6607353	6607273	333	592	643	4.9	1.35	24.6
606	600	152	6607354	6607274	399	710	772	5.9	1.35	28.9
607	700	152	6607355	6607275	466	828	900	6.9	1.35	33.2
608	800	152	6607356	6607276	532	946	1029	7.8	1.35	37.5
609	900	152	6607357	6607277	599	1065	1157	8.8	1.35	41.9
610	1000	152	6607358	6607278	665	1183	1286	9.8	1.35	46.2
611	1100	152	6607359	6607279	732	1301	1415	10.8	1.35	5.5
612	1200	152	6607360	6607280	798	1420	1543	11.8	1.35	54.9
613	1300	152	6607361	6607281	865	1538	1672	12.7	1.35	59.2
614	1400	152	6659961	6659960	931	1656	1800	13.7	1.35	63.5
616	1600	152	6607362	6607282	1064	1893	2058	15.7	1.35	72.2
618	1800	152	6607363	6607283	1197	2129	2315	17.6	1.35	8.8
620	2000	152	6607364	6607284	1330	2366	2572	19.6	1.35	89.5
623	2300	152	6607365	6607285	1530	2721	2958	22.5	1.35	106.6
626	2600	152	6607366	6607286	1730	3076	3344	25.5	1.35	115.5
630	3000	152	6607367	6607287	1996	3549	3858	29.4	1.35	132.8



900

HÖJD 900 mm	LÄNGD	DJUP	Artikelnr/ RSK (V)	Artikelnr/ RSK (H)	EFFEKT (W) 45/35/20°C	EFFEKT (W) 55/45/20°C	EFFEKT (W) 60/45/20°C	VOLYM (l)	N- EXPONENT	VIKT (kg)
Typ 11										
904	400	60	6607046	6606964	166	291	316	1.8	1.32	11.6
905	500	60	6607047	6606965	208	364	395	2.3	1.32	14.6
906	600	60	6607048	6606966	249	437	474	2.7	1.32	16.4
907	700	60	6607049	6606967	291	510	553	3.1	1.32	18.9
908	800	60	6607050	6606968	332	583	632	3.6	1.32	21.3
909	900	60	6607051	6606969	373	655	711	4.0	1.32	23.7
910	1000	60	6607052	6606970	415	728	790	4.5	1.32	26.2
911	1100	60	6607053	6606971	457	801	869	5.0	1.32	28.6
912	1200	60	6607054	6606972	498	874	948	5.4	1.32	31.2
913	1300	60	6607055	6606973	540	947	1027	5.8	1.32	33.5
914	1400	60	6700092	6700091	581	1019	1106	6.3	1.32	35.9
916	1600	60	6607056	6606974	664	1165	1264	7.2	1.32	4.7
Typ 21										
904	400	70	6607125		212	376	408	3.6	1.34	17.5
905	500	70	6607126		265	470	510	4.5	1.34	21.4
906	600	70	6607127		318	563	612	5.4	1.34	25.2
907	700	70	6607128		371	657	714	6.3	1.34	29.4
908	800	70	6607129		424	751	816	7.2	1.34	32.9
909	900	70	6607130		477	845	918	8.1	1.34	36.7
910	1000	70	6607131		530	939	1020	9.0	1.34	4.6
911	1100	70	6607132		583	1033	1122	9.9	1.34	44.4
912	1200	70	6607133		636	1127	1224	10.8	1.34	48.2
913	1300	70	6607134		689	1221	1326	11.7	1.34	52.7
914	1400	70	6700098		742	1315	1428	12.6	1.34	55.9
916	1600	70	6607135		848	1502	1632	14.4	1.34	63.6



900

HÖJD 900 mm	LÄNGD	DJUP	Artikelnr/ RSK (V)	Artikelnr/ RSK (H)	EFFEKT (W) 45/35/20°C	EFFEKT (W) 55/45/20°C	EFFEKT (W) 60/45/20°C	VOLYM (l)	N- EXPONENT	VIKT (kg)
Typ 22										
904	400	102	6607205		268	478	520	3.6	1.36	2.4
905	500	102	6607206		335	597	650	4.5	1.36	24.8
906	600	102	6607207		402	717	780	5.4	1.36	29.1
907	700	102	6607208		469	836	910	6.3	1.36	33.4
908	800	102	6607209		536	956	1039	7.2	1.36	37.8
909	900	102	6607210		603	1075	1169	8.1	1.36	42.1
910	1000	102	6607211		670	1194	1299	9.0	1.36	46.5
911	1100	102	6607212		737	1314	1429	9.9	1.36	5.8
912	1200	102	6607213		804	1433	1559	10.8	1.36	55.1
913	1300	102	6607214		870	1553	1689	11.7	1.36	59.5
914	1400	102	6700103		937	1672	1819	12.6	1.36	63.8
916	1600	102	6607215		1071	1911	2079	14.4	1.36	72.4
Typ 33										
904	400	152	6607368	6607288	364	651	708	5.3	1.36	29.7
905	500	152	6607369	6607289	455	814	885	6.7	1.36	36.3
906	600	152	6607370	6607290	546	976	1062	8.0	1.36	42.9
907	700	152	6607371	6607291	637	1139	1239	9.3	1.36	49.4
908	800	152	6607372	6607292	729	1302	1416	10.6	1.36	56.0
909	900	152	6607373	6607293	820	1465	1593	12.0	1.36	62.6
910	1000	152	6607374	6607294	911	1627	1770	13.3	1.36	69.1
911	1100	152	6607375	6607295	1002	1790	1947	14.6	1.36	75.7
912	1200	152	6607376	6607296	1093	1953	2124	16.0	1.36	82.3
913	1300	152	6607377	6607297	1184	2116	2301	17.3	1.36	88.8
914	1400	152	6659963	6659962	1275	2278	2478	18.6	1.36	104.6
916	1600	152	6607378	6607298	1457	2604	2832	21.3	1.36	112.8

