



Datablad

2026-07-05

# Compact

Standardradiator med 4 x 1/2" anslutning, galler och sidoplåtar.



- ✓ Galler och sidoplåtar på alla modeller
- ✓ Kan monteras på golvkonsol
- ✓ Även för diagonal och ryttarkoppling
- ✓ Effektiv värmefördelning
- ✓ Brett utbud av färger

**Compact** är med sin stilrena design en klassisk panelradiator för slutna vattenburna värmesystem. Panelradiator Compact har fyra G 1/2" anslutningar med invändig gänga, vilket möjliggör sidoanslutning på både höger och vänster sida. En verklig kvalitetsradiator med mycket hög finish. Compact är konstruerad för optimal värmeavgivning enligt standarden EN442-1 och alla modeller är CE-märkta. Compact levereras med monterade sidoplåtar och toppgaller med barnsäker infästning. Konsoler, galler, sidoplåtar, blindpropp och luftskruv ingår. Driftsförhållandena bör alltid beaktas och monteringsanvisning bör följas vid installation. Standardfärg vit RAL 9016 (på begäran även andra kulörer mot en extra kostnad). Garantitiden är 10 år. Leveransinnehåll: Purmo Compact är försedd med monterade sidoplåtar och toppgaller samt omfattande konsoler, luftskruv och propp. Övrigt: Purmo Compact finns i typ 11, 21, 22 och 33.



### Användningsområde

Lämplig för bostads- och kommersiella byggnader. Perfekt för flerbostadshus, fjärrvärmesystem och större installationer.

### Dimensionering

Effekter för olika driftstemperaturer finns i tabell nedan. För andra temperaturer rekommenderas hemsida eller excel-fil. Produkten finns också i Magicloud för detaljerad beräkning.

### Användning

Inkoppling sker genom 4 x G 1/2" sidouttag, tillopp i toppen och retur i botten. Kan också kopplas in diagonalt utan effektförlust. Seriekoppling av flera radiatorer rekommenderas ej på grund av risk för stort effekttapp på den seriekopplade radiatoren. Monteras i torra miljöer, ej lämplig där återkommande hög luftfuktighet förekommer.

### AMA Text

PTB.1 Radiatorer

PTB.11 Panelradiatorer

Purmo Typ Compact:

Fabrikat Purmo typ Compact. Tryckklass PN10. Försedd med sidoplåtar och toppgaller. Kulör Vit RAL 9016.

Levereras med luftningsventil, bottenplugg och omfattande låsbara Monclac väggkonsoler. Levereras skyddsemballerad och med frontskydd som tas bort i samband med slutrengöring.

C XX-HLL (ex. PURMO C 11 300x400)

Effektgrupp-höjd, längd (mm)

Kompletterande text:

Förses med MMA-koppel

Tillbehör panelradiatorer:

Golvkonsoler

Låsbyglar för offentliga lokaler

Tilluftsdon Purmo Air

Handduksstång



# Specifikationer

| EGENSKAPER                                       | ENHET | VÄRDEN         |
|--|-------|----------------|
| ETIM Class                                       |       | EC011022       |
| Material   |       | Stål           |
| Typ  |       | 11, 21, 22, 33 |
| Ytstruktur                                       |       | Profilerad     |
| Max arbetstryck                                  | bar   | 10             |
| Antal standardanslutningar                       |       | 4              |
| Värmeangivning enligt erkänt EN 442-laboratorium |       | Ja             |
| Max. driftstemperatur                            | °C    | 110            |
| Standardfärg                                     |       | Ja             |
| Färg   |       | Vit            |
| RAL nummer                                       |       | 9016           |
| Galler/Täckplåt                                  |       | Ja             |
| Galler/Täckplåt                                  |       | Ja             |
| Glansvärde                                       |       | Blank          |
| Gängdimension (tum)                              |       | 1/2"           |
| Anslutning gänga                                 |       | Invändig gänga |
| Med enpunksanslutning                            |       | Ja             |
| Med luftningsanslutning                          |       | Ja             |
| Med luftningsventil/avluftare                    |       | Ja             |
| Med avtappningsmöjlighet                         |       | Ja             |



# Dokument

| DOKUMENT  | DOKUMENTTYP  | LÄNK  |
|---|--------------|---|
| Datablad Kulörer -<br>Panelradiatorer och Konvektorer | Brochure     | <a href="https://asset.productmarketingcloud.com/api/assetstorage/3577_68e483fa-ca55-43d0-bcd9-2d8f352bad7b">https://asset.productmarketingcloud.com/api/assetstorage/3577_68e483fa-ca55-43d0-bcd9-2d8f352bad7b</a> |
| Purmo Konzeptbroschyr                                 | Brochure     | <a href="https://asset.productmarketingcloud.com/api/assetstorage/3577_bd3b1722-bd77-469b-8a77-09d0bdcd4214">https://asset.productmarketingcloud.com/api/assetstorage/3577_bd3b1722-bd77-469b-8a77-09d0bdcd4214</a> |
| Drift och skötsel Radiatorer och<br>konvektorer       | User         | <a href="https://asset.productmarketingcloud.com/api/assetstorage/3577_bc72a430-42d1-4e59-ae7e-2ad7324d15cd">https://asset.productmarketingcloud.com/api/assetstorage/3577_bc72a430-42d1-4e59-ae7e-2ad7324d15cd</a> |
| Användarmanual - Flamingo V2<br>(FLA)                 | Installation | <a href="https://asset.productmarketingcloud.com/api/assetstorage/3577_d7d4bd99-e485-4573-aeaf-a6fab22b9253">https://asset.productmarketingcloud.com/api/assetstorage/3577_d7d4bd99-e485-4573-aeaf-a6fab22b9253</a> |



# Resurser



ProductImage - Purmo Compact, C, detail above.



ProductImage - Purmo Compact, C, product image 30 degrees.

| COMPACT (mm) |     |      |                |      |
|--------------|-----|------|----------------|------|
|              | C11 |      | C21s, C22, C33 |      |
| A            | a1  | a2   | a1             | a2   |
| 400-1600     | 117 | -    | 133            | -    |
| 1800         | 117 | 917  | 133            | 900  |
| 2000         | 117 | 1017 | 133            | 1000 |
| 2300         | 117 | 1150 | 133            | 1167 |
| 2600         | 117 | 1317 | 133            | 1300 |
| 3000         | 117 | 1517 | 133            | 1500 |

DimensionalDrawing - Compact, mått på byggelplacering

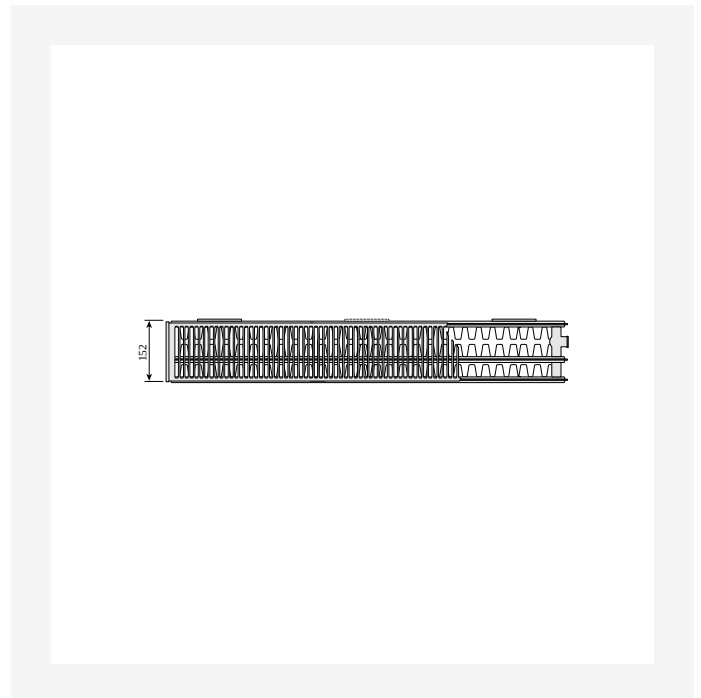

DimensionalDrawing - Compact, typ 33 toppvy



# Resurser

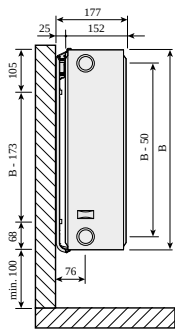

DimensionalDrawing - Compact, typ 33 sidovy

DimensionalDrawing - Compact, typ 22 toppvy

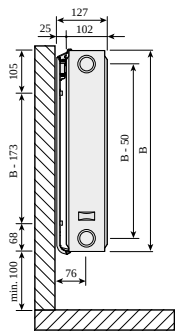

DimensionalDrawing - Compact, typ 22 sidovy

DimensionalDrawing - Compact, typ 21 toppvy



# Resurser

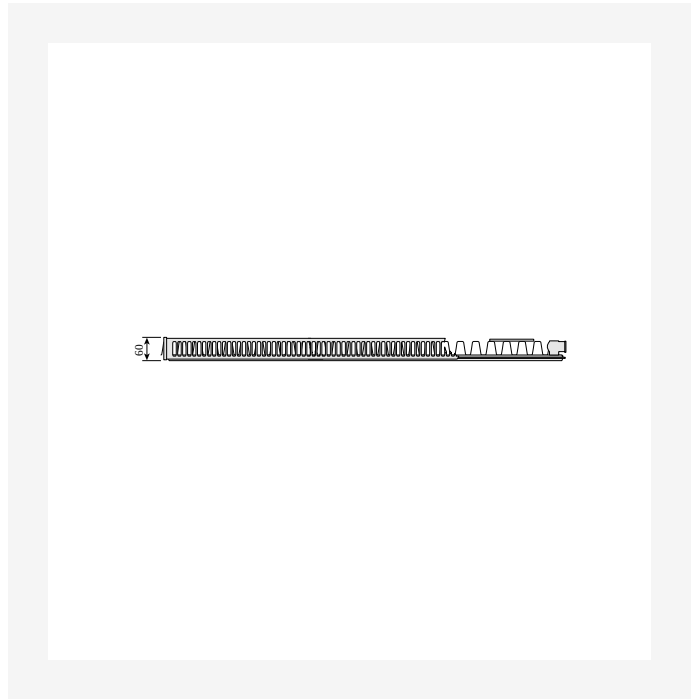
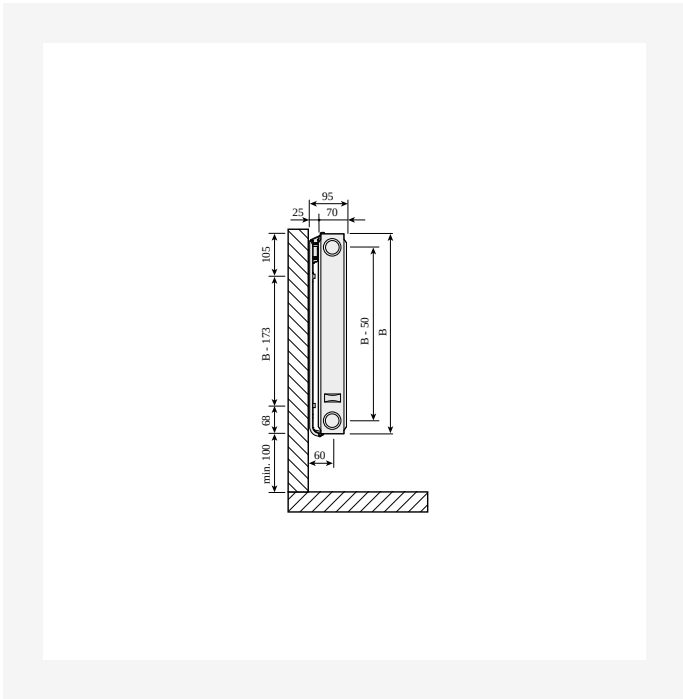

DimensionalDrawing - Compact, typ 21 sidovy

DimensionalDrawing - Compact, typ 11 toppvy

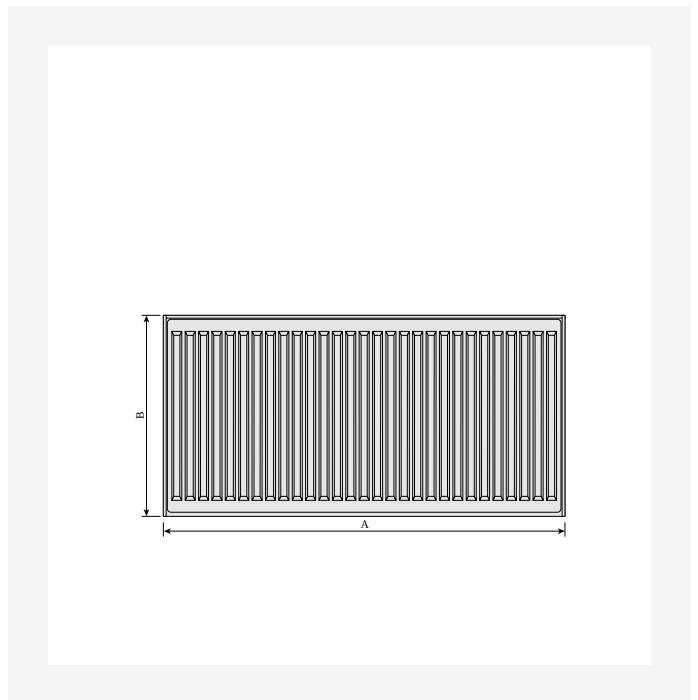
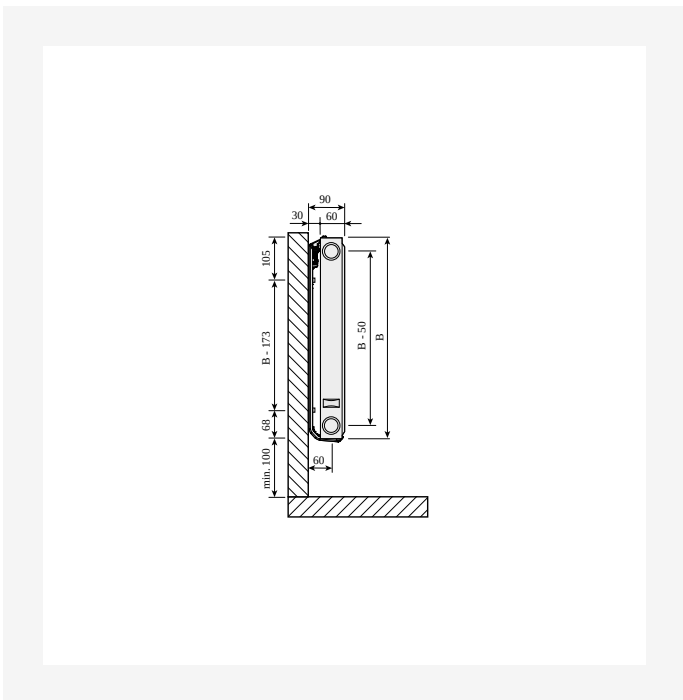

DimensionalDrawing - Compact, typ 11 sidovy

DimensionalDrawing - Compact, frontvy



# Resurser

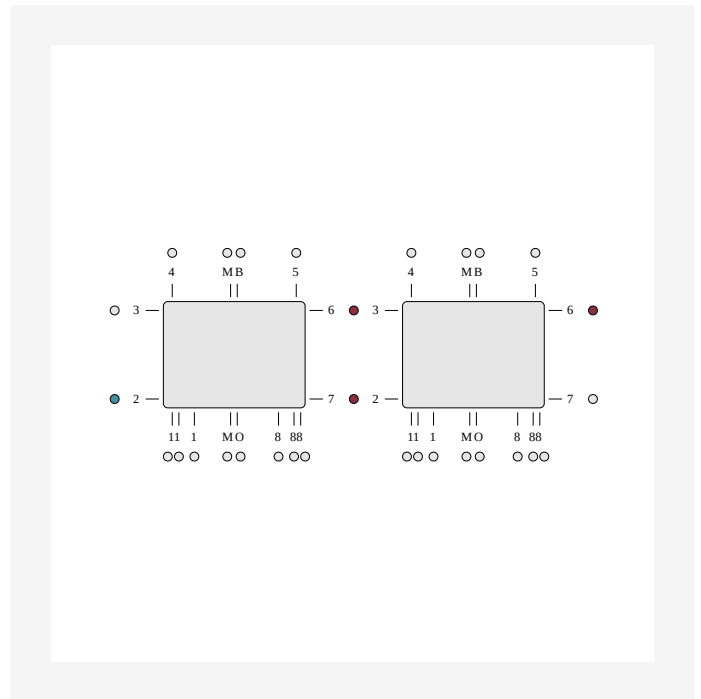
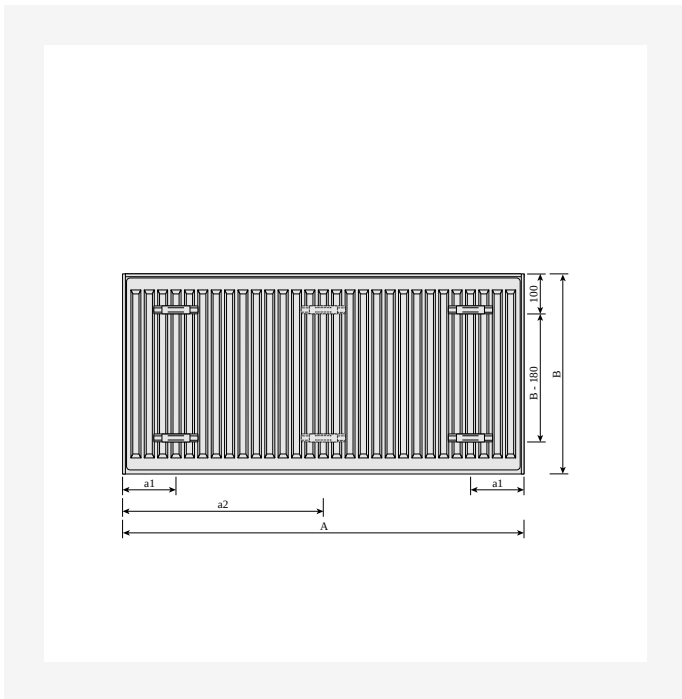

DimensionalDrawing - Compact, baksidesvy

DimensionalDrawing - Seriekoppling höger ETIM 62

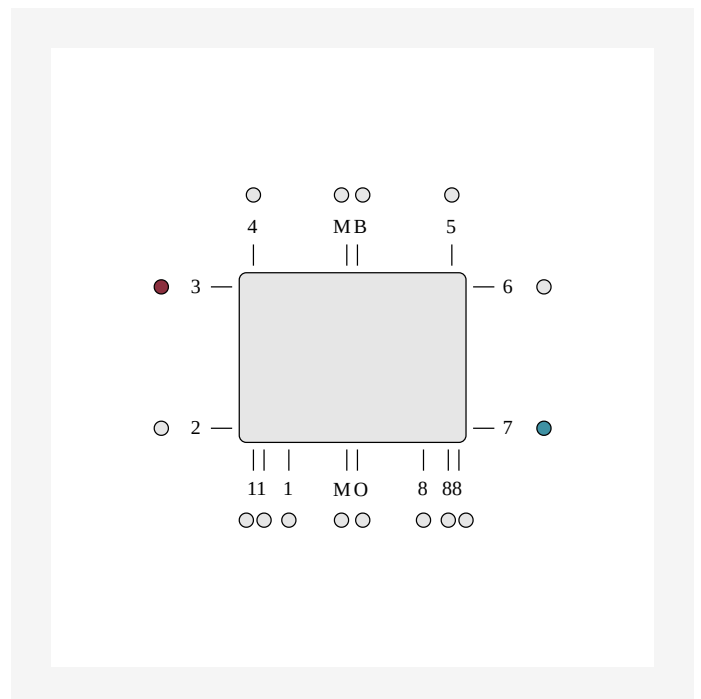
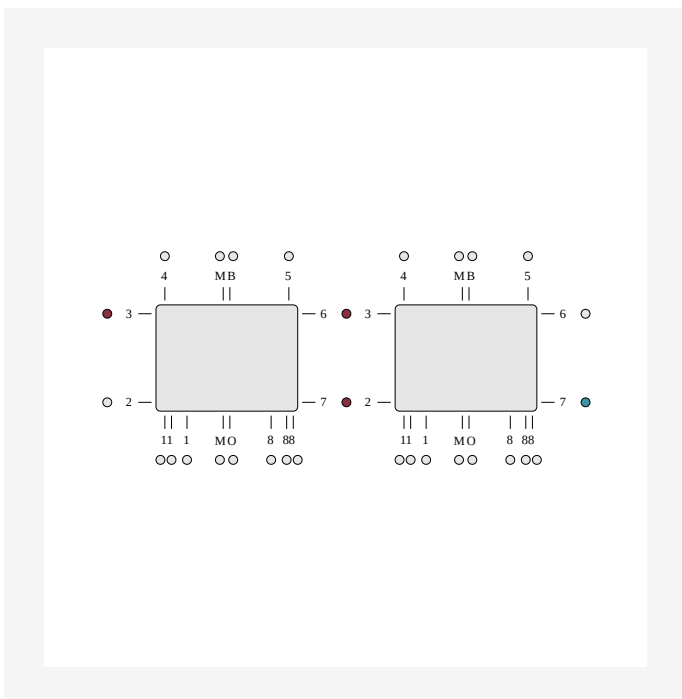

DimensionalDrawing - Diagonal seriekoppling vänster ETIM 37

DimensionalDrawing - Diagonal anslutning ETIM 37



# Resurser

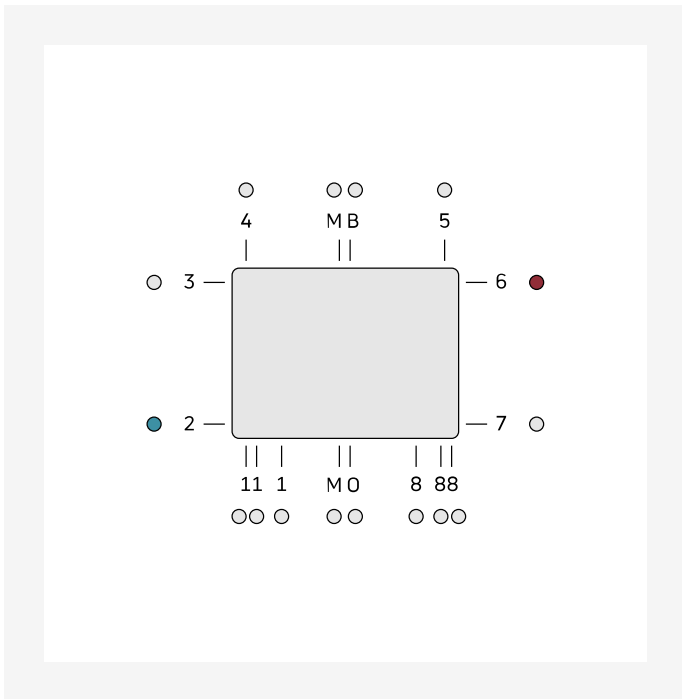

DimensionalDrawing - Diagonal anslutning ETIM 62.



# Relaterade produkter



Sensor



Toppaller Purmo/TP



Air



Luftskruv och blindplugg set



Bättringsfärg



Sidopanel Purmo



Luftskruv



Väggkonsol Monclac typ 11,21,22 & 33



Luftnyckel



Flex Radiatorkoppel



Radiatorkoppel Evoflow



Låsbygel



# Relaterade produkter

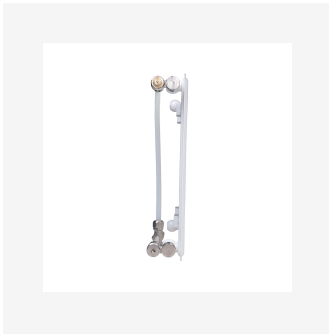

Radiator koppel FLK



Termostat Evosense



Returventil RV

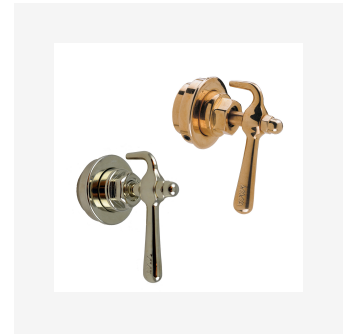

Slottsvred SNH



Evosense Sprint Termostat



Inklädnad av konsollben



Evoflow Radiator ventil



Slottsv ventil FV



Termostat Evosense Public



Returventil RRV

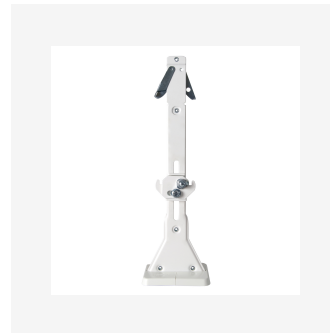

Golvkonsol Purmo Monclac



Slottsv ventil returventil



# Relaterade produkter

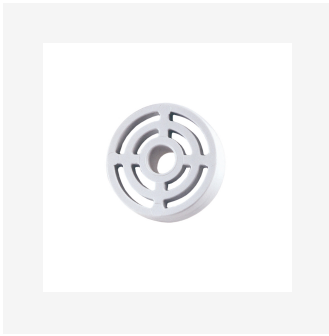

Väggdistans



Evosense Remote Termostat



Fängelsekonsol



# 300

| HÖJD<br>300 mm | LÄNGD | DJUP | Artikelnr/<br>RSK (V) | Artikelnr/<br>RSK (H) | EFFEKT (W)<br>45/35/20°C | EFFEKT (W)<br>55/45/20°C | EFFEKT (W)<br>60/45/20°C | VOLYM<br>(l) | N-<br>EXPONENT | VIKT<br>(kg) |
|----------------|-------|------|-----------------------|-----------------------|--------------------------|--------------------------|--------------------------|--------------|----------------|--------------|
| <b>Typ 11</b>  |       |      |                       |                       |                          |                          |                          |              |                |              |
| 400            | 60    |      | F061103004010300      | 6732906               | 65                       | 113                      | 122                      | 0.7          | 1.30           | 4.4          |
| 500            | 60    |      |                       | 6732907               | 81                       | 141                      | 152                      | 0.8          | 1.30           | 5.1          |
| 600            | 60    |      | F061103006010300      | 6732908               | 97                       | 169                      | 183                      | 1.0          | 1.30           | 5.9          |
| 700            | 60    |      |                       | 6732909               | 113                      | 197                      | 213                      | 1.2          | 1.30           | 6.7          |
| 800            | 60    |      |                       | 6732910               | 129                      | 225                      | 244                      | 1.4          | 1.30           | 7.5          |
| 900            | 60    |      |                       | 6732911               | 145                      | 253                      | 274                      | 1.5          | 1.30           | 8.3          |
| 1000           | 60    |      |                       | 6732912               | 162                      | 281                      | 305                      | 1.7          | 1.30           | 9.2          |
| 1100           | 60    |      |                       | 6732913               | 178                      | 309                      | 336                      | 1.9          | 1.30           | 10.0         |
| 1200           | 60    |      |                       | 6732914               | 194                      | 338                      | 366                      | 2.0          | 1.30           | 1.6          |
| 1400           | 60    |      | F061103014010300      | 6732915               | 226                      | 394                      | 427                      | 2.4          | 1.30           | 12.2         |
| 1600           | 60    |      | F061103016010300      | 6732916               | 259                      | 450                      | 488                      | 2.7          | 1.30           | 13.8         |
| 1800           | 60    |      |                       | 6732917               | 291                      | 506                      | 549                      | 3.1          | 1.30           | 15.4         |
| 2000           | 60    |      |                       | 6732918               | 323                      | 563                      | 610                      | 3.4          | 1.30           | 17.0         |
| 2300           | 60    |      |                       | 6732919               | 372                      | 647                      | 701                      | 3.9          | 1.30           | 19.4         |
| 2600           | 60    |      |                       | 6732920               | 420                      | 731                      | 793                      | 4.4          | 1.30           | 21.7         |
| 3000           | 60    |      |                       | 6732921               | 485                      | 844                      | 915                      | 5.1          | 1.30           | 24.9         |
| <b>Typ 21</b>  |       |      |                       |                       |                          |                          |                          |              |                |              |
| 400            | 70    |      |                       | 6733600               | 92                       | 158                      | 171                      | 1.4          | 1.28           | 6.2          |
| 500            | 70    |      |                       | 6733601               | 115                      | 198                      | 214                      | 1.7          | 1.28           | 7.4          |
| 600            | 70    |      |                       | 6733602               | 138                      | 237                      | 257                      | 2.0          | 1.28           | 8.6          |
| 700            | 70    |      | F062103007010300      | 6733603               | 160                      | 277                      | 300                      | 2.4          | 1.28           | 10.0         |
| 800            | 70    |      | F062103008010300      | 6733604               | 183                      | 317                      | 343                      | 2.7          | 1.28           | 11.3         |
| 900            | 70    |      |                       | 6733605               | 206                      | 356                      | 386                      | 3.1          | 1.28           | 12.3         |
| 1000           | 70    |      |                       | 6733606               | 229                      | 396                      | 428                      | 3.4          | 1.28           | 13.6         |



## 300

| HÖJD<br>300 mm | LÄNGD | DJUP | Artikelnr/<br>RSK (V) | Artikelnr/<br>RSK (H) | EFFEKT (W)<br>45/35/20°C | EFFEKT (W)<br>55/45/20°C | EFFEKT (W)<br>60/45/20°C | VOLYM<br>(l) | N-<br>EXPONENT | VIKT<br>(kg) |
|----------------|-------|------|-----------------------|-----------------------|--------------------------|--------------------------|--------------------------|--------------|----------------|--------------|
|                | 1100  | 70   | 6733607               |                       | 252                      | 435                      | 471                      | 3.7          | 1.28           | 14.8         |
|                | 1200  | 70   | 6733608               |                       | 275                      | 475                      | 514                      | 4.1          | 1.28           | 16.4         |
|                | 1400  | 70   | 6733609               |                       | 321                      | 554                      | 599                      | 4.8          | 1.28           | 18.7         |
|                | 1600  | 70   | 6733610               |                       | 367                      | 633                      | 686                      | 5.4          | 1.28           | 21.1         |
|                | 1800  | 70   | F062103018010300      | 6733611               | 412                      | 712                      | 771                      | 6.1          | 1.28           | 23.6         |
|                | 2000  | 70   | 6733612               |                       | 458                      | 791                      | 857                      | 6.8          | 1.28           | 26.1         |
|                | 2300  | 70   | 6733613               |                       | 527                      | 910                      | 985                      | 7.8          | 1.28           | 30.0         |
|                | 2600  | 70   | 6733614               |                       | 596                      | 1029                     | 1114                     | 8.8          | 1.28           | 33.7         |
|                | 3000  | 70   | 6733615               |                       | 687                      | 1187                     | 1285                     | 10.2         | 1.28           | 38.7         |
| <b>Typ 22</b>  |       |      |                       |                       |                          |                          |                          |              |                |              |
|                | 400   | 102  | 6733098               |                       | 112                      | 197                      | 213                      | 1.4          | 1.31           | 7.2          |
|                | 500   | 102  | 6733099               |                       | 141                      | 246                      | 267                      | 1.7          | 1.31           | 8.5          |
|                | 600   | 102  | 6733100               |                       | 169                      | 295                      | 321                      | 2.0          | 1.31           | 10.1         |
|                | 700   | 102  | 6733101               |                       | 197                      | 345                      | 374                      | 2.4          | 1.31           | 11.4         |
|                | 800   | 102  | 6733102               |                       | 225                      | 394                      | 427                      | 2.7          | 1.31           | 12.8         |
|                | 900   | 102  | 6733103               |                       | 253                      | 443                      | 481                      | 3.1          | 1.31           | 14.2         |
|                | 1000  | 102  | 6733104               |                       | 282                      | 492                      | 534                      | 3.4          | 1.31           | 15.6         |
|                | 1100  | 102  | 6733105               |                       | 310                      | 542                      | 587                      | 3.7          | 1.31           | 17.4         |
|                | 1200  | 102  | 6733106               |                       | 338                      | 591                      | 641                      | 4.1          | 1.31           | 18.5         |
|                | 1400  | 102  | 6733107               |                       | 394                      | 689                      | 747                      | 4.8          | 1.31           | 21.3         |
|                | 1600  | 102  | 6733108               |                       | 451                      | 788                      | 854                      | 5.4          | 1.31           | 24.2         |
|                | 1800  | 102  | 6733109               |                       | 507                      | 886                      | 961                      | 6.1          | 1.31           | 27.1         |
|                | 2000  | 102  | 6733110               |                       | 563                      | 985                      | 1068                     | 6.8          | 1.31           | 29.9         |
|                | 2300  | 102  | 6733111               |                       | 647                      | 1132                     | 1228                     | 7.8          | 1.31           | 34.1         |
|                | 2600  | 102  | F062203026010300      | 6733112               | 732                      | 1280                     | 1388                     | 8.8          | 1.31           | 38.5         |
|                | 3000  | 102  | 6733113               |                       | 845                      | 1477                     | 1602                     | 10.2         | 1.31           | 44.9         |



# 300

| HÖJD<br>300 mm | LÄNGD | DJUP             | Artikelnr/<br>RSK (V) | Artikelnr/<br>RSK (H) | EFFEKT (W)<br>45/35/20°C | EFFEKT (W)<br>55/45/20°C | EFFEKT (W)<br>60/45/20°C | VOLYM<br>(l) | N-<br>EXPONENT | VIKT<br>(kg) |
|----------------|-------|------------------|-----------------------|-----------------------|--------------------------|--------------------------|--------------------------|--------------|----------------|--------------|
| <b>Typ 33</b>  |       |                  |                       |                       |                          |                          |                          |              |                |              |
| 400            | 152   |                  | 6733194               |                       | 157                      | 275                      | 299                      | 2.0          | 1.31           | 1.3          |
| 500            | 152   |                  | 6733195               |                       | 197                      | 344                      | 374                      | 2.5          | 1.31           | 12.4         |
| 600            | 152   |                  | 6733196               |                       | 236                      | 413                      | 448                      | 3.1          | 1.31           | 14.5         |
| 700            | 152   |                  | 6733197               |                       | 275                      | 482                      | 523                      | 3.6          | 1.31           | 16.7         |
| 800            | 152   |                  | 6733198               |                       | 314                      | 551                      | 598                      | 4.1          | 1.31           | 18.8         |
| 900            | 152   |                  | 6733199               |                       | 353                      | 620                      | 672                      | 4.6          | 1.31           | 2.9          |
| 1000           | 152   |                  | 6733200               |                       | 393                      | 688                      | 747                      | 5.1          | 1.31           | 23.5         |
| 1100           | 152   |                  | 6733201               |                       | 432                      | 757                      | 822                      | 5.6          | 1.31           | 25.2         |
| 1200           | 152   |                  | 6733202               |                       | 471                      | 826                      | 896                      | 6.1          | 1.31           | 27.3         |
| 1400           | 152   |                  | 6733203               |                       | 550                      | 964                      | 1046                     | 7.1          | 1.31           | 31.6         |
| 1600           | 152   |                  | 6733204               |                       | 629                      | 1101                     | 1195                     | 8.2          | 1.31           | 35.8         |
| 1800           | 152   |                  | 6733205               |                       | 707                      | 1239                     | 1344                     | 9.2          | 1.31           | 4.7          |
| 2000           | 152   |                  | 6733206               |                       | 786                      | 1377                     | 1493                     | 10.2         | 1.31           | 44.3         |
| 2300           | 152   |                  | 6733207               |                       | 904                      | 1583                     | 1717                     | 11.7         | 1.31           | 5.7          |
| 2600           | 152   | F063303026010300 | 6733208               | 1022,1021             | 1790                     | 1941                     | 1941                     | 13.3         | 1.31           | 57.9         |
| 3000           | 152   |                  | 6733209               |                       | 1179                     | 2065                     | 2240                     | 15.3         | 1.31           | 65.6         |



## 400

| HÖJD<br>400 mm | LÄNGD | DJUP             | Artikelnr/<br>RSK (V) | Artikelnr/<br>RSK (H) | EFFEKT (W)<br>45/35/20°C | EFFEKT (W)<br>55/45/20°C | EFFEKT (W)<br>60/45/20°C | VOLYM<br>(l) | N-<br>EXPONENT | VIKT<br>(kg) |
|----------------|-------|------------------|-----------------------|-----------------------|--------------------------|--------------------------|--------------------------|--------------|----------------|--------------|
| <b>Typ 11</b>  |       |                  |                       |                       |                          |                          |                          |              |                |              |
| 400            | 60    |                  | 6732922               |                       | 84                       | 146                      | 158                      | 0.9          | 1.30           | 5.5          |
| 500            | 60    |                  | 6732923               |                       | 105                      | 183                      | 198                      | 1.1          | 1.30           | 6.5          |
| 600            | 60    |                  | 6732924               |                       | 126                      | 219                      | 238                      | 1.3          | 1.30           | 7.6          |
| 700            | 60    |                  | 6732925               |                       | 147                      | 256                      | 277                      | 1.5          | 1.30           | 8.7          |
| 800            | 60    |                  | 6732926               |                       | 168                      | 292                      | 317                      | 1.8          | 1.30           | 9.7          |
| 900            | 60    |                  | 6732927               |                       | 189                      | 329                      | 357                      | 2.0          | 1.30           | 18           |
| 1000           | 60    |                  | 6732928               |                       | 210                      | 366                      | 396                      | 2.2          | 1.30           | 11.8         |
| 1100           | 60    |                  | 6732929               |                       | 231                      | 402                      | 436                      | 2.4          | 1.30           | 12.9         |
| 1200           | 60    |                  | 6732930               |                       | 251                      | 439                      | 475                      | 2.6          | 1.30           | 14.0         |
| 1400           | 60    | F061104014010300 | 6732931               |                       | 294,293                  | 512                      | 555,554                  | 3.1          | 1.30           | 16.1         |
| 1600           | 60    |                  | 6732932               |                       | 335                      | 585                      | 634                      | 3.5          | 1.30           | 18.2         |
| 1800           | 60    |                  | 6732933               |                       | 377                      | 658                      | 713                      | 4.0          | 1.30           | 2.4          |
| 2000           | 60    |                  | 6732934               |                       | 419                      | 731                      | 792                      | 4.4          | 1.30           | 22.5         |
| 2300           | 60    |                  | 6732935               |                       | 482                      | 841                      | 911                      | 5.1          | 1.30           | 25.7         |
| 2600           | 60    |                  | 6732936               |                       | 545                      | 950                      | 1030                     | 5.7          | 1.30           | 28.9         |
| 3000           | 60    |                  | 6732937               |                       | 629                      | 1097                     | 1189                     | 6.6          | 1.30           | 33.2         |
| <b>Typ 21</b>  |       |                  |                       |                       |                          |                          |                          |              |                |              |
| 400            | 70    |                  | 6733616               |                       | 114                      | 199                      | 215                      | 1.8          | 1.29           | 7.7          |
| 500            | 70    |                  | 6733617               |                       | 143                      | 249                      | 270                      | 2.3          | 1.29           | 9.4          |
| 600            | 70    |                  | 6733618               |                       | 172                      | 298                      | 323                      | 2.7          | 1.29           | 11.1         |
| 700            | 70    |                  | 6733619               |                       | 200                      | 348                      | 377                      | 3.1          | 1.29           | 12.8         |
| 800            | 70    |                  | 6733620               |                       | 229                      | 398                      | 431                      | 3.6          | 1.29           | 14.5         |
| 900            | 70    |                  | 6733621               |                       | 258                      | 448                      | 485                      | 4.0          | 1.29           | 16.2         |
| 1000           | 70    |                  | 6733622               |                       | 286                      | 497                      | 539                      | 4.5          | 1.29           | 17.9         |
| 1100           | 70    |                  | 6733623               |                       | 315                      | 547                      | 592                      | 5.0          | 1.29           | 19.6         |



## 400

| HÖJD<br>400 mm | LÄNGD | DJUP | Artikelnr/<br>RSK (V) | Artikelnr/<br>RSK (H) | EFFEKT (W)<br>45/35/20°C | EFFEKT (W)<br>55/45/20°C | EFFEKT (W)<br>60/45/20°C | VOLYM<br>(l) | N-<br>EXPONENT | VIKT<br>(kg) |
|----------------|-------|------|-----------------------|-----------------------|--------------------------|--------------------------|--------------------------|--------------|----------------|--------------|
|                | 1200  | 70   | F062104012010300      | 6733624               | 344                      | 597                      | 647,646                  | 5.4          | 1.29           | 21.3         |
|                | 1400  | 70   |                       | 6733625               | 401                      | 696                      | 754                      | 6.3          | 1.29           | 24.6         |
|                | 1600  | 70   |                       | 6733626               | 458                      | 796                      | 862                      | 7.2          | 1.29           | 28.3         |
|                | 1800  | 70   |                       | 6733627               | 515                      | 895                      | 969                      | 8.1          | 1.29           | 31.4         |
|                | 2000  | 70   | F062104020010300      | 6733628               | 573,572                  | 994                      | 1077                     | 9.0          | 1.29           | 34.8         |
|                | 2300  | 70   | F062104023010300      | 6733629               | 658                      | 1144                     | 1239                     | 10.3         | 1.29           | 39.9         |
|                | 2600  | 70   | F062104026010300      | 6733630               | 744                      | 1293                     | 1401,1400                | 11.7         | 1.29           | 44.9         |
|                | 3000  | 70   |                       | 6733631               | 859                      | 1492                     | 1616                     | 13.5         | 1.29           | 51.7         |
| <b>Typ 22</b>  |       |      |                       |                       |                          |                          |                          |              |                |              |
|                | 400   | 102  |                       | 6733114               | 142                      | 249                      | 270                      | 1.8          | 1.32           | 9.2          |
|                | 500   | 102  |                       | 6733115               | 178                      | 311                      | 338                      | 2.3          | 1.32           | 11.3         |
|                | 600   | 102  |                       | 6733116               | 213                      | 374                      | 406                      | 2.7          | 1.32           | 13.3         |
|                | 700   | 102  |                       | 6733117               | 248                      | 436                      | 473                      | 3.1          | 1.32           | 15.0         |
|                | 800   | 102  |                       | 6733118               | 284                      | 498                      | 541                      | 3.6          | 1.32           | 16.9         |
|                | 900   | 102  |                       | 6733119               | 319                      | 560                      | 608                      | 4.0          | 1.32           | 18.8         |
|                | 1000  | 102  |                       | 6733120               | 355                      | 623                      | 676                      | 4.5          | 1.32           | 2.7          |
|                | 1100  | 102  |                       | 6733121               | 390                      | 685                      | 743                      | 5.0          | 1.32           | 22.6         |
|                | 1200  | 102  |                       | 6733122               | 426                      | 747                      | 811                      | 5.4          | 1.32           | 24.6         |
|                | 1400  | 102  | F062204014010300      | 6733123               | 497,496                  | 872                      | 946                      | 6.3          | 1.32           | 28.4         |
|                | 1600  | 102  |                       | 6733124               | 568                      | 996                      | 1081                     | 7.2          | 1.32           | 32.3         |
|                | 1800  | 102  |                       | 6733125               | 639                      | 1121                     | 1216                     | 8.1          | 1.32           | 36.1         |
|                | 2000  | 102  |                       | 6733126               | 709                      | 1245                     | 1351                     | 9.0          | 1.32           | 40.0         |
|                | 2300  | 102  |                       | 6733127               | 816                      | 1432                     | 1554                     | 10.3         | 1.32           | 45.7         |
|                | 2600  | 102  |                       | 6733128               | 922                      | 1619                     | 1757                     | 11.7         | 1.32           | 51.6         |
|                | 3000  | 102  |                       | 6733129               | 1064                     | 1868                     | 2027                     | 13.5         | 1.32           | 59.2         |

## Typ 33



## 400

| HÖJD<br>400 mm | LÄNGD | DJUP | Artikelnr/<br>RSK (V) | Artikelnr/<br>RSK (H) | EFFEKT (W)<br>45/35/20°C | EFFEKT (W)<br>55/45/20°C | EFFEKT (W)<br>60/45/20°C | VOLYM<br>(l) | N-<br>EXPONENT | VIKT<br>(kg) |
|----------------|-------|------|-----------------------|-----------------------|--------------------------|--------------------------|--------------------------|--------------|----------------|--------------|
|                | 400   | 152  |                       | 6733210               | 196                      | 345                      | 375                      | 2.7          | 1.33           | 13.5         |
|                | 500   | 152  |                       | 6733211               | 245                      | 432                      | 469                      | 3.4          | 1.33           | 16.4         |
|                | 600   | 152  |                       | 6733212               | 294                      | 518                      | 562                      | 4.0          | 1.33           | 19.2         |
|                | 700   | 152  |                       | 6733213               | 343                      | 604                      | 656                      | 4.7          | 1.33           | 22.1         |
|                | 800   | 152  |                       | 6733214               | 392                      | 691                      | 750                      | 5.4          | 1.33           | 25.0         |
|                | 900   | 152  |                       | 6733215               | 441                      | 777                      | 843                      | 6.0          | 1.33           | 27.9         |
|                | 1000  | 152  | F063304010010300      | 6733216               | 490                      | 863                      | 937                      | 6.7          | 1.33           | 3.8          |
|                | 1100  | 152  |                       | 6733217               | 539                      | 950                      | 1031                     | 7.4          | 1.33           | 33.6         |
|                | 1200  | 152  |                       | 6733218               | 588                      | 1036                     | 1125                     | 8.0          | 1.33           | 36.5         |
|                | 1400  | 152  | F063304014010300      | 6733219               | 686                      | 1209                     | 1312                     | 9.4          | 1.33           | 42.3         |
|                | 1600  | 152  |                       | 6733220               | 784                      | 1381                     | 1499                     | 10.7         | 1.33           | 48.5         |
|                | 1800  | 152  |                       | 6733221               | 882                      | 1554                     | 1687                     | 12.1         | 1.33           | 53.9         |
|                | 2000  | 152  |                       | 6733222               | 980                      | 1726                     | 1874                     | 13.4         | 1.33           | 59.6         |
|                | 2300  | 152  |                       | 6733223               | 1128                     | 1985                     | 2155                     | 15.4         | 1.33           | 68.2         |
|                | 2600  | 152  |                       | 6733224               | 1274                     | 2244                     | 2436                     | 17.4         | 1.33           | 76.9         |
|                | 3000  | 152  |                       | 6733225               | 1471                     | 2590                     | 2811                     | 20.1         | 1.33           | 88.4         |



## 450

| HÖJD<br>450 mm | LÄNGD | DJUP | Artikelnr/<br>RSK (V) | Artikelnr/<br>RSK (H) | EFFEKT (W)<br>45/35/20°C | EFFEKT (W)<br>55/45/20°C | EFFEKT (W)<br>60/45/20°C | VOLYM<br>(l) | N-<br>EXPONENT | VIKT<br>(kg) |
|----------------|-------|------|-----------------------|-----------------------|--------------------------|--------------------------|--------------------------|--------------|----------------|--------------|
| <b>Typ 11</b>  |       |      |                       |                       |                          |                          |                          |              |                |              |
| 400            | 60    |      | F061104504010300      | 6732938               | 93                       | 162                      | 176                      | 1.0          | 1.30           | 6.4          |
| 500            | 60    |      |                       | 6732939               | 116                      | 203                      | 220                      | 1.3          | 1.30           | 7.6          |
| 600            | 60    |      |                       | 6732940               | 139                      | 243                      | 264                      | 1.5          | 1.30           | 8.9          |
| 700            | 60    |      | F061104507010300      | 6732941               | 163                      | 284                      | 308                      | 1.8          | 1.30           | 1.2          |
| 800            | 60    |      |                       | 6732942               | 186                      | 325                      | 352                      | 2.0          | 1.30           | 11.4         |
| 900            | 60    |      |                       | 6732943               | 209                      | 365                      | 396                      | 2.3          | 1.30           | 12.7         |
| 1000           | 60    |      |                       | 6732944               | 232                      | 406                      | 440                      | 2.5          | 1.30           | 14.0         |
| 1100           | 60    |      |                       | 6732945               | 256                      | 446                      | 484                      | 2.8          | 1.30           | 15.2         |
| 1200           | 60    |      | F061104512010300      | 6732946               | 279                      | 487                      | 528                      | 3.0          | 1.30           | 16.5         |
| 1400           | 60    |      | F061104514010300      | 6732947               | 325                      | 568                      | 616                      | 3.5          | 1.30           | 19.4         |
| 1600           | 60    |      |                       | 6732948               | 372                      | 649                      | 704                      | 4.0          | 1.30           | 21.5         |
| 1800           | 60    |      | F061104518010300      | 6732949               | 418                      | 730                      | 792,791                  | 4.5          | 1.30           | 24.5         |
| 2000           | 60    |      |                       | 6732950               | 465                      | 811                      | 880                      | 5.0          | 1.30           | 26.6         |
| 2300           | 60    |      |                       | 6732951               | 535                      | 933                      | 1011                     | 5.8          | 1.30           | 3.4          |
| 2600           | 60    |      |                       | 6732952               | 604                      | 1055                     | 1143                     | 6.5          | 1.30           | 34.2         |
| 3000           | 60    |      |                       | 6732953               | 697                      | 1217                     | 1319                     | 7.5          | 1.30           | 39.2         |
| <b>Typ 21</b>  |       |      |                       |                       |                          |                          |                          |              |                |              |
| 400            | 70    |      |                       | 6733632               | 125                      | 218                      | 236                      | 2.0          | 1.30           | 9.3          |
| 500            | 70    |      |                       | 6733633               | 157                      | 273                      | 296                      | 2.5          | 1.30           | 11.3         |
| 600            | 70    |      |                       | 6733634               | 188                      | 327                      | 355                      | 3.0          | 1.30           | 13.4         |
| 700            | 70    |      | F062104507010300      | 6733635               | 219                      | 382                      | 414                      | 3.5          | 1.30           | 15.4         |
| 800            | 70    |      |                       | 6733636               | 250                      | 436                      | 473                      | 4.0          | 1.30           | 17.4         |
| 900            | 70    |      | F062104509010300      | 6733637               | 282                      | 491                      | 532                      | 4.5          | 1.30           | 19.4         |
| 1000           | 70    |      |                       | 6733638               | 313                      | 545                      | 591                      | 5.0          | 1.30           | 21.4         |
| 1100           | 70    |      |                       | 6733639               | 344                      | 600                      | 650                      | 5.5          | 1.30           | 23.5         |



## 450

| HÖJD<br>450 mm | LÄNGD | DJUP | Artikelnr/<br>RSK (V) | Artikelnr/<br>RSK (H) | EFFEKT (W)<br>45/35/20°C | EFFEKT (W)<br>55/45/20°C | EFFEKT (W)<br>60/45/20°C | VOLYM<br>(l) | N-<br>EXPONENT | VIKT<br>(kg) |
|----------------|-------|------|-----------------------|-----------------------|--------------------------|--------------------------|--------------------------|--------------|----------------|--------------|
|                | 1200  | 70   | 6733640               |                       | 376                      | 654                      | 709                      | 6.0          | 1.30           | 25.5         |
|                | 1400  | 70   | 6733641               |                       | 438                      | 764                      | 828                      | 7.0          | 1.30           | 29.5         |
|                | 1600  | 70   | 6733642               |                       | 501                      | 873                      | 946                      | 8.0          | 1.30           | 33.6         |
|                | 1800  | 70   | F062104518010300      | 6733643               | 564,563                  | 982                      | 1064                     | 9.0          | 1.30           | 37.7         |
|                | 2000  | 70   | 6733644               |                       | 626                      | 1091                     | 1182                     | 10.0         | 1.30           | 41.6         |
|                | 2300  | 70   | 6733645               |                       | 720                      | 1254                     | 1360                     | 11.5         | 1.30           | 47.7         |
|                | 2600  | 70   | 6733646               |                       | 814                      | 1418                     | 1537                     | 13.0         | 1.30           | 53.8         |
|                | 3000  | 70   | 6733647               |                       | 939                      | 1636                     | 1773                     | 15.0         | 1.30           | 61.9         |
| <b>Typ 22</b>  |       |      |                       |                       |                          |                          |                          |              |                |              |
|                | 400   | 102  | 6733130               |                       | 156                      | 274                      | 298                      | 2.0          | 1.32           | 1.6          |
|                | 500   | 102  | 6733131               |                       | 195                      | 343                      | 372                      | 2.5          | 1.32           | 13.0         |
|                | 600   | 102  | 6733132               |                       | 234                      | 411                      | 446                      | 3.0          | 1.32           | 15.3         |
|                | 700   | 102  | 6733133               |                       | 273                      | 480                      | 521                      | 3.5          | 1.32           | 17.6         |
|                | 800   | 102  | 6733134               |                       | 312                      | 548                      | 595                      | 4.0          | 1.32           | 19.9         |
|                | 900   | 102  | 6733135               |                       | 351                      | 617                      | 669                      | 4.5          | 1.32           | 22.2         |
|                | 1000  | 102  | 6733136               |                       | 390                      | 685                      | 744                      | 5.0          | 1.32           | 24.5         |
|                | 1100  | 102  | 6733137               |                       | 429                      | 754                      | 818                      | 5.5          | 1.32           | 26.8         |
|                | 1200  | 102  | 6733138               |                       | 468                      | 822                      | 892                      | 6.0          | 1.32           | 29.1         |
|                | 1400  | 102  | 6733139               |                       | 546                      | 960                      | 1042                     | 7.0          | 1.32           | 33.7         |
|                | 1600  | 102  | 6733140               |                       | 623                      | 1097                     | 1190                     | 8.0          | 1.32           | 38.3         |
|                | 1800  | 102  | 6733141               |                       | 702                      | 1234                     | 1339                     | 9.0          | 1.32           | 43.0         |
|                | 2000  | 102  | 6733142               |                       | 779                      | 1371                     | 1488                     | 10.0         | 1.32           | 47.6         |
|                | 2300  | 102  | 6733143               |                       | 896                      | 1576                     | 1711                     | 11.5         | 1.32           | 54.5         |
|                | 2600  | 102  | 6733144               |                       | 1013                     | 1782                     | 1934                     | 13.0         | 1.32           | 61.4         |
|                | 3000  | 102  | 6733145               |                       | 1169                     | 2056                     | 2232                     | 15.0         | 1.32           | 7.6          |

**Typ 33**



## 450

| HÖJD<br>450 mm | LÄNGD | DJUP | Artikelnr/<br>RSK (V) | Artikelnr/<br>RSK (H) | EFFEKT (W)<br>45/35/20°C | EFFEKT (W)<br>55/45/20°C | EFFEKT (W)<br>60/45/20°C | VOLYM<br>(l) | N-<br>EXPONENT | VIKT<br>(kg) |
|----------------|-------|------|-----------------------|-----------------------|--------------------------|--------------------------|--------------------------|--------------|----------------|--------------|
|                | 400   | 152  | 6733226               |                       | 215                      | 379                      | 411                      | 3.0          | 1.33           | 15.8         |
|                | 500   | 152  | 6733227               |                       | 268                      | 473                      | 514                      | 3.8          | 1.33           | 19.2         |
|                | 600   | 152  | 6733228               |                       | 322                      | 568                      | 617                      | 4.5          | 1.33           | 22.7         |
|                | 700   | 152  | F063304507010300      | 6733229               | 376,375                  | 663                      | 720,719                  | 5.3          | 1.33           | 26.1         |
|                | 800   | 152  | F063304508010300      | 6733230               | 429                      | 757                      | 822                      | 6.0          | 1.33           | 29.6         |
|                | 900   | 152  | 6733231               |                       | 483                      | 852                      | 925                      | 6.8          | 1.33           | 33.7         |
|                | 1000  | 152  | 6733232               |                       | 536                      | 947                      | 1028                     | 7.5          | 1.33           | 36.5         |
|                | 1100  | 152  | 6733233               |                       | 590                      | 1041                     | 1131                     | 8.3          | 1.33           | 39.9         |
|                | 1200  | 152  | 6733234               |                       | 644                      | 1136                     | 1234                     | 9.0          | 1.33           | 43.3         |
|                | 1400  | 152  | F063304514010300      | 6733235               | 751                      | 1326                     | 1440,1439                | 10.5         | 1.33           | 5.2          |
|                | 1600  | 152  | F063304516010300      | 6733236               | 858                      | 1515                     | 1645                     | 12.0         | 1.33           | 57.1         |
|                | 1800  | 152  | 6733237               |                       | 965                      | 1704                     | 1850                     | 13.5         | 1.33           | 64.1         |
|                | 2000  | 152  | 6733238               |                       | 1073                     | 1894                     | 2056                     | 15.0         | 1.33           | 79           |
|                | 2300  | 152  | F063304523010300      | 6733239               | 1234                     | 2178                     | 2365,2364                | 17.3         | 1.33           | 81.2         |
|                | 2600  | 152  | 6733240               |                       | 1394                     | 2462                     | 2673                     | 19.5         | 1.33           | 91.6         |
|                | 3000  | 152  | 6733241               |                       | 1609                     | 2840                     | 3084                     | 22.5         | 1.33           | 107.4        |



## 500

| HÖJD<br>500 mm | LÄNGD | DJUP | Artikelnr/<br>RSK (V) | Artikelnr/<br>RSK (H) | EFFEKT (W)<br>45/35/20°C | EFFEKT (W)<br>55/45/20°C | EFFEKT (W)<br>60/45/20°C | VOLYM<br>(l) | N-<br>EXPONENT | VIKT<br>(kg) |
|----------------|-------|------|-----------------------|-----------------------|--------------------------|--------------------------|--------------------------|--------------|----------------|--------------|
| <b>Typ 11</b>  |       |      |                       |                       |                          |                          |                          |              |                |              |
|                | 400   | 60   |                       | 6732954               | 102                      | 178                      | 193                      | 1.1          | 1.31           | 6.5          |
|                | 500   | 60   |                       | 6732955               | 127                      | 223                      | 241                      | 1.4          | 1.31           | 7.8          |
|                | 600   | 60   |                       | 6732956               | 153                      | 267                      | 290                      | 1.6          | 1.31           | 9.2          |
|                | 700   | 60   |                       | 6732957               | 178                      | 312                      | 338                      | 1.9          | 1.31           | 1.6          |
|                | 800   | 60   |                       | 6732958               | 204                      | 356                      | 386                      | 2.2          | 1.31           | 12.0         |
|                | 900   | 60   |                       | 6732959               | 229                      | 401                      | 434                      | 2.4          | 1.31           | 13.3         |
|                | 1000  | 60   |                       | 6732960               | 255                      | 445                      | 483                      | 2.7          | 1.31           | 14.8         |
|                | 1100  | 60   |                       | 6732961               | 280                      | 490                      | 531                      | 3.0          | 1.31           | 16.4         |
|                | 1200  | 60   | F061105012010300      | 6732962               | 306                      | 534                      | 579                      | 3.2          | 1.31           | 17.5         |
|                | 1400  | 60   |                       | 6732963               | 357                      | 623                      | 676                      | 3.8          | 1.31           | 2.2          |
|                | 1600  | 60   |                       | 6732964               | 408                      | 712                      | 772                      | 4.3          | 1.31           | 22.9         |
|                | 1800  | 60   |                       | 6732965               | 459                      | 801                      | 869                      | 4.9          | 1.31           | 25.7         |
|                | 2000  | 60   |                       | 6732966               | 510                      | 890                      | 965                      | 5.4          | 1.31           | 28.4         |
|                | 2300  | 60   |                       | 6732967               | 586                      | 1024                     | 1110                     | 6.2          | 1.31           | 32.6         |
|                | 2600  | 60   |                       | 6732968               | 663                      | 1158                     | 1255                     | 7.0          | 1.31           | 36.7         |
|                | 3000  | 60   |                       | 6732969               | 764                      | 1336                     | 1448                     | 8.1          | 1.31           | 43.0         |
| <b>Typ 21</b>  |       |      |                       |                       |                          |                          |                          |              |                |              |
|                | 400   | 70   | F062105004010300      | 6733648               | 136                      | 237                      | 257                      | 2.2          | 1.31           | 9.6          |
|                | 500   | 70   |                       | 6733649               | 170                      | 296                      | 321                      | 2.8          | 1.31           | 11.7         |
|                | 600   | 70   |                       | 6733650               | 204                      | 356                      | 386                      | 3.3          | 1.31           | 13.8         |
|                | 700   | 70   | F062105007010300      | 6733651               | 237                      | 415                      | 450                      | 3.9          | 1.31           | 15.9         |
|                | 800   | 70   |                       | 6733652               | 271                      | 474                      | 514                      | 4.4          | 1.31           | 18.1         |
|                | 900   | 70   |                       | 6733653               | 305                      | 533                      | 578                      | 5.0          | 1.31           | 2.1          |
|                | 1000  | 70   |                       | 6733654               | 339                      | 593                      | 643                      | 5.5          | 1.31           | 22.2         |
|                | 1100  | 70   |                       | 6733655               | 373                      | 652                      | 707                      | 6.0          | 1.31           | 24.3         |



## 500

| HÖJD<br>500 mm | LÄNGD | DJUP | Artikelnr/<br>RSK (V) | Artikelnr/<br>RSK (H) | EFFEKT (W)<br>45/35/20°C | EFFEKT (W)<br>55/45/20°C | EFFEKT (W)<br>60/45/20°C | VOLYM<br>(l) | N-<br>EXPONENT | VIKT<br>(kg) |
|----------------|-------|------|-----------------------|-----------------------|--------------------------|--------------------------|--------------------------|--------------|----------------|--------------|
|                | 1200  | 70   | 6733656               |                       | 407                      | 711                      | 771                      | 6.6          | 1.31           | 26.4         |
|                | 1400  | 70   | 6733657               |                       | 475                      | 830                      | 900                      | 7.7          | 1.31           | 3.5          |
|                | 1600  | 70   | 6733658               |                       | 543                      | 948                      | 1029                     | 8.8          | 1.31           | 34.7         |
|                | 1800  | 70   | 6733659               |                       | 611                      | 1067                     | 1157                     | 9.9          | 1.31           | 38.9         |
|                | 2000  | 70   | 6733660               |                       | 678                      | 1185                     | 1285                     | 11.0         | 1.31           | 43.9         |
|                | 2300  | 70   | 6733661               |                       | 780                      | 1363                     | 1478                     | 12.7         | 1.31           | 49.4         |
|                | 2600  | 70   | 6733662               |                       | 882                      | 1541                     | 1671                     | 14.3         | 1.31           | 55.6         |
|                | 3000  | 70   | 6733663               |                       | 1018                     | 1778                     | 1928                     | 16.5         | 1.31           | 64.0         |
| <b>Typ 22</b>  |       |      |                       |                       |                          |                          |                          |              |                |              |
|                | 400   | 102  | F062205004010300      | 6733146               | 169                      | 299                      | 324                      | 2.2          | 1.33           | 11.2         |
|                | 500   | 102  |                       | 6733147               | 212                      | 373                      | 405                      | 2.8          | 1.33           | 13.7         |
|                | 600   | 102  |                       | 6733148               | 254                      | 448                      | 486                      | 3.3          | 1.33           | 16.4         |
|                | 700   | 102  |                       | 6733149               | 296                      | 522                      | 567                      | 3.9          | 1.33           | 18.6         |
|                | 800   | 102  | F062205008010300      | 6733150               | 339                      | 597                      | 648                      | 4.4          | 1.33           | 2.9          |
|                | 900   | 102  |                       | 6733151               | 381                      | 672                      | 729                      | 5.0          | 1.33           | 23.4         |
|                | 1000  | 102  |                       | 6733152               | 424                      | 746                      | 810                      | 5.5          | 1.33           | 25.8         |
|                | 1100  | 102  |                       | 6733153               | 466                      | 821                      | 891                      | 6.0          | 1.33           | 28.3         |
|                | 1200  | 102  |                       | 6733154               | 508                      | 896                      | 972                      | 6.6          | 1.33           | 3.6          |
|                | 1400  | 102  |                       | 6733155               | 593                      | 1045                     | 1134                     | 7.7          | 1.33           | 35.5         |
|                | 1600  | 102  |                       | 6733156               | 678                      | 1194                     | 1296                     | 8.8          | 1.33           | 4.3          |
|                | 1800  | 102  |                       | 6733157               | 762                      | 1343                     | 1458                     | 9.9          | 1.33           | 45.2         |
|                | 2000  | 102  |                       | 6733158               | 847                      | 1493                     | 1620                     | 11.0         | 1.33           | 5.1          |
|                | 2300  | 102  |                       | 6733159               | 974                      | 1717                     | 1863                     | 12.7         | 1.33           | 57.3         |
|                | 2600  | 102  |                       | 6733160               | 1101                     | 1940                     | 2106                     | 14.3         | 1.33           | 64.6         |
|                | 3000  | 102  |                       | 6733161               | 1271                     | 2239                     | 2431                     | 16.5         | 1.33           | 74.3         |

## Typ 33



## 500

| HÖJD<br>500 mm | LÄNGD | DJUP | Artikelnr/<br>RSK (V) | Artikelnr/<br>RSK (H) | EFFEKT (W)<br>45/35/20°C | EFFEKT (W)<br>55/45/20°C | EFFEKT (W)<br>60/45/20°C | VOLYM<br>(l) | N-<br>EXPONENT | VIKT<br>(kg) |
|----------------|-------|------|-----------------------|-----------------------|--------------------------|--------------------------|--------------------------|--------------|----------------|--------------|
|                | 400   | 152  |                       | 6733242               | 232                      | 411                      | 447                      | 3.3          | 1.34           | 16.6         |
|                | 500   | 152  |                       | 6733243               | 291                      | 514                      | 559                      | 4.1          | 1.34           | 2.2          |
|                | 600   | 152  | F063305006010300      | 6733244               | 349,348                  | 617                      | 670                      | 4.9          | 1.34           | 23.9         |
|                | 700   | 152  |                       | 6733245               | 407                      | 719                      | 782                      | 5.7          | 1.34           | 27.6         |
|                | 800   | 152  |                       | 6733246               | 465                      | 822                      | 893                      | 6.6          | 1.34           | 31.1         |
|                | 900   | 152  |                       | 6733247               | 523                      | 925                      | 1005                     | 7.4          | 1.34           | 34.8         |
|                | 1000  | 152  |                       | 6733248               | 581                      | 1028                     | 1116                     | 8.2          | 1.34           | 38.5         |
|                | 1100  | 152  | F063305011010300      | 6733249               | 639                      | 1131                     | 1228                     | 9.0          | 1.34           | 42.4         |
|                | 1200  | 152  |                       | 6733250               | 697                      | 1233                     | 1340                     | 9.8          | 1.34           | 45.7         |
|                | 1400  | 152  |                       | 6733251               | 813                      | 1439                     | 1563                     | 11.5         | 1.34           | 52.9         |
|                | 1600  | 152  |                       | 6733252               | 929                      | 1645                     | 1786                     | 13.1         | 1.34           | 6.2          |
|                | 1800  | 152  |                       | 6733253               | 1045                     | 1850                     | 2010                     | 14.8         | 1.34           | 67.5         |
|                | 2000  | 152  |                       | 6733254               | 1162                     | 2056                     | 2233                     | 16.4         | 1.34           | 74.7         |
|                | 2300  | 152  |                       | 6733255               | 1336                     | 2364                     | 2568                     | 18.9         | 1.34           | 85.6         |
|                | 2600  | 152  |                       | 6733256               | 1510                     | 2672                     | 2903                     | 21.3         | 1.34           | 96.6         |
|                | 3000  | 152  |                       | 6733257               | 1742                     | 3084                     | 3349                     | 24.6         | 1.34           | 111.9        |



# 550

| HÖJD<br>550 mm | LÄNGD | DJUP | Artikelnr/<br>RSK | EFFEKT (W)<br>45/35/20°C | EFFEKT (W)<br>55/45/20°C | EFFEKT (W)<br>60/45/20°C | VOLYM<br>(l) | N-<br>EXPONENT | VIKT<br>(kg) |
|----------------|-------|------|-------------------|--------------------------|--------------------------|--------------------------|--------------|----------------|--------------|
| <b>Typ 22</b>  |       |      |                   |                          |                          |                          |              |                |              |
|                | 800   | 102  | F062205508010300  | 365                      | 645                      | 700                      | 4.9          | 1.33           | 23.2         |
|                | 1100  | 102  | F062205511010300  | 502                      | 887                      | 962                      | 6.7          | 1.33           | 31.5         |
|                | 2300  | 102  | F062205523010300  | 1050                     | 1854                     | 2012                     | 14.0         | 1.33           | 64.6         |
|                | 3000  | 102  | F062205530010300  | 1370                     | 2418                     | 2625                     | 18.3         | 1.33           | 83.9         |
| <b>Typ 33</b>  |       |      |                   |                          |                          |                          |              |                |              |
|                | 3000  | 152  | F063305530010300  | 1872                     | 3319                     | 3606                     | 27.0         | 1.34           | 123.6        |



## 600

| HÖJD<br>600 mm | LÄNGD | DJUP | Artikelnr/<br>RSK (V) | Artikelnr/<br>RSK (H) | EFFEKT (W)<br>45/35/20°C | EFFEKT (W)<br>55/45/20°C | EFFEKT (W)<br>60/45/20°C | VOLYM<br>(l) | N-<br>EXPONENT | VIKT<br>(kg) |
|----------------|-------|------|-----------------------|-----------------------|--------------------------|--------------------------|--------------------------|--------------|----------------|--------------|
| <b>Typ 11</b>  |       |      |                       |                       |                          |                          |                          |              |                |              |
| 400            | 60    |      | F061106004010300      | 6732970               | 119                      | 208                      | 226                      | 1.3          | 1.31           | 7.9          |
| 500            | 60    |      | F061106005010300      | 6732971               | 149                      | 260                      | 282                      | 1.6          | 1.31           | 9.5          |
| 600            | 60    |      | F061106006010300      | 6732972               | 179                      | 313                      | 339                      | 1.9          | 1.31           | 11.1         |
| 700            | 60    |      |                       | 6732973               | 208                      | 365                      | 396                      | 2.2          | 1.31           | 12.7         |
| 800            | 60    |      |                       | 6732974               | 238                      | 417                      | 452                      | 2.6          | 1.31           | 14.4         |
| 900            | 60    |      |                       | 6732975               | 268                      | 469                      | 508                      | 2.9          | 1.31           | 16.0         |
| 1000           | 60    |      |                       | 6732976               | 298                      | 521                      | 565                      | 3.2          | 1.31           | 17.6         |
| 1100           | 60    |      |                       | 6732977               | 327                      | 573                      | 622                      | 3.5          | 1.31           | 19.2         |
| 1200           | 60    |      |                       | 6732978               | 357                      | 625                      | 678                      | 3.8          | 1.31           | 2.9          |
| 1400           | 60    |      |                       | 6732979               | 417                      | 729                      | 791                      | 4.5          | 1.31           | 24.4         |
| 1600           | 60    |      |                       | 6732980               | 476                      | 834                      | 904                      | 5.1          | 1.31           | 27.3         |
| 1800           | 60    |      |                       | 6732981               | 536                      | 938                      | 1017                     | 5.8          | 1.31           | 3.5          |
| 2000           | 60    |      | F061106020010300      | 6732982               | 595                      | 1042                     | 1130                     | 6.4          | 1.31           | 33.7         |
| 2300           | 60    |      |                       | 6732983               | 684                      | 1198                     | 1299                     | 7.4          | 1.31           | 38.6         |
| 2600           | 60    |      |                       | 6732984               | 774                      | 1354                     | 1469                     | 8.3          | 1.31           | 43.4         |
| 3000           | 60    |      |                       | 6732985               | 893                      | 1563                     | 1695                     | 9.6          | 1.31           | 49.8         |
| <b>Typ 21</b>  |       |      |                       |                       |                          |                          |                          |              |                |              |
| 400            | 70    |      |                       | 6733664               | 155                      | 273                      | 296                      | 2.6          | 1.32           | 11.5         |
| 500            | 70    |      |                       | 6733665               | 194                      | 341                      | 370                      | 3.3          | 1.32           | 14.4         |
| 600            | 70    |      |                       | 6733666               | 233                      | 409                      | 444                      | 4.0          | 1.32           | 16.6         |
| 700            | 70    |      |                       | 6733667               | 272                      | 478                      | 518                      | 4.6          | 1.32           | 19.2         |
| 800            | 70    |      |                       | 6733668               | 311                      | 546                      | 592                      | 5.3          | 1.32           | 21.7         |
| 900            | 70    |      |                       | 6733669               | 349                      | 614                      | 666                      | 5.9          | 1.32           | 24.3         |
| 1000           | 70    |      |                       | 6733670               | 388                      | 682                      | 740                      | 6.6          | 1.32           | 26.8         |
| 1100           | 70    |      |                       | 6733671               | 427                      | 751                      | 814                      | 7.3          | 1.32           | 29.4         |



## 600

| HÖJD<br>600 mm | LÄNGD | DJUP | Artikelnr/<br>RSK (V) | Artikelnr/<br>RSK (H) | EFFEKT (W)<br>45/35/20°C | EFFEKT (W)<br>55/45/20°C | EFFEKT (W)<br>60/45/20°C | VOLYM<br>(l) | N-<br>EXPONENT | VIKT<br>(kg) |
|----------------|-------|------|-----------------------|-----------------------|--------------------------|--------------------------|--------------------------|--------------|----------------|--------------|
|                | 1200  | 70   | 6733672               |                       | 466                      | 819                      | 889                      | 7.9          | 1.32           | 31.9         |
|                | 1400  | 70   | 6733673               |                       | 543                      | 955                      | 1037                     | 9.2          | 1.32           | 37.3         |
|                | 1600  | 70   | 6733674               |                       | 621                      | 1092                     | 1185                     | 10.6         | 1.32           | 42.1         |
|                | 1800  | 70   | 6733675               |                       | 699                      | 1228                     | 1333                     | 11.9         | 1.32           | 47.2         |
|                | 2000  | 70   | 6733676               |                       | 776                      | 1365                     | 1481                     | 13.2         | 1.32           | 52.3         |
|                | 2300  | 70   | F062106023010300      | 6733677               | 893                      | 1569                     | 1703                     | 15.2         | 1.32           | 60.0         |
|                | 2600  | 70   | F062106026010300      | 6733678               | 1009                     | 1774                     | 1925                     | 17.2         | 1.32           | 67.6         |
|                | 3000  | 70   | 6733679               |                       | 1164                     | 2047                     | 2221                     | 19.8         | 1.32           | 77.8         |
| <b>Typ 22</b>  |       |      |                       |                       |                          |                          |                          |              |                |              |
|                | 400   | 102  | 6733162               |                       | 195                      | 346                      | 375                      | 2.6          | 1.34           | 13.8         |
|                | 500   | 102  | 6733163               |                       | 244                      | 432                      | 469                      | 3.3          | 1.34           | 16.8         |
|                | 600   | 102  | F062206006010300      | 6733164               | 293                      | 518                      | 563                      | 4.0          | 1.34           | 19.6         |
|                | 700   | 102  | 6733165               |                       | 342                      | 605                      | 657                      | 4.6          | 1.34           | 22.6         |
|                | 800   | 102  | 6733166               |                       | 391                      | 691                      | 750                      | 5.3          | 1.34           | 25.5         |
|                | 900   | 102  | 6733167               |                       | 440                      | 777                      | 844                      | 5.9          | 1.34           | 28.4         |
|                | 1000  | 102  | 6733168               |                       | 488                      | 864                      | 938                      | 6.6          | 1.34           | 31.4         |
|                | 1100  | 102  | 6733169               |                       | 537                      | 950                      | 1032                     | 7.3          | 1.34           | 34.3         |
|                | 1200  | 102  | 6733170               |                       | 586                      | 1037                     | 1126                     | 7.9          | 1.34           | 37.2         |
|                | 1400  | 102  | 6733171               |                       | 684                      | 1209                     | 1314                     | 9.2          | 1.34           | 43.9         |
|                | 1600  | 102  | 6733172               |                       | 781                      | 1382                     | 1501                     | 10.6         | 1.34           | 49.0         |
|                | 1800  | 102  | 6733173               |                       | 879                      | 1555                     | 1689                     | 11.9         | 1.34           | 54.9         |
|                | 2000  | 102  | 6733174               |                       | 977                      | 1728                     | 1876                     | 13.2         | 1.34           | 6.7          |
|                | 2300  | 102  | 6733175               |                       | 1123                     | 1987                     | 2158                     | 15.2         | 1.34           | 69.5         |
|                | 2600  | 102  | 6733176               |                       | 1270                     | 2246                     | 2439                     | 17.2         | 1.34           | 78.3         |
|                | 3000  | 102  | 6733177               |                       | 1465                     | 2591                     | 2815                     | 19.8         | 1.34           | 90.0         |

## Typ 33



# 600

| HÖJD<br>600 mm | LÄNGD | DJUP | Artikelnr/<br>RSK (V) | Artikelnr/<br>RSK (H) | EFFEKT (W)<br>45/35/20°C | EFFEKT (W)<br>55/45/20°C | EFFEKT (W)<br>60/45/20°C | VOLYM<br>(l) | N-<br>EXPONENT | VIKT<br>(kg) |
|----------------|-------|------|-----------------------|-----------------------|--------------------------|--------------------------|--------------------------|--------------|----------------|--------------|
|                | 400   | 152  |                       | 6733258               | 266                      | 473                      | 514                      | 3.9          | 1.35           | 2.8          |
|                | 500   | 152  | F063306005010300      | 6733259               | 333                      | 592                      | 643                      | 4.9          | 1.35           | 24.5         |
|                | 600   | 152  |                       | 6733260               | 399                      | 710                      | 772                      | 5.9          | 1.35           | 28.9         |
|                | 700   | 152  |                       | 6733261               | 466                      | 828                      | 900                      | 6.9          | 1.35           | 33.3         |
|                | 800   | 152  |                       | 6733262               | 532                      | 946                      | 1029                     | 7.8          | 1.35           | 37.6         |
|                | 900   | 152  |                       | 6733263               | 599                      | 1065                     | 1157                     | 8.8          | 1.35           | 42.2         |
|                | 1000  | 152  |                       | 6733264               | 665                      | 1183                     | 1286                     | 9.8          | 1.35           | 46.4         |
|                | 1100  | 152  |                       | 6733265               | 732                      | 1301                     | 1415                     | 10.8         | 1.35           | 5.9          |
|                | 1200  | 152  | F063306012010300      | 6733266               | 798                      | 1420                     | 1543                     | 11.8         | 1.35           | 55.2         |
|                | 1400  | 152  |                       | 6733267               | 931                      | 1656                     | 1800                     | 13.7         | 1.35           | 64.0         |
|                | 1600  | 152  |                       | 6733268               | 1064                     | 1893                     | 2058                     | 15.7         | 1.35           | 72.8         |
|                | 1800  | 152  |                       | 6733269               | 1197                     | 2129                     | 2315                     | 17.6         | 1.35           | 81.5         |
|                | 2000  | 152  |                       | 6733270               | 1330                     | 2366                     | 2572                     | 19.6         | 1.35           | 9.4          |
|                | 2300  | 152  |                       | 6733271               | 1530                     | 2721                     | 2958                     | 22.5         | 1.35           | 105.5        |
|                | 2600  | 152  |                       | 6733272               | 1730                     | 3076                     | 3344                     | 25.5         | 1.35           | 116.7        |
|                | 3000  | 152  |                       | 6733273               | 1996                     | 3549                     | 3858                     | 29.4         | 1.35           | 134.3        |



## 900

| HÖJD<br>900 mm | LÄNGD | DJUP             | Artikelnr/<br>RSK (V) | Artikelnr/<br>RSK (H) | EFFEKT (W)<br>45/35/20°C | EFFEKT (W)<br>55/45/20°C | EFFEKT (W)<br>60/45/20°C | VOLYM<br>(l) | N-<br>EXPONENT | VIKT<br>(kg) |
|----------------|-------|------------------|-----------------------|-----------------------|--------------------------|--------------------------|--------------------------|--------------|----------------|--------------|
| <b>Typ 11</b>  |       |                  |                       |                       |                          |                          |                          |              |                |              |
| 400            | 60    |                  | 6732986               |                       | 166                      | 291                      | 316                      | 1.8          | 1.32           | 11.9         |
| 500            | 60    |                  | 6732987               |                       | 208                      | 364                      | 395                      | 2.3          | 1.32           | 14.3         |
| 600            | 60    | F061109006010300 | 6732988               |                       | 249                      | 437                      | 474                      | 2.7          | 1.32           | 16.8         |
| 700            | 60    |                  | 6732989               |                       | 291                      | 510                      | 553                      | 3.1          | 1.32           | 19.2         |
| 800            | 60    |                  | 6732990               |                       | 332                      | 583                      | 632                      | 3.6          | 1.32           | 21.7         |
| 900            | 60    |                  | 6732991               |                       | 373                      | 655                      | 711                      | 4.0          | 1.32           | 24.2         |
| 1000           | 60    |                  | 6732992               |                       | 415                      | 728                      | 790                      | 4.5          | 1.32           | 26.7         |
| 1100           | 60    |                  | 6732993               |                       | 457                      | 801                      | 869                      | 5.0          | 1.32           | 29.2         |
| 1200           | 60    | F061109012010300 | 6732994               |                       | 498                      | 874                      | 948                      | 5.4          | 1.32           | 31.6         |
| 1400           | 60    |                  | 6732995               |                       | 581                      | 1019                     | 1106                     | 6.3          | 1.32           | 36.6         |
| 1600           | 60    |                  | 6732996               |                       | 664                      | 1165                     | 1264                     | 7.2          | 1.32           | 41.6         |
| 1800           | 60    |                  | 6732997               |                       | 747                      | 1311                     | 1422                     | 8.1          | 1.32           | 46.5         |
| 2000           | 60    |                  | 6732998               |                       | 830                      | 1456                     | 1580                     | 9.0          | 1.32           | 51.5         |
| 2300           | 60    |                  | 6732999               |                       | 955                      | 1675                     | 1817                     | 10.3         | 1.32           | 58.9         |
| 2600           | 60    |                  | 6733000               |                       | 1079                     | 1893                     | 2054                     | 11.7         | 1.32           | 66.4         |
| 3000           | 60    | F061109030010300 | 6733001               |                       | 1245                     | 2185                     | 2370                     | 13.5         | 1.32           | 76.3         |
| <b>Typ 21</b>  |       |                  |                       |                       |                          |                          |                          |              |                |              |
| 400            | 70    |                  | 6733680               |                       | 212                      | 376                      | 408                      | 3.6          | 1.34           | 16.7         |
| 500            | 70    | F062109005010300 | 6733681               |                       | 265                      | 470                      | 510                      | 4.5          | 1.34           | 2.6          |
| 600            | 70    |                  | 6733682               |                       | 318                      | 563                      | 612                      | 5.4          | 1.34           | 24.3         |
| 700            | 70    | F062109007010300 | 6733683               |                       | 371                      | 657                      | 714                      | 6.3          | 1.34           | 28.6         |
| 800            | 70    |                  | 6733684               |                       | 424                      | 751                      | 816                      | 7.2          | 1.34           | 31.8         |
| 900            | 70    |                  | 6733685               |                       | 477                      | 845                      | 918                      | 8.1          | 1.34           | 35.6         |
| 1000           | 70    |                  | 6733686               |                       | 530                      | 939                      | 1020                     | 9.0          | 1.34           | 39.5         |
| 1100           | 70    |                  | 6733687               |                       | 583                      | 1033                     | 1122                     | 9.9          | 1.34           | 43.2         |



## 900

| HÖJD<br>900 mm | LÄNGD | DJUP | Artikelnr/<br>RSK (V) | Artikelnr/<br>RSK (H) | EFFEKT (W)<br>45/35/20°C | EFFEKT (W)<br>55/45/20°C | EFFEKT (W)<br>60/45/20°C | VOLYM<br>(l) | N-<br>EXPONENT | VIKT<br>(kg) |
|----------------|-------|------|-----------------------|-----------------------|--------------------------|--------------------------|--------------------------|--------------|----------------|--------------|
|                | 1200  | 70   |                       | 6733688               | 636                      | 1127                     | 1224                     | 10.8         | 1.34           | 47.0         |
|                | 1400  | 70   | F062109014010300      | 6733689               | 742                      | 1315                     | 1428                     | 12.6         | 1.34           | 54.5         |
|                | 1600  | 70   | F062109016010300      | 6733690               | 849,848                  | 1502                     | 1632                     | 14.4         | 1.34           | 62.8         |
|                | 1800  | 70   |                       | 6733691               | 954                      | 1690                     | 1836                     | 16.2         | 1.34           | 69.6         |
|                | 2000  | 70   |                       | 6733692               | 1060                     | 1878                     | 2040                     | 18.0         | 1.34           | 77.2         |
|                | 2300  | 70   |                       | 6733693               | 1219                     | 2160                     | 2346                     | 20.7         | 1.34           | 88.5         |
|                | 2600  | 70   |                       | 6733694               | 1379                     | 2442                     | 2653                     | 23.4         | 1.34           | 101.8        |
|                | 3000  | 70   |                       | 6733695               | 1591                     | 2817                     | 3060                     | 27.0         | 1.34           | 115.0        |
| <b>Typ 22</b>  |       |      |                       |                       |                          |                          |                          |              |                |              |
|                | 400   | 102  |                       | 6733178               | 268                      | 478                      | 520                      | 3.6          | 1.36           | 19.8         |
|                | 500   | 102  |                       | 6733179               | 335                      | 597                      | 650                      | 4.5          | 1.36           | 24.2         |
|                | 600   | 102  |                       | 6733180               | 402                      | 717                      | 780                      | 5.4          | 1.36           | 28.7         |
|                | 700   | 102  |                       | 6733181               | 469                      | 836                      | 910                      | 6.3          | 1.36           | 33.2         |
|                | 800   | 102  |                       | 6733182               | 536                      | 956                      | 1039                     | 7.2          | 1.36           | 37.7         |
|                | 900   | 102  |                       | 6733183               | 603                      | 1075                     | 1169                     | 8.1          | 1.36           | 42.2         |
|                | 1000  | 102  |                       | 6733184               | 670                      | 1194                     | 1299                     | 9.0          | 1.36           | 46.7         |
|                | 1100  | 102  |                       | 6733185               | 737                      | 1314                     | 1429                     | 9.9          | 1.36           | 51.2         |
|                | 1200  | 102  |                       | 6733186               | 804                      | 1433                     | 1559                     | 10.8         | 1.36           | 55.7         |
|                | 1400  | 102  |                       | 6733187               | 937                      | 1672                     | 1819                     | 12.6         | 1.36           | 64.7         |
|                | 1600  | 102  |                       | 6733188               | 1071                     | 1911                     | 2079                     | 14.4         | 1.36           | 73.7         |
|                | 1800  | 102  |                       | 6733189               | 1205                     | 2150                     | 2338                     | 16.2         | 1.36           | 82.7         |
|                | 2000  | 102  |                       | 6733190               | 1339                     | 2389                     | 2598                     | 18.0         | 1.36           | 91.6         |
|                | 2300  | 102  | F062209023010300      | 6733191               | 1540                     | 2747                     | 2988,2987                | 20.7         | 1.36           | 107.2        |
|                | 2600  | 102  |                       | 6733192               | 1741                     | 3106                     | 3378                     | 23.4         | 1.36           | 118.7        |
|                | 3000  | 102  |                       | 6733193               | 2009                     | 3583                     | 3897                     | 27.0         | 1.36           | 136.6        |

## Typ 33



# 900

| HÖJD<br>900 mm | LÄNGD | DJUP | Artikelnr/<br>RSK (V) | Artikelnr/<br>RSK (H) | EFFEKT (W)<br>45/35/20°C | EFFEKT (W)<br>55/45/20°C | EFFEKT (W)<br>60/45/20°C | VOLYM<br>(l) | N-<br>EXPONENT | VIKT<br>(kg) |
|----------------|-------|------|-----------------------|-----------------------|--------------------------|--------------------------|--------------------------|--------------|----------------|--------------|
|                | 400   | 152  |                       | 6733274               | 364                      | 651                      | 708                      | 5.3          | 1.36           | 28.7         |
|                | 500   | 152  | F063309005010300      | 6733275               | 455                      | 814                      | 885                      | 6.7          | 1.36           | 35.4         |
|                | 600   | 152  |                       | 6733276               | 546                      | 976                      | 1062                     | 8.0          | 1.36           | 42.9         |
|                | 700   | 152  |                       | 6733277               | 637                      | 1139                     | 1239                     | 9.3          | 1.36           | 48.8         |
|                | 800   | 152  |                       | 6733278               | 729                      | 1302                     | 1416                     | 10.6         | 1.36           | 55.5         |
|                | 900   | 152  |                       | 6733279               | 820                      | 1465                     | 1593                     | 12.0         | 1.36           | 62.3         |
|                | 1000  | 152  |                       | 6733280               | 911                      | 1627                     | 1770                     | 13.3         | 1.36           | 68.9         |
|                | 1100  | 152  |                       | 6733281               | 1002                     | 1790                     | 1947                     | 14.6         | 1.36           | 75.6         |
|                | 1200  | 152  |                       | 6733282               | 1093                     | 1953                     | 2124                     | 16.0         | 1.36           | 82.3         |
|                | 1400  | 152  | F063309014010300      | 6733283               | 1275                     | 2278                     | 2478                     | 19.0         | 1.36           | 96.0         |
|                | 1600  | 152  |                       | 6733284               | 1457                     | 2604                     | 2832                     | 21.3         | 1.36           | 111.3        |
|                | 1800  | 152  |                       | 6733285               | 1639                     | 2929                     | 3187                     | 23.9         | 1.36           | 122.6        |
|                | 2000  | 152  |                       | 6733286               | 1821                     | 3255                     | 3541                     | 26.6         | 1.36           | 136.0        |
|                | 2300  | 152  |                       | 6733287               | 2095                     | 3743                     | 4072                     | 30.6         | 1.36           | 156.8        |
|                | 2600  | 152  |                       | 6733288               | 2368                     | 4231                     | 4603                     | 34.6         | 1.36           | 176.2        |
|                | 3000  | 152  |                       | 6733289               | 2732                     | 4882                     | 5311                     | 39.9         | 1.36           | 207.0        |