



Datablad

2026-07-01

Compact

Standardradiator med 4 x 1/2" anslutning, galler och sidoplåtar.

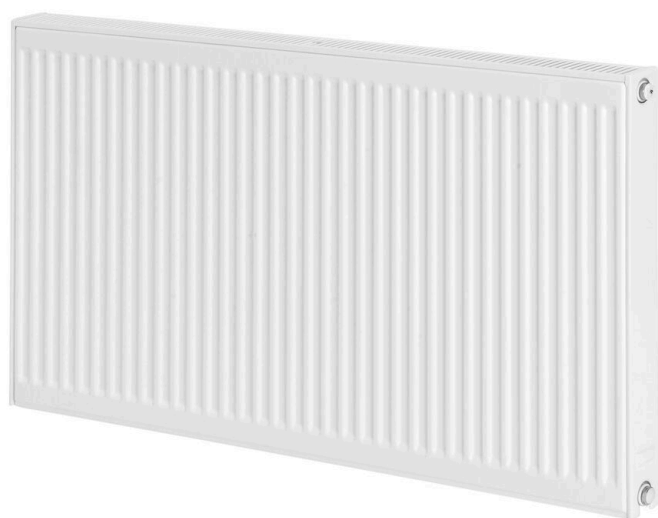

- ✓ Galler och sidoplåtar på alla modeller
- ✓ Kan monteras på golvkonsol
- ✓ Även för diagonal och ryttarkoppling
- ✓ Effektiv värmefördelning
- ✓ Brett utbud av färger

Compact är med sin stilrena design en klassisk panelradiator för slutna vattenburna värmesystem. Panelradiator Compact har fyra G 1/2" anslutningar med invändig gänga, vilket möjliggör sidoanslutning på både höger och vänster sida. En verklig kvalitetsradiator med mycket hög finish. Compact är konstruerad för optimal värmeavgivning enligt standarden EN442-1 och alla modeller är CE-märkta. Compact levereras med monterade sidoplåtar och toppgaller med barnsäker infästning. Konsoler, galler, sidoplåtar, blindpropp och luftskruv ingår. Driftsförhållandena bör alltid beaktas och monteringsanvisning bör följas vid installation. Standardfärg vit RAL 9016 (på begäran även andra kulörer mot en extra kostnad). Garantitiden är 10 år. Leveransinnehåll: Purmo Compact är försedd med monterade sidoplåtar och toppgaller samt omfattande konsoler, luftskruv och propp. Övrigt: Purmo Compact finns i typ 11, 21, 22 och 33.



Användningsområde

Lämplig för bostads- och kommersiella byggnader. Perfekt för flerbostadshus, fjärrvärmesystem och större installationer.

Dimensionering

Effekter för olika driftstemperaturer finns i tabell nedan. För andra temperaturer rekommenderas hemsida eller excel-fil. Produkten finns också i Magicloud för detaljerad beräkning.

Användning

Inkoppling sker genom 4 x G 1/2" sidouttag, tillopp i toppen och retur i botten. Kan också kopplas in diagonalt utan effektförlust. Seriekoppling av flera radiatorer rekommenderas ej på grund av risk för stort effekttapp på den seriekopplade radiatoren. Monteras i torra miljöer, ej lämplig där återkommande hög luftfuktighet förekommer.

AMA Text

PTB.1 Radiatorer

PTB.11 Panelradiatorer

Purmo Typ Compact:

Fabrikat Purmo typ Compact. Tryckklass PN10. Försedd med sidoplåtar och toppgaller. Kulör Vit RAL 9016.

Levereras med luftningsventil, bottenplugg och omfattande låsbara Monclac väggkonsoler. Levereras skyddsemballerad och med frontskydd som tas bort i samband med slutrengöring.

C XX-HLL (ex. PURMO C 11 300x400)

Effektgrupp-höjd, längd (mm)

Kompletterande text:

Förses med MMA-koppel

Tillbehör panelradiatorer:

Golvkonsoler

Låsbyglar för offentliga lokaler

Tilluftsdon Purmo Air

Handduksstång



Specifikationer

EGENSKAPER	ENHET	VÄRDEN
ETIM Class		EC011022
Material		Stål
Typ		11, 21, 22, 33
Ytstruktur		Profilerad
Max arbetstryck	bar	10
Antal standardanslutningar		4
Värmeangivning enligt erkänt EN 442-laboratorium		Ja
Max. driftstemperatur	°C	110
Standardfärg		Ja
Färg		Vit
RAL nummer		9016
Galler/Täckplåt		Ja
Galler/Täckplåt		Ja
Glansvärde		Blank
Gängdimension (tum)		1/2"
Anslutning gänga		Invändig gänga
Med enpunktsanslutning		Ja
Med luftningsanslutning		Ja
Med luftningsventil/avluftare		Ja
Med avtappningsmöjlighet		Ja



Dokument

DOKUMENT	DOKUMENTTYP	LÄNK
Datablad Kulörer - Panelradiatorer och Konvektorer	Brochure	https://asset.productmarketingcloud.com/api/assetstorage/3577_68e483fa-ca55-43d0-bcd9-2d8f352bad7b
Purmo Konceptbroschyr	Brochure	https://asset.productmarketingcloud.com/api/assetstorage/3577_bd3b1722-bd77-469b-8a77-09d0bdcd4214
Drift och skötsel Radiatorer och konvektorer	User	https://asset.productmarketingcloud.com/api/assetstorage/3577_bc72a430-42d1-4e59-ae7e-2ad7324d15cd
Användarmanual - Flamingo V2 (FLA)	Installation	https://asset.productmarketingcloud.com/api/assetstorage/3577_d7d4bd99-e485-4573-aeaf-a6fab22b9253



Resurser



ProductImage - Purmo Compact, C, detail above.



ProductImage - Purmo Compact, C, product image 30 degrees.

COMPACT (mm)				
	C11		C21s, C22, C33	
A	a1	a2	a1	a2
400-1600	117	-	133	-
1800	117	917	133	900
2000	117	1017	133	1000
2300	117	1150	133	1167
2600	117	1317	133	1300
3000	117	1517	133	1500

DimensionalDrawing - Compact, mått på byggeplacering

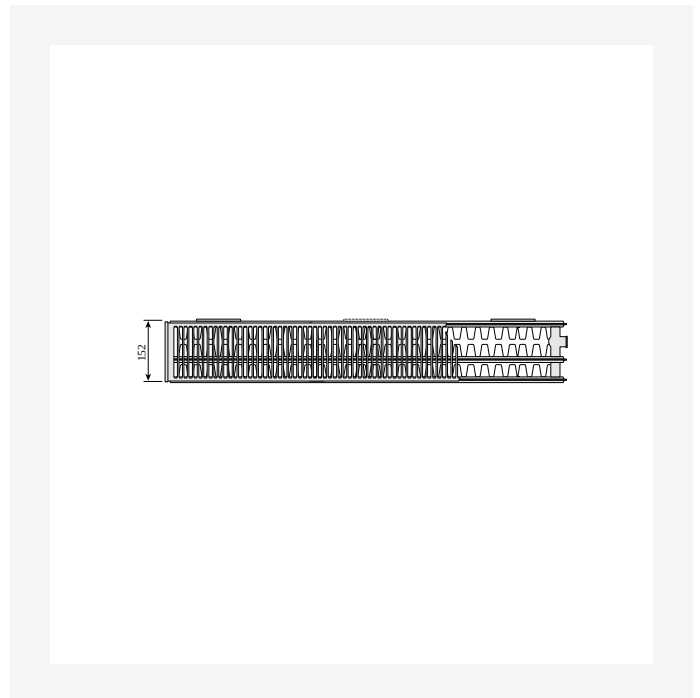

DimensionalDrawing - Compact, typ 33 toppvy



Resurser

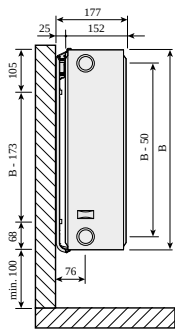

DimensionalDrawing - Compact, typ 33 sidovy

DimensionalDrawing - Compact, typ 22 toppvy

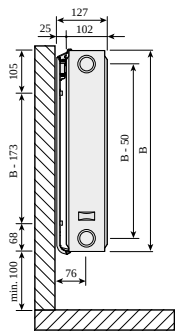

DimensionalDrawing - Compact, typ 22 sidovy

DimensionalDrawing - Compact, typ 21 toppvy



Resurser

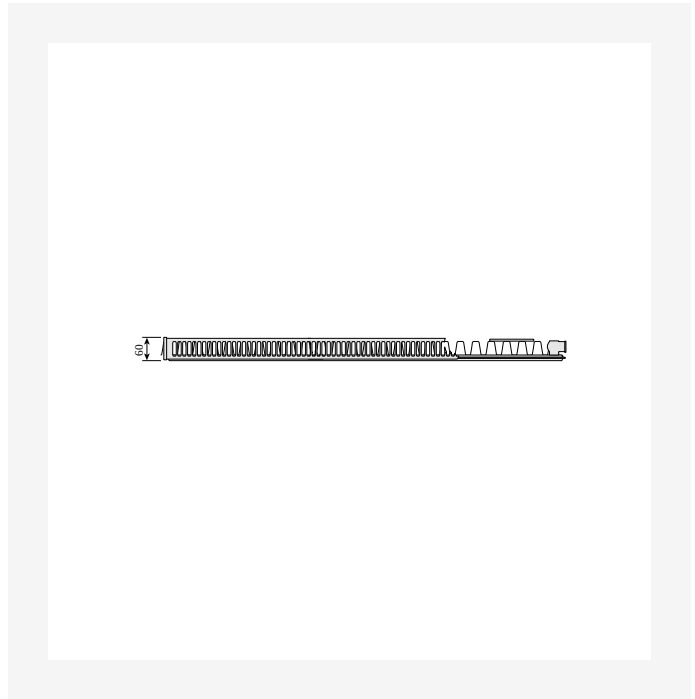
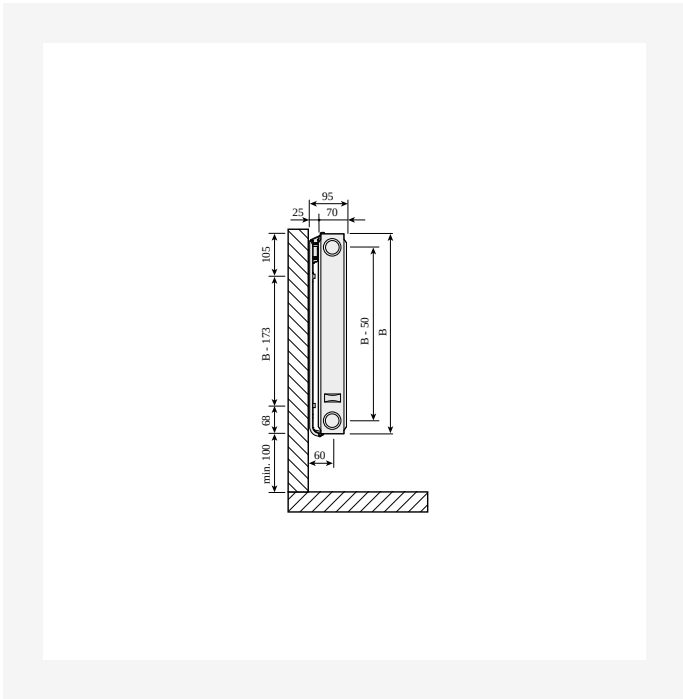

DimensionalDrawing - Compact, typ 21 sidovy

DimensionalDrawing - Compact, typ 11 toppvy

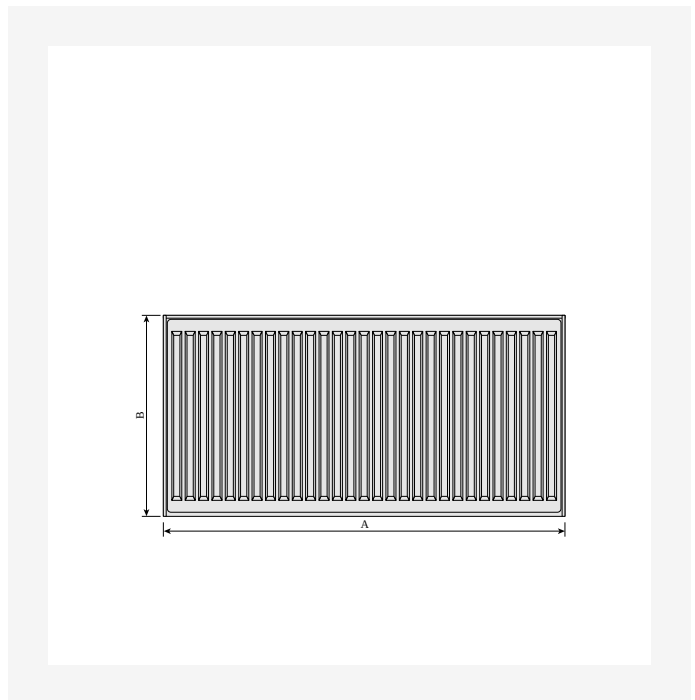
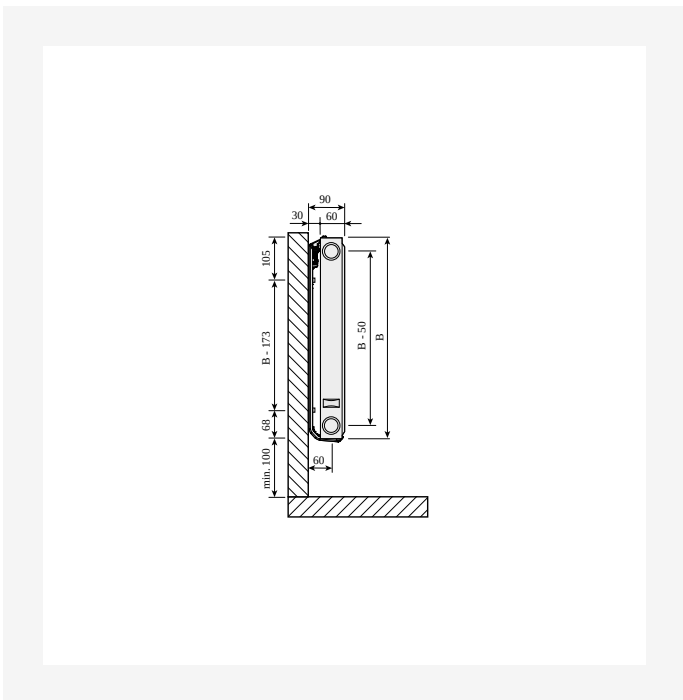

DimensionalDrawing - Compact, typ 11 sidovy

DimensionalDrawing - Compact, frontvy



Resurser

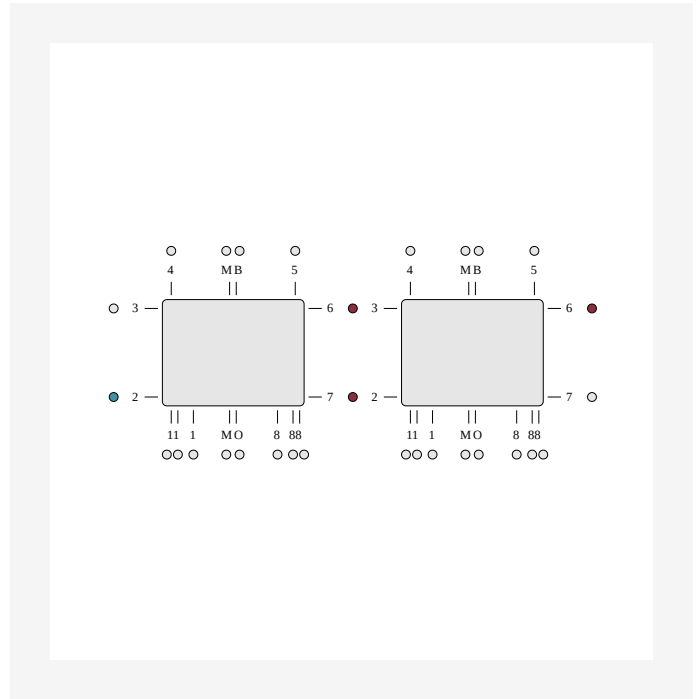
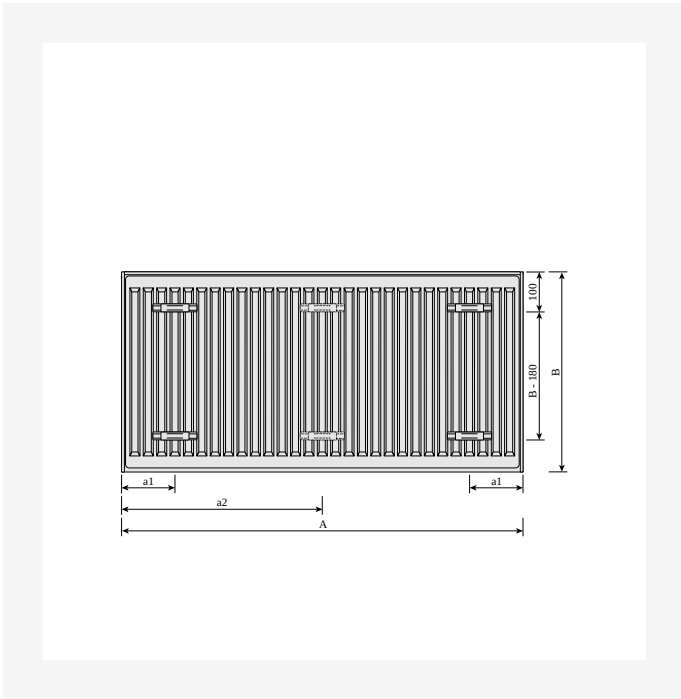

DimensionalDrawing - Compact, baksidesvy

DimensionalDrawing - Seriekoppling höger ETIM 62

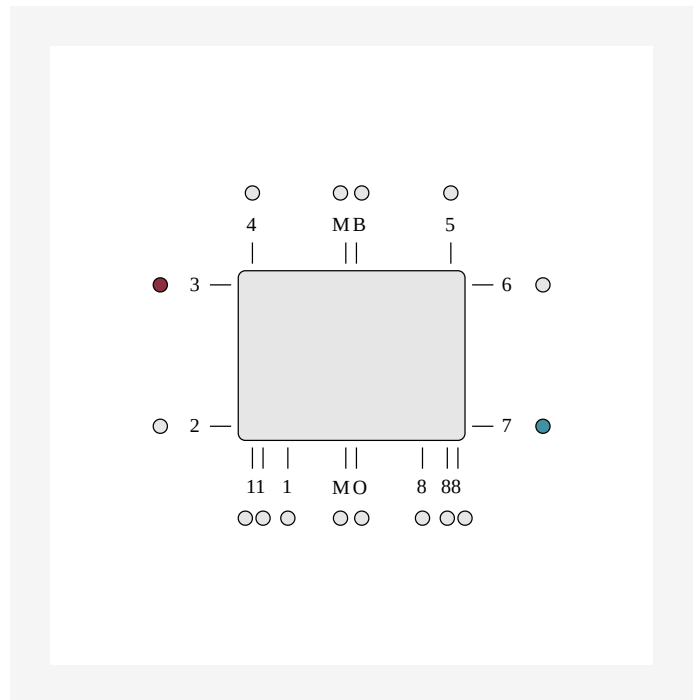
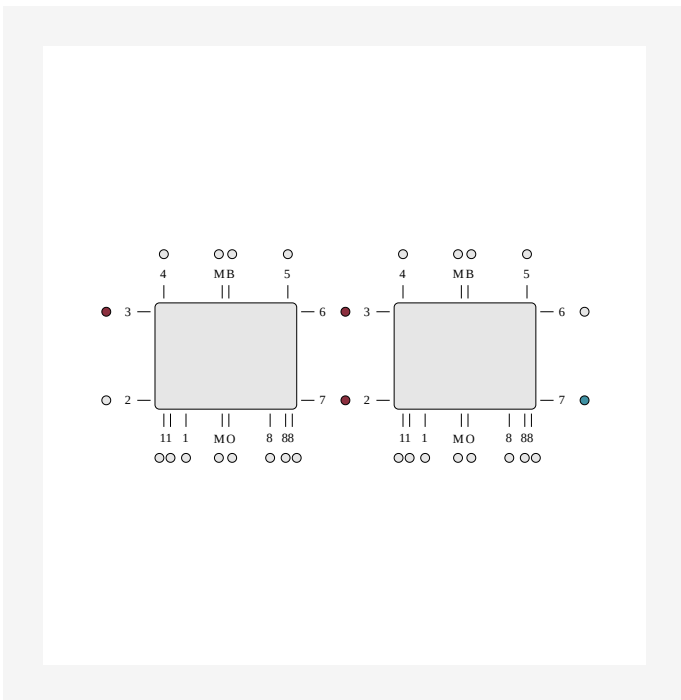

DimensionalDrawing - Diagonal seriekoppling vänster ETIM 37

DimensionalDrawing - Diagonal anslutning ETIM 37



Resurser

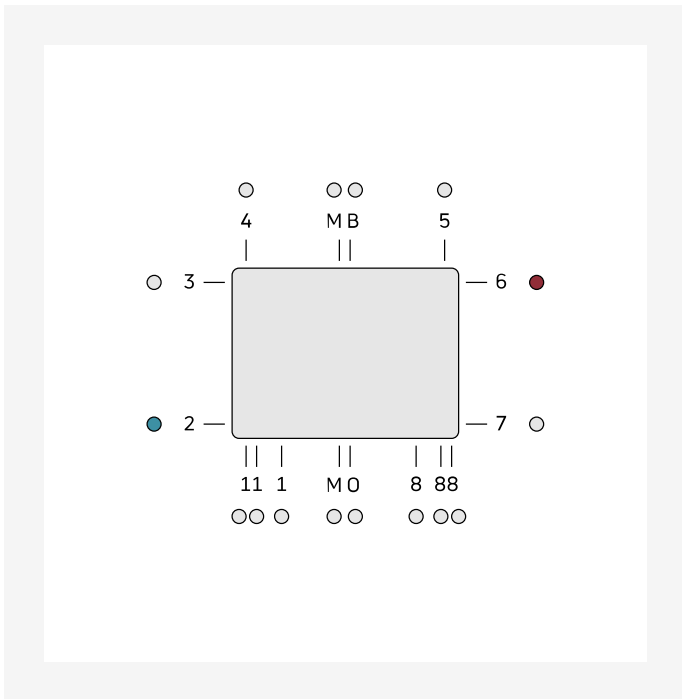

DimensionalDrawing - Diagonal anslutning ETIM 62.



Relaterade produkter



Sensor



Toppgaller Purmo/TP



Air



Luftskruv och blindplugg set



Bättringsfärg



Sidopanel Purmo



Luftskruv



Väggkonsol Monclac typ 11,21,22 & 33



Luftnyckel



Flex Radiatorkoppel



Radiatorkoppel Evoflow



Låsbygel



Relaterade produkter

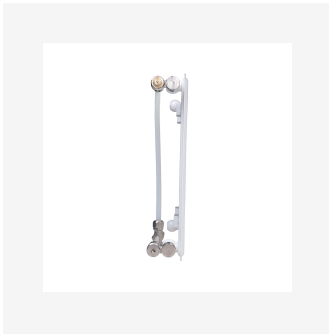

Radiatorkoppel FLK



Termostat Evosense



Returventil RV

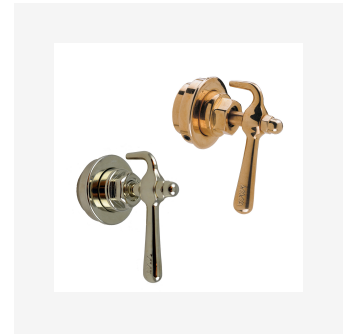

Slottsvred SNH



Evosense Sprint Termostat



Inklädnad av konsollben



Evoflow Radiator ventil



Slottsventil FV



Termostat Evosense Public



Returventil RRV

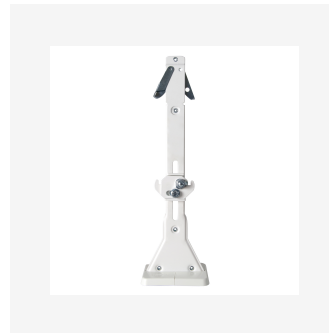

Golvkonsol Purmo Monclac



Slottsventil returventil



Relaterade produkter

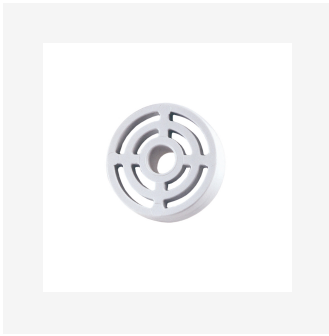

Väggdistans



Evosense Remote Termostat

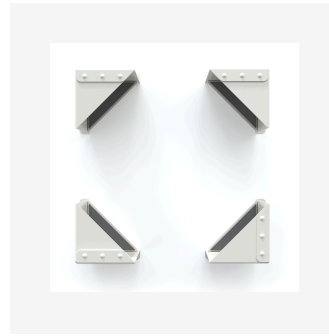

Fängelsekonsol



300

HÖJD 300 mm	LÄNGD	DJUP	Artikelnr/ RSK (V)	Artikelnr/ RSK (H)	EFFEKT (W) 45/35/20°C	EFFEKT (W) 55/45/20°C	EFFEKT (W) 60/45/20°C	VOLYM (l)	N- EXPONENT	VIKT (kg)
Typ 11										
400	60		F061103004010300	6732906	65	113	122	0.7	1.30	4.4
500	60			6732907	81	141	152	0.8	1.30	5.1
600	60		F061103006010300	6732908	97	169	183	1.0	1.30	5.9
700	60			6732909	113	197	213	1.2	1.30	6.7
800	60			6732910	129	225	244	1.4	1.30	7.5
900	60			6732911	145	253	274	1.5	1.30	8.3
1000	60			6732912	162	281	305	1.7	1.30	9.2
1100	60			6732913	178	309	336	1.9	1.30	10.0
1200	60			6732914	194	338	366	2.0	1.30	1.6
1400	60		F061103014010300	6732915	226	394	427	2.4	1.30	12.2
1600	60		F061103016010300	6732916	259	450	488	2.7	1.30	13.8
1800	60			6732917	291	506	549	3.1	1.30	15.4
2000	60			6732918	323	563	610	3.4	1.30	17.0
2300	60			6732919	372	647	701	3.9	1.30	19.4
2600	60			6732920	420	731	793	4.4	1.30	21.7
3000	60			6732921	485	844	915	5.1	1.30	24.9
Typ 21										
400	70			6733600	92	158	171	1.4	1.28	6.2
500	70			6733601	115	198	214	1.7	1.28	7.4
600	70			6733602	138	237	257	2.0	1.28	8.6
700	70		F062103007010300	6733603	160	277	300	2.4	1.28	10.0
800	70		F062103008010300	6733604	183	317	343	2.7	1.28	11.3
900	70			6733605	206	356	386	3.1	1.28	12.3
1000	70			6733606	229	396	428	3.4	1.28	13.6



300

HÖJD 300 mm	LÄNGD	DJUP	Artikelnr/ RSK (V)	Artikelnr/ RSK (H)	EFFEKT (W) 45/35/20°C	EFFEKT (W) 55/45/20°C	EFFEKT (W) 60/45/20°C	VOLYM (l)	N- EXPONENT	VIKT (kg)
	1100	70	6733607		252	435	471	3.7	1.28	14.8
	1200	70	6733608		275	475	514	4.1	1.28	16.4
	1400	70	6733609		321	554	599	4.8	1.28	18.7
	1600	70	6733610		367	633	686	5.4	1.28	21.1
	1800	70	F062103018010300	6733611	412	712	771	6.1	1.28	23.6
	2000	70	6733612		458	791	857	6.8	1.28	26.1
	2300	70	6733613		527	910	985	7.8	1.28	30.0
	2600	70	6733614		596	1029	1114	8.8	1.28	33.7
	3000	70	6733615		687	1187	1285	10.2	1.28	38.7
Typ 22										
	400	102	6733098		112	197	213	1.4	1.31	7.2
	500	102	6733099		141	246	267	1.7	1.31	8.5
	600	102	6733100		169	295	321	2.0	1.31	10.1
	700	102	6733101		197	345	374	2.4	1.31	11.4
	800	102	6733102		225	394	427	2.7	1.31	12.8
	900	102	6733103		253	443	481	3.1	1.31	14.2
	1000	102	6733104		282	492	534	3.4	1.31	15.6
	1100	102	6733105		310	542	587	3.7	1.31	17.4
	1200	102	6733106		338	591	641	4.1	1.31	18.5
	1400	102	6733107		394	689	747	4.8	1.31	21.3
	1600	102	6733108		451	788	854	5.4	1.31	24.2
	1800	102	6733109		507	886	961	6.1	1.31	27.1
	2000	102	6733110		563	985	1068	6.8	1.31	29.9
	2300	102	6733111		647	1132	1228	7.8	1.31	34.1
	2600	102	F062203026010300	6733112	732	1280	1388	8.8	1.31	38.5
	3000	102	6733113		845	1477	1602	10.2	1.31	44.9



300

HÖJD 300 mm	LÄNGD	DJUP	Artikelnr/ RSK (V)	Artikelnr/ RSK (H)	EFFEKT (W) 45/35/20°C	EFFEKT (W) 55/45/20°C	EFFEKT (W) 60/45/20°C	VOLYM (l)	N- EXPONENT	VIKT (kg)
Typ 33										
400	152		6733194		157	275	299	2.0	1.31	1.3
500	152		6733195		197	344	374	2.5	1.31	12.4
600	152		6733196		236	413	448	3.1	1.31	14.5
700	152		6733197		275	482	523	3.6	1.31	16.7
800	152		6733198		314	551	598	4.1	1.31	18.8
900	152		6733199		353	620	672	4.6	1.31	2.9
1000	152		6733200		393	688	747	5.1	1.31	23.5
1100	152		6733201		432	757	822	5.6	1.31	25.2
1200	152		6733202		471	826	896	6.1	1.31	27.3
1400	152		6733203		550	964	1046	7.1	1.31	31.6
1600	152		6733204		629	1101	1195	8.2	1.31	35.8
1800	152		6733205		707	1239	1344	9.2	1.31	4.7
2000	152		6733206		786	1377	1493	10.2	1.31	44.3
2300	152		6733207		904	1583	1717	11.7	1.31	5.7
2600	152	F063303026010300	6733208	1022,1021	1790	1941	1941	13.3	1.31	57.9
3000	152		6733209		1179	2065	2240	15.3	1.31	65.6



400

HÖJD 400 mm	LÄNGD	DJUP	Artikelnr/ RSK (V)	Artikelnr/ RSK (H)	EFFEKT (W) 45/35/20°C	EFFEKT (W) 55/45/20°C	EFFEKT (W) 60/45/20°C	VOLYM (l)	N- EXPONENT	VIKT (kg)
Typ 11										
400	60		6732922		84	146	158	0.9	1.30	5.5
500	60		6732923		105	183	198	1.1	1.30	6.5
600	60		6732924		126	219	238	1.3	1.30	7.6
700	60		6732925		147	256	277	1.5	1.30	8.7
800	60		6732926		168	292	317	1.8	1.30	9.7
900	60		6732927		189	329	357	2.0	1.30	18
1000	60		6732928		210	366	396	2.2	1.30	11.8
1100	60		6732929		231	402	436	2.4	1.30	12.9
1200	60		6732930		251	439	475	2.6	1.30	14.0
1400	60	F061104014010300	6732931		294,293	512	555,554	3.1	1.30	16.1
1600	60		6732932		335	585	634	3.5	1.30	18.2
1800	60		6732933		377	658	713	4.0	1.30	2.4
2000	60		6732934		419	731	792	4.4	1.30	22.5
2300	60		6732935		482	841	911	5.1	1.30	25.7
2600	60		6732936		545	950	1030	5.7	1.30	28.9
3000	60		6732937		629	1097	1189	6.6	1.30	33.2
Typ 21										
400	70		6733616		114	199	215	1.8	1.29	7.7
500	70		6733617		143	249	270	2.3	1.29	9.4
600	70		6733618		172	298	323	2.7	1.29	11.1
700	70		6733619		200	348	377	3.1	1.29	12.8
800	70		6733620		229	398	431	3.6	1.29	14.5
900	70		6733621		258	448	485	4.0	1.29	16.2
1000	70		6733622		286	497	539	4.5	1.29	17.9
1100	70		6733623		315	547	592	5.0	1.29	19.6



400

HÖJD 400 mm	LÄNGD	DJUP	Artikelnr/ RSK (V)	Artikelnr/ RSK (H)	EFFEKT (W) 45/35/20°C	EFFEKT (W) 55/45/20°C	EFFEKT (W) 60/45/20°C	VOLYM (l)	N- EXPONENT	VIKT (kg)
	1200	70	F062104012010300	6733624	344	597	647,646	5.4	1.29	21.3
	1400	70		6733625	401	696	754	6.3	1.29	24.6
	1600	70		6733626	458	796	862	7.2	1.29	28.3
	1800	70		6733627	515	895	969	8.1	1.29	31.4
	2000	70	F062104020010300	6733628	573,572	994	1077	9.0	1.29	34.8
	2300	70	F062104023010300	6733629	658	1144	1239	10.3	1.29	39.9
	2600	70	F062104026010300	6733630	744	1293	1401,1400	11.7	1.29	44.9
	3000	70		6733631	859	1492	1616	13.5	1.29	51.7
Typ 22										
	400	102		6733114	142	249	270	1.8	1.32	9.2
	500	102		6733115	178	311	338	2.3	1.32	11.3
	600	102		6733116	213	374	406	2.7	1.32	13.3
	700	102		6733117	248	436	473	3.1	1.32	15.0
	800	102		6733118	284	498	541	3.6	1.32	16.9
	900	102		6733119	319	560	608	4.0	1.32	18.8
	1000	102		6733120	355	623	676	4.5	1.32	2.7
	1100	102		6733121	390	685	743	5.0	1.32	22.6
	1200	102		6733122	426	747	811	5.4	1.32	24.6
	1400	102	F062204014010300	6733123	497,496	872	946	6.3	1.32	28.4
	1600	102		6733124	568	996	1081	7.2	1.32	32.3
	1800	102		6733125	639	1121	1216	8.1	1.32	36.1
	2000	102		6733126	709	1245	1351	9.0	1.32	40.0
	2300	102		6733127	816	1432	1554	10.3	1.32	45.7
	2600	102		6733128	922	1619	1757	11.7	1.32	51.6
	3000	102		6733129	1064	1868	2027	13.5	1.32	59.2

Typ 33



400

HÖJD 400 mm	LÄNGD	DJUP	Artikelnr/ RSK (V)	Artikelnr/ RSK (H)	EFFEKT (W) 45/35/20°C	EFFEKT (W) 55/45/20°C	EFFEKT (W) 60/45/20°C	VOLYM (l)	N- EXPONENT	VIKT (kg)
400	152		6733210		196	345	375	2.7	1.33	13.5
500	152		6733211		245	432	469	3.4	1.33	16.4
600	152		6733212		294	518	562	4.0	1.33	19.2
700	152		6733213		343	604	656	4.7	1.33	22.1
800	152		6733214		392	691	750	5.4	1.33	25.0
900	152		6733215		441	777	843	6.0	1.33	27.9
1000	152	F063304010010300	6733216		490	863	937	6.7	1.33	3.8
1100	152		6733217		539	950	1031	7.4	1.33	33.6
1200	152		6733218		588	1036	1125	8.0	1.33	36.5
1400	152	F063304014010300	6733219		686	1209	1312	9.4	1.33	42.3
1600	152		6733220		784	1381	1499	10.7	1.33	48.5
1800	152		6733221		882	1554	1687	12.1	1.33	53.9
2000	152		6733222		980	1726	1874	13.4	1.33	59.6
2300	152		6733223		1128	1985	2155	15.4	1.33	68.2
2600	152		6733224		1274	2244	2436	17.4	1.33	76.9
3000	152		6733225		1471	2590	2811	20.1	1.33	88.4



450

HÖJD 450 mm	LÄNGD	DJUP	Artikelnr/ RSK (V)	Artikelnr/ RSK (H)	EFFEKT (W) 45/35/20°C	EFFEKT (W) 55/45/20°C	EFFEKT (W) 60/45/20°C	VOLYM (l)	N- EXPONENT	VIKT (kg)
Typ 11										
400	60		F061104504010300	6732938	93	162	176	1.0	1.30	6.4
500	60			6732939	116	203	220	1.3	1.30	7.6
600	60			6732940	139	243	264	1.5	1.30	8.9
700	60		F061104507010300	6732941	163	284	308	1.8	1.30	1.2
800	60			6732942	186	325	352	2.0	1.30	11.4
900	60			6732943	209	365	396	2.3	1.30	12.7
1000	60			6732944	232	406	440	2.5	1.30	14.0
1100	60			6732945	256	446	484	2.8	1.30	15.2
1200	60		F061104512010300	6732946	279	487	528	3.0	1.30	16.5
1400	60		F061104514010300	6732947	325	568	616	3.5	1.30	19.4
1600	60			6732948	372	649	704	4.0	1.30	21.5
1800	60		F061104518010300	6732949	418	730	792,791	4.5	1.30	24.5
2000	60			6732950	465	811	880	5.0	1.30	26.6
2300	60			6732951	535	933	1011	5.8	1.30	3.4
2600	60			6732952	604	1055	1143	6.5	1.30	34.2
3000	60			6732953	697	1217	1319	7.5	1.30	39.2
Typ 21										
400	70			6733632	125	218	236	2.0	1.30	9.3
500	70			6733633	157	273	296	2.5	1.30	11.3
600	70			6733634	188	327	355	3.0	1.30	13.4
700	70		F062104507010300	6733635	219	382	414	3.5	1.30	15.4
800	70			6733636	250	436	473	4.0	1.30	17.4
900	70		F062104509010300	6733637	282	491	532	4.5	1.30	19.4
1000	70			6733638	313	545	591	5.0	1.30	21.4
1100	70			6733639	344	600	650	5.5	1.30	23.5



450

HÖJD 450 mm	LÄNGD	DJUP	Artikelnr/ RSK (V)	Artikelnr/ RSK (H)	EFFEKT (W) 45/35/20°C	EFFEKT (W) 55/45/20°C	EFFEKT (W) 60/45/20°C	VOLYM (l)	N- EXPONENT	VIKT (kg)
	1200	70	6733640		376	654	709	6.0	1.30	25.5
	1400	70	6733641		438	764	828	7.0	1.30	29.5
	1600	70	6733642		501	873	946	8.0	1.30	33.6
	1800	70	F062104518010300	6733643	564,563	982	1064	9.0	1.30	37.7
	2000	70	6733644		626	1091	1182	10.0	1.30	41.6
	2300	70	6733645		720	1254	1360	11.5	1.30	47.7
	2600	70	6733646		814	1418	1537	13.0	1.30	53.8
	3000	70	6733647		939	1636	1773	15.0	1.30	61.9
Typ 22										
	400	102	6733130		156	274	298	2.0	1.32	1.6
	500	102	6733131		195	343	372	2.5	1.32	13.0
	600	102	6733132		234	411	446	3.0	1.32	15.3
	700	102	6733133		273	480	521	3.5	1.32	17.6
	800	102	6733134		312	548	595	4.0	1.32	19.9
	900	102	6733135		351	617	669	4.5	1.32	22.2
	1000	102	6733136		390	685	744	5.0	1.32	24.5
	1100	102	6733137		429	754	818	5.5	1.32	26.8
	1200	102	6733138		468	822	892	6.0	1.32	29.1
	1400	102	6733139		546	960	1042	7.0	1.32	33.7
	1600	102	6733140		623	1097	1190	8.0	1.32	38.3
	1800	102	6733141		702	1234	1339	9.0	1.32	43.0
	2000	102	6733142		779	1371	1488	10.0	1.32	47.6
	2300	102	6733143		896	1576	1711	11.5	1.32	54.5
	2600	102	6733144		1013	1782	1934	13.0	1.32	61.4
	3000	102	6733145		1169	2056	2232	15.0	1.32	7.6

Typ 33



450

HÖJD 450 mm	LÄNGD	DJUP	Artikelnr/ RSK (V)	Artikelnr/ RSK (H)	EFFEKT (W) 45/35/20°C	EFFEKT (W) 55/45/20°C	EFFEKT (W) 60/45/20°C	VOLYM (l)	N- EXPONENT	VIKT (kg)
	400	152	6733226		215	379	411	3.0	1.33	15.8
	500	152	6733227		268	473	514	3.8	1.33	19.2
	600	152	6733228		322	568	617	4.5	1.33	22.7
	700	152	F063304507010300	6733229	376,375	663	720,719	5.3	1.33	26.1
	800	152	F063304508010300	6733230	429	757	822	6.0	1.33	29.6
	900	152	6733231		483	852	925	6.8	1.33	33.7
	1000	152	6733232		536	947	1028	7.5	1.33	36.5
	1100	152	6733233		590	1041	1131	8.3	1.33	39.9
	1200	152	6733234		644	1136	1234	9.0	1.33	43.3
	1400	152	F063304514010300	6733235	751	1326	1440,1439	10.5	1.33	5.2
	1600	152	F063304516010300	6733236	858	1515	1645	12.0	1.33	57.1
	1800	152	6733237		965	1704	1850	13.5	1.33	64.1
	2000	152	6733238		1073	1894	2056	15.0	1.33	79
	2300	152	F063304523010300	6733239	1234	2178	2365,2364	17.3	1.33	81.2
	2600	152	6733240		1394	2462	2673	19.5	1.33	91.6
	3000	152	6733241		1609	2840	3084	22.5	1.33	107.4



500

HÖJD 500 mm	LÄNGD	DJUP	Artikelnr/ RSK (V)	Artikelnr/ RSK (H)	EFFEKT (W) 45/35/20°C	EFFEKT (W) 55/45/20°C	EFFEKT (W) 60/45/20°C	VOLYM (l)	N- EXPONENT	VIKT (kg)
Typ 11										
	400	60	6732954		102	178	193	1.1	1.31	6.5
	500	60	6732955		127	223	241	1.4	1.31	7.8
	600	60	6732956		153	267	290	1.6	1.31	9.2
	700	60	6732957		178	312	338	1.9	1.31	1.6
	800	60	6732958		204	356	386	2.2	1.31	12.0
	900	60	6732959		229	401	434	2.4	1.31	13.3
	1000	60	6732960		255	445	483	2.7	1.31	14.8
	1100	60	6732961		280	490	531	3.0	1.31	16.4
	1200	60	F061105012010300	6732962	306	534	579	3.2	1.31	17.5
	1400	60	6732963		357	623	676	3.8	1.31	2.2
	1600	60	6732964		408	712	772	4.3	1.31	22.9
	1800	60	6732965		459	801	869	4.9	1.31	25.7
	2000	60	6732966		510	890	965	5.4	1.31	28.4
	2300	60	6732967		586	1024	1110	6.2	1.31	32.6
	2600	60	6732968		663	1158	1255	7.0	1.31	36.7
	3000	60	6732969		764	1336	1448	8.1	1.31	43.0
Typ 21										
	400	70	F062105004010300	6733648	136	237	257	2.2	1.31	9.6
	500	70	6733649		170	296	321	2.8	1.31	11.7
	600	70	6733650		204	356	386	3.3	1.31	13.8
	700	70	F062105007010300	6733651	237	415	450	3.9	1.31	15.9
	800	70	6733652		271	474	514	4.4	1.31	18.1
	900	70	6733653		305	533	578	5.0	1.31	2.1
	1000	70	6733654		339	593	643	5.5	1.31	22.2
	1100	70	6733655		373	652	707	6.0	1.31	24.3



500

HÖJD 500 mm	LÄNGD	DJUP	Artikelnr/ RSK (V)	Artikelnr/ RSK (H)	EFFEKT (W) 45/35/20°C	EFFEKT (W) 55/45/20°C	EFFEKT (W) 60/45/20°C	VOLYM (l)	N- EXPONENT	VIKT (kg)
	1200	70		6733656	407	711	771	6.6	1.31	26.4
	1400	70		6733657	475	830	900	7.7	1.31	3.5
	1600	70		6733658	543	948	1029	8.8	1.31	34.7
	1800	70		6733659	611	1067	1157	9.9	1.31	38.9
	2000	70		6733660	678	1185	1285	11.0	1.31	43.9
	2300	70		6733661	780	1363	1478	12.7	1.31	49.4
	2600	70		6733662	882	1541	1671	14.3	1.31	55.6
	3000	70		6733663	1018	1778	1928	16.5	1.31	64.0
Typ 22										
	400	102	F062205004010300	6733146	169	299	324	2.2	1.33	11.2
	500	102		6733147	212	373	405	2.8	1.33	13.7
	600	102		6733148	254	448	486	3.3	1.33	16.4
	700	102		6733149	296	522	567	3.9	1.33	18.6
	800	102	F062205008010300	6733150	339	597	648	4.4	1.33	2.9
	900	102		6733151	381	672	729	5.0	1.33	23.4
	1000	102		6733152	424	746	810	5.5	1.33	25.8
	1100	102		6733153	466	821	891	6.0	1.33	28.3
	1200	102		6733154	508	896	972	6.6	1.33	3.6
	1400	102		6733155	593	1045	1134	7.7	1.33	35.5
	1600	102		6733156	678	1194	1296	8.8	1.33	4.3
	1800	102		6733157	762	1343	1458	9.9	1.33	45.2
	2000	102		6733158	847	1493	1620	11.0	1.33	5.1
	2300	102		6733159	974	1717	1863	12.7	1.33	57.3
	2600	102		6733160	1101	1940	2106	14.3	1.33	64.6
	3000	102		6733161	1271	2239	2431	16.5	1.33	74.3

Typ 33



500

HÖJD 500 mm	LÄNGD	DJUP	Artikelnr/ RSK (V)	Artikelnr/ RSK (H)	EFFEKT (W) 45/35/20°C	EFFEKT (W) 55/45/20°C	EFFEKT (W) 60/45/20°C	VOLYM (l)	N- EXPONENT	VIKT (kg)
	400	152		6733242	232	411	447	3.3	1.34	16.6
	500	152		6733243	291	514	559	4.1	1.34	2.2
	600	152	F063305006010300	6733244	349,348	617	670	4.9	1.34	23.9
	700	152		6733245	407	719	782	5.7	1.34	27.6
	800	152		6733246	465	822	893	6.6	1.34	31.1
	900	152		6733247	523	925	1005	7.4	1.34	34.8
	1000	152		6733248	581	1028	1116	8.2	1.34	38.5
	1100	152	F063305011010300	6733249	639	1131	1228	9.0	1.34	42.4
	1200	152		6733250	697	1233	1340	9.8	1.34	45.7
	1400	152		6733251	813	1439	1563	11.5	1.34	52.9
	1600	152		6733252	929	1645	1786	13.1	1.34	6.2
	1800	152		6733253	1045	1850	2010	14.8	1.34	67.5
	2000	152		6733254	1162	2056	2233	16.4	1.34	74.7
	2300	152		6733255	1336	2364	2568	18.9	1.34	85.6
	2600	152		6733256	1510	2672	2903	21.3	1.34	96.6
	3000	152		6733257	1742	3084	3349	24.6	1.34	111.9



550

HÖJD 550 mm	LÄNGD	DJUP	Artikelnr/ RSK	EFFEKT (W) 45/35/20°C	EFFEKT (W) 55/45/20°C	EFFEKT (W) 60/45/20°C	VOLYM (l)	N- EXPONENT	VIKT (kg)
Typ 22									
	800	102	F062205508010300	365	645	700	4.9	1.33	23.2
	1100	102	F062205511010300	502	887	962	6.7	1.33	31.5
	2300	102	F062205523010300	1050	1854	2012	14.0	1.33	64.6
	3000	102	F062205530010300	1370	2418	2625	18.3	1.33	83.9
Typ 33									
	3000	152	F063305530010300	1872	3319	3606	27.0	1.34	123.6



600

HÖJD 600 mm	LÄNGD	DJUP	Artikelnr/ RSK (V)	Artikelnr/ RSK (H)	EFFEKT (W) 45/35/20°C	EFFEKT (W) 55/45/20°C	EFFEKT (W) 60/45/20°C	VOLYM (l)	N- EXPONENT	VIKT (kg)
Typ 11										
400	60		F061106004010300	6732970	119	208	226	1.3	1.31	7.9
500	60		F061106005010300	6732971	149	260	282	1.6	1.31	9.5
600	60		F061106006010300	6732972	179	313	339	1.9	1.31	11.1
700	60			6732973	208	365	396	2.2	1.31	12.7
800	60			6732974	238	417	452	2.6	1.31	14.4
900	60			6732975	268	469	508	2.9	1.31	16.0
1000	60			6732976	298	521	565	3.2	1.31	17.6
1100	60			6732977	327	573	622	3.5	1.31	19.2
1200	60			6732978	357	625	678	3.8	1.31	2.9
1400	60			6732979	417	729	791	4.5	1.31	24.4
1600	60			6732980	476	834	904	5.1	1.31	27.3
1800	60			6732981	536	938	1017	5.8	1.31	3.5
2000	60		F061106020010300	6732982	595	1042	1130	6.4	1.31	33.7
2300	60			6732983	684	1198	1299	7.4	1.31	38.6
2600	60			6732984	774	1354	1469	8.3	1.31	43.4
3000	60			6732985	893	1563	1695	9.6	1.31	49.8
Typ 21										
400	70			6733664	155	273	296	2.6	1.32	11.5
500	70			6733665	194	341	370	3.3	1.32	14.4
600	70			6733666	233	409	444	4.0	1.32	16.6
700	70			6733667	272	478	518	4.6	1.32	19.2
800	70			6733668	311	546	592	5.3	1.32	21.7
900	70			6733669	349	614	666	5.9	1.32	24.3
1000	70			6733670	388	682	740	6.6	1.32	26.8
1100	70			6733671	427	751	814	7.3	1.32	29.4



600

HÖJD 600 mm	LÄNGD	DJUP	Artikelnr/ RSK (V)	Artikelnr/ RSK (H)	EFFEKT (W) 45/35/20°C	EFFEKT (W) 55/45/20°C	EFFEKT (W) 60/45/20°C	VOLYM (l)	N- EXPONENT	VIKT (kg)
	1200	70	6733672		466	819	889	7.9	1.32	31.9
	1400	70	6733673		543	955	1037	9.2	1.32	37.3
	1600	70	6733674		621	1092	1185	10.6	1.32	42.1
	1800	70	6733675		699	1228	1333	11.9	1.32	47.2
	2000	70	6733676		776	1365	1481	13.2	1.32	52.3
	2300	70	F062106023010300	6733677	893	1569	1703	15.2	1.32	60.0
	2600	70	F062106026010300	6733678	1009	1774	1925	17.2	1.32	67.6
	3000	70	6733679		1164	2047	2221	19.8	1.32	77.8
Typ 22										
	400	102	6733162		195	346	375	2.6	1.34	13.8
	500	102	6733163		244	432	469	3.3	1.34	16.8
	600	102	F062206006010300	6733164	293	518	563	4.0	1.34	19.6
	700	102	6733165		342	605	657	4.6	1.34	22.6
	800	102	6733166		391	691	750	5.3	1.34	25.5
	900	102	6733167		440	777	844	5.9	1.34	28.4
	1000	102	6733168		488	864	938	6.6	1.34	31.4
	1100	102	6733169		537	950	1032	7.3	1.34	34.3
	1200	102	6733170		586	1037	1126	7.9	1.34	37.2
	1400	102	6733171		684	1209	1314	9.2	1.34	43.9
	1600	102	6733172		781	1382	1501	10.6	1.34	49.0
	1800	102	6733173		879	1555	1689	11.9	1.34	54.9
	2000	102	6733174		977	1728	1876	13.2	1.34	6.7
	2300	102	6733175		1123	1987	2158	15.2	1.34	69.5
	2600	102	6733176		1270	2246	2439	17.2	1.34	78.3
	3000	102	6733177		1465	2591	2815	19.8	1.34	90.0

Typ 33



600

HÖJD 600 mm	LÄNGD	DJUP	Artikelnr/ RSK (V)	Artikelnr/ RSK (H)	EFFEKT (W) 45/35/20°C	EFFEKT (W) 55/45/20°C	EFFEKT (W) 60/45/20°C	VOLYM (l)	N- EXPONENT	VIKT (kg)
	400	152		6733258	266	473	514	3.9	1.35	2.8
	500	152	F063306005010300	6733259	333	592	643	4.9	1.35	24.5
	600	152		6733260	399	710	772	5.9	1.35	28.9
	700	152		6733261	466	828	900	6.9	1.35	33.3
	800	152		6733262	532	946	1029	7.8	1.35	37.6
	900	152		6733263	599	1065	1157	8.8	1.35	42.2
	1000	152		6733264	665	1183	1286	9.8	1.35	46.4
	1100	152		6733265	732	1301	1415	10.8	1.35	5.9
	1200	152	F063306012010300	6733266	798	1420	1543	11.8	1.35	55.2
	1400	152		6733267	931	1656	1800	13.7	1.35	64.0
	1600	152		6733268	1064	1893	2058	15.7	1.35	72.8
	1800	152		6733269	1197	2129	2315	17.6	1.35	81.5
	2000	152		6733270	1330	2366	2572	19.6	1.35	9.4
	2300	152		6733271	1530	2721	2958	22.5	1.35	105.5
	2600	152		6733272	1730	3076	3344	25.5	1.35	116.7
	3000	152		6733273	1996	3549	3858	29.4	1.35	134.3



900

HÖJD 900 mm	LÄNGD	DJUP	Artikelnr/ RSK (V)	Artikelnr/ RSK (H)	EFFEKT (W) 45/35/20°C	EFFEKT (W) 55/45/20°C	EFFEKT (W) 60/45/20°C	VOLYM (l)	N- EXPONENT	VIKT (kg)
Typ 11										
400	60		6732986		166	291	316	1.8	1.32	11.9
500	60		6732987		208	364	395	2.3	1.32	14.3
600	60	F061109006010300	6732988		249	437	474	2.7	1.32	16.8
700	60		6732989		291	510	553	3.1	1.32	19.2
800	60		6732990		332	583	632	3.6	1.32	21.7
900	60		6732991		373	655	711	4.0	1.32	24.2
1000	60		6732992		415	728	790	4.5	1.32	26.7
1100	60		6732993		457	801	869	5.0	1.32	29.2
1200	60	F061109012010300	6732994		498	874	948	5.4	1.32	31.6
1400	60		6732995		581	1019	1106	6.3	1.32	36.6
1600	60		6732996		664	1165	1264	7.2	1.32	41.6
1800	60		6732997		747	1311	1422	8.1	1.32	46.5
2000	60		6732998		830	1456	1580	9.0	1.32	51.5
2300	60		6732999		955	1675	1817	10.3	1.32	58.9
2600	60		6733000		1079	1893	2054	11.7	1.32	66.4
3000	60	F061109030010300	6733001		1245	2185	2370	13.5	1.32	76.3
Typ 21										
400	70		6733680		212	376	408	3.6	1.34	16.7
500	70	F062109005010300	6733681		265	470	510	4.5	1.34	2.6
600	70		6733682		318	563	612	5.4	1.34	24.3
700	70	F062109007010300	6733683		371	657	714	6.3	1.34	28.6
800	70		6733684		424	751	816	7.2	1.34	31.8
900	70		6733685		477	845	918	8.1	1.34	35.6
1000	70		6733686		530	939	1020	9.0	1.34	39.5
1100	70		6733687		583	1033	1122	9.9	1.34	43.2



900

HÖJD 900 mm	LÄNGD	DJUP	Artikelnr/ RSK (V)	Artikelnr/ RSK (H)	EFFEKT (W) 45/35/20°C	EFFEKT (W) 55/45/20°C	EFFEKT (W) 60/45/20°C	VOLYM (l)	N- EXPONENT	VIKT (kg)
	1200	70		6733688	636	1127	1224	10.8	1.34	47.0
	1400	70	F062109014010300	6733689	742	1315	1428	12.6	1.34	54.5
	1600	70	F062109016010300	6733690	849,848	1502	1632	14.4	1.34	62.8
	1800	70		6733691	954	1690	1836	16.2	1.34	69.6
	2000	70		6733692	1060	1878	2040	18.0	1.34	77.2
	2300	70		6733693	1219	2160	2346	20.7	1.34	88.5
	2600	70		6733694	1379	2442	2653	23.4	1.34	101.8
	3000	70		6733695	1591	2817	3060	27.0	1.34	115.0
Typ 22										
	400	102		6733178	268	478	520	3.6	1.36	19.8
	500	102		6733179	335	597	650	4.5	1.36	24.2
	600	102		6733180	402	717	780	5.4	1.36	28.7
	700	102		6733181	469	836	910	6.3	1.36	33.2
	800	102		6733182	536	956	1039	7.2	1.36	37.7
	900	102		6733183	603	1075	1169	8.1	1.36	42.2
	1000	102		6733184	670	1194	1299	9.0	1.36	46.7
	1100	102		6733185	737	1314	1429	9.9	1.36	51.2
	1200	102		6733186	804	1433	1559	10.8	1.36	55.7
	1400	102		6733187	937	1672	1819	12.6	1.36	64.7
	1600	102		6733188	1071	1911	2079	14.4	1.36	73.7
	1800	102		6733189	1205	2150	2338	16.2	1.36	82.7
	2000	102		6733190	1339	2389	2598	18.0	1.36	91.6
	2300	102	F062209023010300	6733191	1540	2747	2988,2987	20.7	1.36	107.2
	2600	102		6733192	1741	3106	3378	23.4	1.36	118.7
	3000	102		6733193	2009	3583	3897	27.0	1.36	136.6

Typ 33



900

HÖJD 900 mm	LÄNGD	DJUP	Artikelnr/ RSK (V)	Artikelnr/ RSK (H)	EFFEKT (W) 45/35/20°C	EFFEKT (W) 55/45/20°C	EFFEKT (W) 60/45/20°C	VOLYM (l)	N- EXPONENT	VIKT (kg)
	400	152		6733274	364	651	708	5.3	1.36	28.7
	500	152	F063309005010300	6733275	455	814	885	6.7	1.36	35.4
	600	152		6733276	546	976	1062	8.0	1.36	42.9
	700	152		6733277	637	1139	1239	9.3	1.36	48.8
	800	152		6733278	729	1302	1416	10.6	1.36	55.5
	900	152		6733279	820	1465	1593	12.0	1.36	62.3
	1000	152		6733280	911	1627	1770	13.3	1.36	68.9
	1100	152		6733281	1002	1790	1947	14.6	1.36	75.6
	1200	152		6733282	1093	1953	2124	16.0	1.36	82.3
	1400	152	F063309014010300	6733283	1275	2278	2478	19.0	1.36	96.0
	1600	152		6733284	1457	2604	2832	21.3	1.36	111.3
	1800	152		6733285	1639	2929	3187	23.9	1.36	122.6
	2000	152		6733286	1821	3255	3541	26.6	1.36	136.0
	2300	152		6733287	2095	3743	4072	30.6	1.36	156.8
	2600	152		6733288	2368	4231	4603	34.6	1.36	176.2
	3000	152		6733289	2732	4882	5311	39.9	1.36	207.0