



Fișă tehnică
2026-04-01

Ventil Hygiene

Asigură standarde înalte de igienă



- ✓ Standardele ridicate de igienă.
- ✓ Material durabil
- ✓ Rezistent la presiune.
- ✓ Dimensiuni versatile
- ✓ Finisaj rezistent la coroziune

Purmo **Ventil Hygiene** este adaptat pentru locații care necesită cele mai înalte standarde de igienă. Radiatorul este construit fără aripioare convectoare, grile superioare sau panouri laterale, simplificând curățarea și reducând acumularea de praf. Fabricat din oțel laminat la rece și finisat cu un strat rezistent la coroziune, suportă presiuni de operare de până la 10 bar. Disponibil în mai multe dimensiuni, acest radiator asigură performanță termică optimă, respectând standardele de igienă esențiale în facilități medicale și de îngrijire



Domeniu de aplicare

Ventil Hygiene este potrivit pentru medii cu cerințe stricte de igienă, cum ar fi spitale, cămine de bătrâni și medii similare. Este construit fără aripioare convector, grilaj superior și panouri laterale. Date tehnice cheie includ înălțimi de la 300 la 900 mm, lungimi de la 400 la 3000 mm, material din oțel laminat la rece, tratament de suprafață conform DIN 55900 și o presiune maximă de operare de 10 bar.

Dimensionare

Pentru selecția produsului, utilizați serviciul nostru de design sau consultați broșura pentru o selecție rapidă.

Utilizare

Instalați Ventil Hygiene într-o zonă uscată și ventilată, unde poate fi accesat ușor pentru curățare. Asigurați-vă că toate conexiunile sunt sigure și fără scurgeri. Radiatorul trebuie instalat cu suporturi de montare rapidă Purmo sau suporturi Monclac, în funcție de tip. În timpul funcționării, mențineți calitatea apei conform specificațiilor VDI 2035. Urmați ghidurile de asamblare și asigurați-vă că eticheta produsului este orientată spre perete, cu excepția tipului 33, unde este orientată spre exterior.



Specificații

PROPRIETĂȚI	UNITATE	VALORI
ETIM Class		EC011022 - Radiator panel (hidronic)
Material		Oțel
Tip		10, 20, 30
Forma suprafeței		Profilat
Presiune maximă de lucru	Pressure (bar)	10
Număr de conexiuni standard		2
Putere termică conform laboratorului recunoscut EN 442		Da
Culoare standard		Da
Culoare		Alb
Grilă /protecție, laterală		Da
Grilă /protecție, superioară		Da
Cod RAL		9016
Valoarea luciului		Lucios
Dimensiunea filetelui (țoli)		1/2 inch
Conexiune filetată		Filet interior
Cu conexiune într-un singur punct		Da
Cu racord pentru aerisire		Da
Cu ventil de aerisire		Da
Cu opțiune de golire/ scurgere		Da



Documente

DOCUMENTE	TIPUL DOCUMENTULUI	LINK / ADRESA URL
Catalog tehnic - Radiatoare panou, decorative, de baie si ventiloconvectoare	Broșură	https://asset.productmarketingcloud.com/api/assetstorage/3577_6d4f4cea-bede-4142-ae03-963b40b8b294
Instrucțiuni de instalare Purmo Compact	Diagramă tehnică	https://asset.productmarketingcloud.com/api/assetstorage/3577_2da398bb-5820-4a58-af2d-62333aa4e65e



Resurse



Imaginea produsului (HR) - P-Ventil-Compact-Hygiene-2000x2000



Imaginea produsului (HR) - P-Ventil-Hygiene-type10-with-thermostatic-head-2000x2000

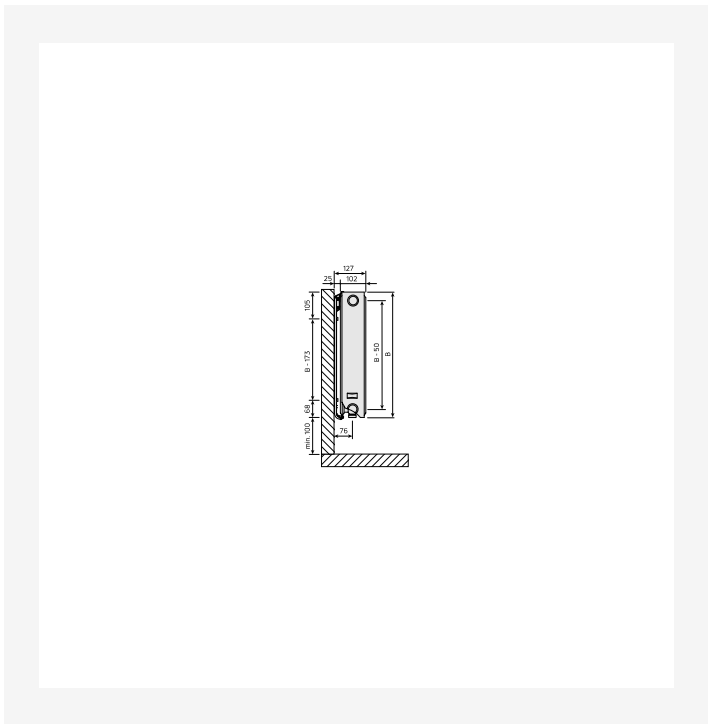

Schiță dimensională - PR-Ventil-Compact-T20-T22-SV-Monclack-3220

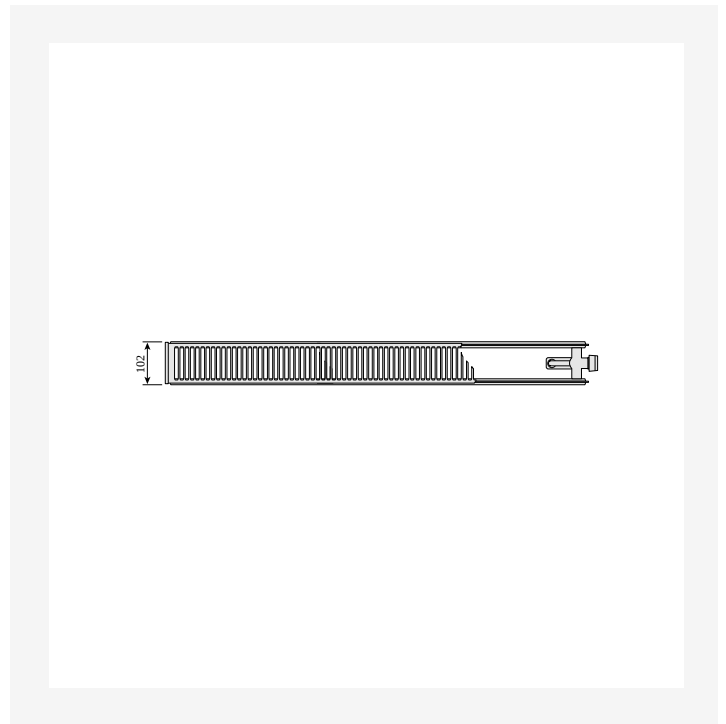

Schiță dimensională - PR-Ventil-Compact-T20-TV-0220



Resurse

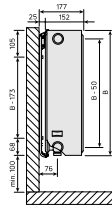

Schiță dimensională - PR-Ventil-Compact-T30-T33-SV1-Monclack-0220

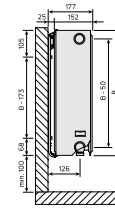

Schiță dimensională - PR-Ventil-Compact-T30-T33-SV2-Monclack-0220

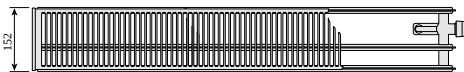

Schiță dimensională - PR-Ventil-Compact-T30-TV1-0220

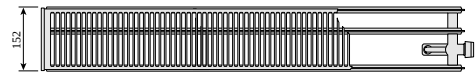

Schiță dimensională - PR-Ventil-Compact-T30-TV2-0220



Resurse

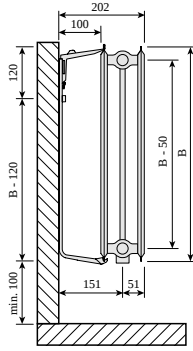

Schiță dimensională - Ventil Hygiene, tip 20, vedere laterala



Schiță dimensională - Ventil Hygiene, tip 30 rotit, vedere de sus

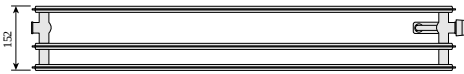

Schiță dimensională - Ventil Hygiene, tip 30 rotit, vedere de sus

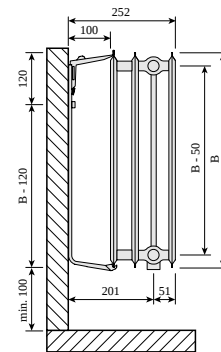

Schiță dimensională - Ventil Hygiene, tip 30 rotit, vedere laterala



Resurse

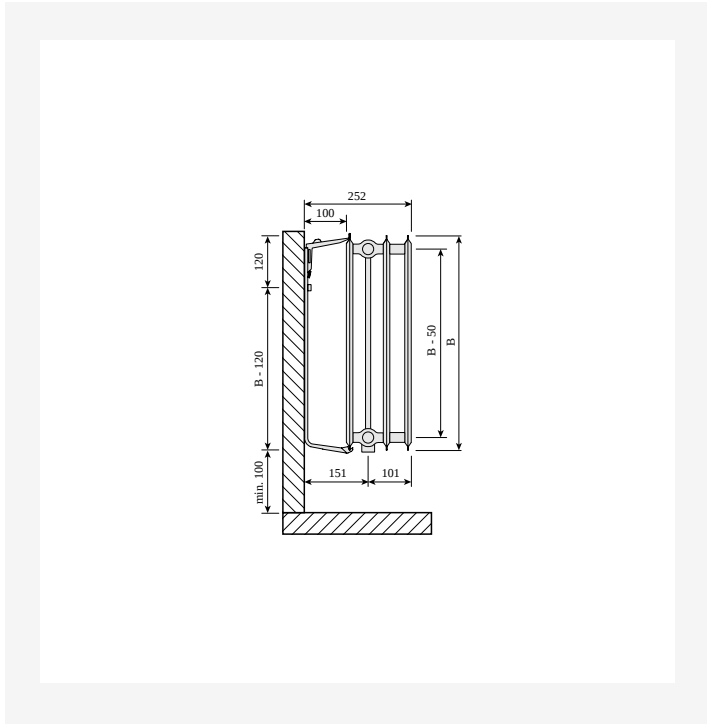

Schiță dimensională - Ventil Hygiene, tip 30 rotit, vedere laterală

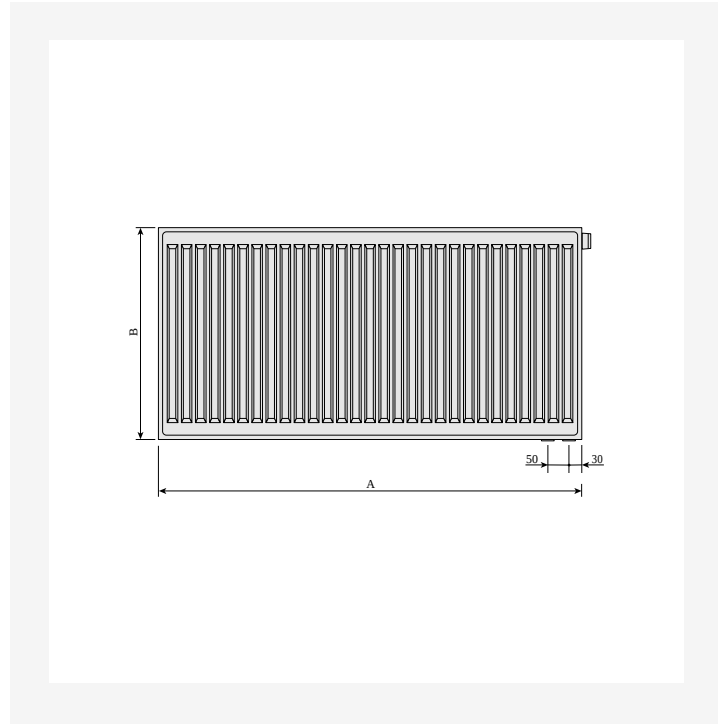

Schiță dimensională - Ventil Hygiene, vedere din fata

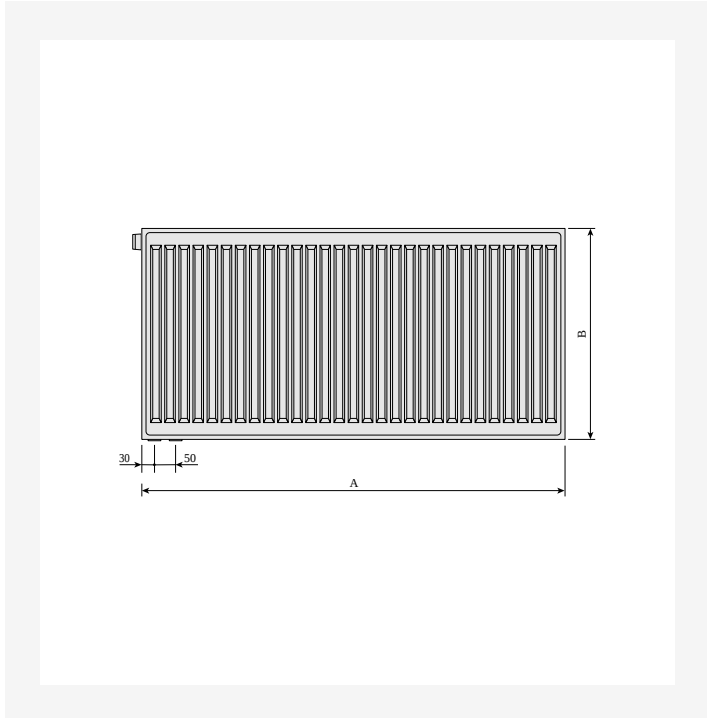

Schiță dimensională - Ventil Hygiene, vedere din spate



300

ÎNĂLȚIME 300 mm	LUNGIME	ADÂNCIME	NR. ARTICOL (STÂNGA)	NR. ARTICOL (DREAPTA)	EFFEKT (W) 45/35/20°C	EFFEKT (W) 55/45/20°C	EFFEKT (W) 75/65/20°C	VOLUM (L)	EXPONENT N	GREUTATE (KG)
Tip 10										
400	47		F071003004001310	F071003004001300	40	70	139	0.7	1.34	3.5
500	47		F071003005001310	F071003005001300	49	88	174	0.8	1.34	4.1
600	47		F071003006001310	F071003006001300	59	105	209	1.0	1.34	4.6
700	47		F071003007001310	F071003007001300	69	123	244	1.2	1.34	5.2
800	47		F071003008001310	F071003008001300	79	140	278	1.4	1.34	5.8
900	47		F071003009001310	F071003009001300	89	158	313	1.5	1.34	6.4
1000	47		F071003010001300		99	175	348	1.7	1.34	7.0
1100	47		F071003011001310	F071003011001300	109	193	383	1.9	1.34	7.6
1200	47		F071003012001310	F071003012001300	119	210	418	2.0	1.34	8.2
1400	47		F071003014001310	F071003014001300	138	245	487	2.4	1.34	9.3
1600	47		F071003016001310	F071003016001300	158	280	557	2.7	1.34	10.5
1800	47		F071003018001310	F071003018001300	178	316	626	3.1	1.34	11.7
2000	47		F071003020001310	F071003020001300	198	351	696	3.4	1.34	12.9
2300	47		F071003023001310	F071003023001300	227	403	800	3.9	1.34	14.6
2600	47		F071003026001310	F071003026001300	257	456	905	4.4	1.34	16.4
3000	47		F071003030001300		297	526	1044	5.1	1.34	18.8
Tip 20										
400	102		F072003004001300		76	131	252	1.4	1.28	5.5
500	102		F072003005001300		95	164	315	1.7	1.28	6.6
600	102		F072003006001300		114	196	378	2.0	1.28	7.7
700	102		F072003007001300		133	229	441	2.4	1.28	8.7
800	102		F072003008001300		152	262	504	2.7	1.28	9.8
900	102		F072003009001300		171	295	567	3.1	1.28	10.8
1000	102		F072003010001300		189	327	630	3.4	1.28	11.9



300

ÎNĂLȚIME 300 mm	LUNGIME	ADÂNCIME	NR. ARTICOL (STÂNGA)	NR. ARTICOL (DREAPTA)	EFFEKT (W) 45/35/20°C	EFFEKT (W) 55/45/20°C	EFFEKT (W) 75/65/20°C	VOLUM (L)	EXPONENT N	GREUTATE (KG)
	1100	102	F072003011001300		208	360	693	3.7	1.28	12.9
	1200	102	F072003012001300		227	393	756	4.1	1.28	14.0
	1400	102	F072003014001300		265	458	882	4.8	1.28	16.1
	1600	102	F072003016001300		303	524	1008	5.4	1.28	18.2
	1800	102	F072003018001300		341	589	1134	6.1	1.28	20.3
	2000	102	F072003020001300		379	655	1260	6.8	1.28	22.4
	2300	102	F072003023001300		436	753	1449	7.8	1.28	25.6
	2600	102	F072003026001300		493	851	1638	8.8	1.28	28.7
	3000	102	F072003030001300		568	982	1890	10.2	1.28	32.9
Tip 30										
	400	152	F073003004001310		104	180	350	2.0	1.30	7.1
	500	152	F073003005001310	F073003005001300	130	225	437	2.5	1.30	8.7
	600	152	F073003006001300		156	271	524	3.1	1.30	10.3
	700	152	F073003007001310	F073003007001300	182	316	612	3.6	1.30	11.9
	800	152	F073003008001310		208	361	699	4.1	1.30	13.5
	900	152	F073003009001310	F073003009001300	233	406	787	4.6	1.30	15.1
	1000	152	F073003010001310	F073003010001300	259	451	874	5.1	1.30	16.7
	1100	152	F073003011001310	F073003011001300	285	496	961	5.6	1.30	18.3
	1200	152	F073003012001310	F073003012001300	311	541	1049	6.1	1.30	19.9
	1400	152	F073003014001310	F073003014001300	363	631	1224	7.1	1.30	23.1
	1600	152	F073003016001310	F073003016001300	415	721	1398	8.2	1.30	26.3
	1800	152	F073003018001310	F073003018001300	467	812	1573	9.2	1.30	29.5
	2000	152	F073003020001310	F073003020001300	519	902	1748	10.2	1.30	32.8
	2300	152	F073003023001310	F073003023001300	597	1037	2010	11.7	1.30	37.5
	2600	152	F073003026001310		674	1172	2272	13.3	1.30	42.4
	3000	152	F073003030001310	F073003030001300	778	1353	2622	15.3	1.30	48.8



400

ÎNĂLȚIME 400 mm	LUNGIME	ADÂNCIME	NR. ARTICOL (STÂNGA)	NR. ARTICOL (DREAPTA)	EFFEKT (W) 45/35/20°C	EFFEKT (W) 55/45/20°C	EFFEKT (W) 75/65/20°C	VOLUM (L)	EXPONENT N	GREUTATE (KG)
Tip 10										
400	47		F071004004001310	F071004004001300	52	91	180	0.9	1.33	4.2
500	47		F071004005001310	F071004005001300	65	114	225	1.1	1.33	5.0
600	47		F071004006001310	F071004006001300	78	137	269	1.3	1.33	5.8
700	47		F071004007001310	F071004007001300	91	160	314	1.5	1.33	6.6
900	47		F071004009001310	F071004009001300	117	205	404	2.0	1.33	8.2
1000	47		F071004010001310	F071004010001300	130	228	449	2.2	1.33	9.0
1100	47		F071004011001310	F071004011001300	143	251	494	2.4	1.33	9.8
1200	47		F071004012001310	F071004012001300	156	274	539	2.6	1.33	10.6
1600	47		F071004016001300		207	365	718	3.5	1.33	13.8
1800	47		F071004018001310		233	411	808	4.0	1.33	15.4
2000	47		F071004020001310	F071004020001300	259	456	898	4.4	1.33	17.0
2300	47		F071004023001310	F071004023001300	298	525	1033	5.1	1.33	19.4
2600	47		F071004026001310	F071004026001300	337	593	1167	5.7	1.33	21.8
3000	47		F071004030001310	F071004030001300	389	684	1347	6.6	1.33	25.0
Tip 20										
500	102		F072004005001300		118	204	394	2.3	1.28	8.2
600	102		F072004006001300		142	245	472	2.7	1.28	9.7
700	102		F072004007001300		165	286	551	3.1	1.28	11.1
800	102		F072004008001300		189	327	630	3.6	1.28	12.5
900	102		F072004009001300		213	368	708	4.0	1.28	13.9
1000	102		F072004010001300		236	409	787	4.5	1.28	15.3
1200	102		F072004012001300		284	490	944	5.4	1.28	18.2
1400	102		F072004014001300		331	572	1102	6.3	1.28	21.0
1600	102		F072004016001300		378	654	1259	7.2	1.28	23.8
1800	102		F072004018001300		425	735	1417	8.1	1.28	26.7



400

ÎNĂLȚIME 400 mm	LUNGIME	ADÂNCIME	NR. ARTICOL (STÂNGA)	NR. ARTICOL (DREAPTA)	EFFEKT (W) 45/35/20°C	EFFEKT (W) 55/45/20°C	EFFEKT (W) 75/65/20°C	VOLUM (L)	EXPONENT N	GREUTATE (KG)
	2000	102	F072004020001300		473	817	1574	9.0	1.28	29.5
	2300	102	F072004023001300		543	940	1810	10.3	1.28	33.8
	2600	102	F072004026001300		614	1062	2046	11.7	1.28	38.1
	3000	102	F072004030001300		709	1226	2361	13.5	1.28	43.7
Tip 30										
	400	152	F073004004001310	F073004004001300	130	226	439	2.7	1.30	9.1
	500	152	F073004005001310	F073004005001300	162	283	549	3.4	1.30	11.2
	600	152	F073004006001310	F073004006001300	195	339	659	4.0	1.30	13.3
	700	152	F073004007001310	F073004007001300	227	396	769	4.7	1.30	15.4
	800	152	F073004008001310	F073004008001300	260	452	878	5.4	1.30	17.5
	900	152	F073004009001310	F073004009001300	292	509	988	6.0	1.30	19.6
	1000	152	F073004010001310	F073004010001300	324	565	1098	6.7	1.30	21.7
	1100	152	F073004011001300		357	622	1208	7.4	1.30	23.8
	1200	152	F073004012001310	F073004012001300	389	678	1318	8.0	1.30	25.9
	1400	152	F073004014001310	F073004014001300	454	791	1537	9.4	1.30	30.1
	1600	152	F073004016001310	F073004016001300	519	904	1757	10.7	1.30	34.3
	1800	152	F073004018001310	F073004018001300	584	1017	1976	12.1	1.30	38.5
	2000	152	F073004020001310	F073004020001300	649	1130	2196	13.4	1.30	42.7
	2300	152	F073004023001310	F073004023001300	746	1300	2525	15.4	1.30	49.0
	2600	152	F073004026001310		844	1469	2855	17.4	1.30	55.3
	3000	152	F073004030001310	F073004030001300	973	1695	3294	20.1	1.30	63.7



450

ÎNĂLȚIME 450 mm	LUNGIME	ADÂNCIME	NR. ARTICOL (STÂNGA)	NR. ARTICOL (DREAPTA)	EFFEKT (W) 45/35/20°C	EFFEKT (W) 55/45/20°C	EFFEKT (W) 75/65/20°C	VOLUM (L)	EXPONENT N	GREUTATE (KG)
Tip 10										
400	47		F071004504001310	F071004504001300	58	102	199	1.0	1.32	4.9
500	47		F071004505001310		72	127	249	1.3	1.32	5.8
600	47		F071004506001310	F071004506001300	87	152	299	1.5	1.32	6.8
700	47		F071004507001310	F071004507001300	101	178	349	1.8	1.32	7.8
800	47		F071004508001310	F071004508001300	116	203	398	2.0	1.32	8.7
900	47		F071004509001310		130	229	448	2.3	1.32	9.7
1000	47		F071004510001310	F071004510001300	145	254	498	2.5	1.32	10.7
1100	47		F071004511001310	F071004511001300	159	280	548	2.8	1.32	11.7
1200	47		F071004512001310	F071004512001300	174	305	598	3.0	1.32	12.6
1400	47		F071004514001310	F071004514001300	203	356	697	3.5	1.32	14.6
1600	47		F071004516001310	F071004516001300	232	407	797	4.0	1.32	16.5
1800	47		F071004518001310	F071004518001300	261	457	896	4.5	1.32	18.4
2000	47		F071004520001310	F071004520001300	290	508	996	5.0	1.32	20.4
2300	47		F071004523001310	F071004523001300	333	584	1145	5.8	1.32	23.3
2600	47		F071004526001310		377	661	1295	6.5	1.32	26.2
3000	47		F071004530001310	F071004530001300	435	762	1494	7.5	1.32	30.0
Tip 20										
400	102		F072004504001300		104	179	345	2.0	1.28	8.1
500	102		F072004505001300		129	224	432	2.5	1.28	9.8
600	102		F072004506001300		155	269	518	3.0	1.28	11.5
700	102		F072004507001300		181	313	604	3.5	1.28	13.2
800	102		F072004508001300		207	358	690	4.0	1.28	14.9
900	102		F072004509001300		233	403	777	4.5	1.28	16.6
1000	102		F072004510001300		259	448	863	5.0	1.28	18.3
1100	102		F072004511001300		285	493	949	5.5	1.28	20.0



450

ÎNĂLȚIME 450 mm	LUNGIME	ADÂNCIME	NR. ARTICOL (STÂNGA)	NR. ARTICOL (DREAPTA)	EFFEKT (W) 45/35/20°C	EFFEKT (W) 55/45/20°C	EFFEKT (W) 75/65/20°C	VOLUM (L)	EXPONENT N	GREUTATE (KG)
1200	102		F072004512001300		311	537	1036	6.0	1.28	21.7
1400	102		F072004514001300		362	627	1208	7.0	1.28	25.1
1600	102		F072004516001300		414	716	1381	8.0	1.28	28.5
1800	102		F072004518001300		466	806	1553	9.0	1.28	31.9
2000	102		F072004520001300		518	895	1726	10.0	1.28	35.3
2300	102		F072004523001300		595	1030	1985	11.5	1.28	40.4
3000	102		F072004530001300		776	1343	2589	15.0	1.28	52.3
Tip 30										
400	152		F073004504001300		142	248	482	3.0	1.30	10.6
500	152		F073004505001310	F073004505001300	178	310	603	3.8	1.30	13.2
600	152		F073004506001310	F073004506001300	213	372	723	4.5	1.30	15.8
700	152		F073004507001300		249	434	844	5.3	1.30	18.4
800	152		F073004508001310	F073004508001300	284	496	964	6.0	1.30	21.0
900	152		F073004509001300		320	557	1085	6.8	1.30	23.5
1000	152		F073004510001310	F073004510001300	355	619	1205	7.5	1.30	26.2
1100	152		F073004511001300		391	681	1326	8.3	1.30	28.8
1200	152		F073004512001310	F073004512001300	426	743	1446	9.0	1.30	31.4
1400	152		F073004514001310	F073004514001300	497	867	1687	10.5	1.30	36.5
1600	152		F073004516001310	F073004516001300	568	991	1928	12.0	1.30	41.7
1800	152		F073004518001310	F073004518001300	639	1115	2169	13.5	1.30	46.9
2000	152		F073004520001310	F073004520001300	711	1239	2410	15.0	1.30	52.1
2300	152		F073004523001310		817	1425	2772	17.3	1.30	59.9
2600	152		F073004526001310	F073004526001300	924	1610	3133	19.5	1.30	67.7
3000	152		F073004530001300		1066	1858	3615	22.5	1.30	78.1



500

ÎNĂLȚIME 500 mm	LUNGIME	ADÂNCIME	NR. ARTICOL (STÂNGA)	NR. ARTICOL (DREAPTA)	EFFEKT (W) 45/35/20°C	EFFEKT (W) 55/45/20°C	EFFEKT (W) 75/65/20°C	VOLUM (L)	EXPONENT N	GREUTATE (KG)
Tip 10										
400	47		F071005004001310	F071005004001300	64	112	218	1.1	1.31	5.1
500	47		F071005005001310	F071005005001300	80	140	273	1.4	1.31	6.1
600	47		F071005006001310	F071005006001300	96	168	328	1.6	1.31	7.0
700	47		F071005007001310	F071005007001300	112	196	382	1.9	1.31	8.0
800	47		F071005008001310	F071005008001300	128	224	437	2.2	1.31	9.0
900	47		F071005009001300		144	252	491	2.4	1.31	9.9
1000	47		F071005010001310	F071005010001300	160	280	546	2.7	1.31	10.9
1100	47		F071005011001310	F071005011001300	176	308	601	3.0	1.31	11.9
1200	47		F071005012001310	F071005012001300	192	336	655	3.2	1.31	12.8
1400	47		F071005014001310	F071005014001300	224	392	764	3.8	1.31	14.8
1600	47		F071005016001310		256	448	874	4.3	1.31	16.7
1800	47		F071005018001310	F071005018001300	288	504	983	4.9	1.31	18.6
2000	47		F071005020001310	F071005020001300	320	560	1092	5.4	1.31	20.6
2300	47		F071005023001300		368	644	1256	6.2	1.31	23.5
2600	47		F071005026001310	F071005026001300	416	728	1420	7.0	1.31	26.4
3000	47		F071005030001310	F071005030001300	480	839	1638	8.1	1.31	30.2
Tip 20										
400	102		F072005004001300		112	195	375	2.2	1.29	8.3
500	102		F072005005001300		141	243	469	2.8	1.29	10.1
600	102		F072005006001300		169	292	563	3.3	1.29	11.8
700	102		F072005007001300		197	340	657	3.9	1.29	13.5
800	102		F072005008001300		225	389	750	4.4	1.29	15.3
900	102		F072005009001300		253	438	844	5.0	1.29	17.0
1000	102		F072005010001300		281	486	938	5.5	1.29	18.7
1100	102		F072005011001300		309	535	1032	6.0	1.29	20.5



500

ÎNĂLȚIME 500 mm	LUNGIME	ADÂNCIME	NR. ARTICOL (STÂNGA)	NR. ARTICOL (DREAPTA)	EFFEKT (W) 45/35/20°C	EFFEKT (W) 55/45/20°C	EFFEKT (W) 75/65/20°C	VOLUM (L)	EXPONENT N	GREUTATE (KG)
	1200	102	F072005012001300		337	584	1126	6.6	1.29	22.2
	1400	102	F072005014001300		393	681	1313	7.7	1.29	25.7
	1600	102	F072005016001300		450	778	1501	8.8	1.29	29.1
	1800	102	F072005018001300		506	876	1688	9.9	1.29	32.6
	2300	102	F072005023001300		646	1119	2157	12.7	1.29	41.2
	2600	102	F072005026001300		731	1265	2439	14.3	1.29	46.4
Tip 30										
	400	152	F073005004001310		154	269	524	3.3	1.31	10.6
	500	152	F073005005001310	F073005005001300	193	336	655	4.1	1.31	13.3
	600	152	F073005006001310	F073005006001300	231	403	785	4.9	1.31	16.0
	700	152	F073005007001310	F073005007001300	270	470	916	5.7	1.31	18.6
	800	152	F073005008001310	F073005008001300	308	538	1047	6.6	1.31	21.3



600

ÎNĂLȚIME 600 mm	LUNGIME	ADÂNCIME	NR. ARTICOL (STÂNGA)	NR. ARTICOL (DREAPTA)	EFFEKT (W) 45/35/20°C	EFFEKT (W) 55/45/20°C	EFFEKT (W) 75/65/20°C	VOLUM (L)	EXPONENT N	GREUTATE (KG)
Tip 10										
400	47		F071006004001310	F071006004001300	76	132	256	1.3	1.29	6.0
500	47		F071006005001310	F071006005001300	95	165	320	1.6	1.29	7.2
600	47		F071006006001300		114	198	383	1.9	1.29	8.4
700	47		F071006007001310	F071006007001300	133	231	447	2.2	1.29	9.6
800	47		F071006008001310	F071006008001300	152	264	511	2.6	1.29	10.8
900	47		F071006009001310	F071006009001300	171	297	575	2.9	1.29	12.0
1000	47		F071006010001310	F071006010001300	190	330	639	3.2	1.29	13.2
1100	47		F071006011001310	F071006011001300	209	363	703	3.5	1.29	14.4
1200	47		F071006012001300		228	396	767	3.8	1.29	15.6
1400	47		F071006014001310	F071006014001300	267	462	895	4.5	1.29	18.0
1600	47		F071006016001310	F071006016001300	305	529	1022	5.1	1.29	20.4
1800	47		F071006018001310	F071006018001300	343	595	1150	5.8	1.29	22.8
2000	47		F071006020001310	F071006020001300	381	661	1278	6.4	1.29	25.2
2300	47		F071006023001310		438	760	1470	7.4	1.29	28.8
2600	47		F071006026001310	F071006026001300	495	859	1661	8.3	1.29	32.3
3000	47		F071006030001310	F071006030001300	571	991	1917	9.6	1.29	37.1



900

ÎNĂLȚIME 900 mm	LUNGIME	ADÂNCIME	NR. ARTICOL (STÂNGA)	NR. ARTICOL (DREAPTA)	EFFEKT (W) 45/35/20°C	EFFEKT (W) 55/45/20°C	EFFEKT (W) 75/65/20°C	VOLUM (L)	EXPONENT N	GREUTATE (KG)
Tip 10										
400	47		F071009004001310	F071009004001300	107	186	361	1.8	1.30	8.2
500	47		F071009005001310	F071009005001300	134	233	452	2.3	1.30	10.0
600	47		F071009006001310	F071009006001300	160	279	542	2.7	1.30	11.8
700	47		F071009007001310	F071009007001300	187	326	632	3.1	1.30	13.6
800	47		F071009008001310	F071009008001300	214	372	722	3.6	1.30	15.4
900	47		F071009009001310		240	419	813	4.0	1.30	17.2
1000	47		F071009010001310	F071009010001300	267	465	903	4.5	1.30	19.0
1100	47		F071009011001310	F071009011001300	294	512	993	5.0	1.30	20.8
1200	47		F071009012001310	F071009012001300	321	558	1084	5.4	1.30	22.6
1400	47		F071009014001310	F071009014001300	374	651	1264	6.3	1.30	26.1
1600	47		F071009016001310		428	744	1445	7.2	1.30	29.7
1800	47		F071009018001310	F071009018001300	481	837	1625	8.1	1.30	33.3
2000	47		F071009020001310	F071009020001300	534	930	1806	9.0	1.30	36.9
2300	47		F071009023001310	F071009023001300	615	1070	2077	10.3	1.30	42.2
2600	47		F071009026001310	F071009026001300	695	1209	2348	11.7	1.30	47.6
3000	47		F071009030001310	F071009030001300	802	1395	2709	13.5	1.30	54.8



1000

ÎNĂLȚIME 1000 mm	LUNGIME	ADÂNCIME	NR. ARTICOL (STÂNGA)	NR. ARTICOL (DREAPTA)	EFFEKT (W) 45/35/20°C	EFFEKT (W) 55/45/20°C	EFFEKT (W) 75/65/20°C	VOLUM (L)	EXPONENT N	GREUTATE (KG)
Tip 20										
0	100		F072009004001300	F072006004001300	179,130	311,225	606,434	3.6	1.30	13.8
1000	100		F072009005001300	F072006011001300	357,223	618,389	758,194	7.3	1.30	25.3
2000	100		F072006020001300	F072006018001300	649,584	1124,1012	2170,1953	13.2	1.29	45.0
3000	100		F072009026001300	F072006026001300	844,1161	2025,1461	3942,2821	23.4	1.30	81.8
Tip 30										
0	150		F073006004001310	F073006004001300	177	309	604	3.9	1.31	12.9
1000	150		F073005010001300	F073005009001300	385,347	672,605	1309,1178	8.2	1.31	26.6
2000	150		F073005018001300	F073005016001300	693,616	1210,1075	2356,2094	14.8	1.31	48.0
3000	150		F073005026001310	F073005026001300	1001	1747	3403	21.3	1.31	69.3