



Fișă tehnică
2026-06-28

Plan Hygiene

Radiator ideal pentru medii cu igienă ridicată Plan Hygiene



- ✓ Ușor de curățat și întreținut
- ✓ Standard ridicat de igienă
- ✓ Construcție durabilă
- ✓ Încălzire eficientă
- ✓ Design estetic și modern

Radiatoarele **Plan Hygiene** sunt proiectate pentru medii cu cerințe stricte de igienă. Ele au o suprafață elegantă, ușor de curățat, fără aripioare convectoare, grile superioare și panouri laterale, fiind foarte potrivite pentru spitale și clinici. Radiatorul susține o putere termică eficientă de căldură, minimizând locurile unde murdăria și bacteriile se pot acumula. Disponibil în diverse dimensiuni, se integrează perfect în diferite spații, îndeplinind nevoi funcționale și estetice. Durabil și ușor de întreținut, Plan Hygiene asigură o atmosferă igienică și sigură.



Domeniu de aplicare

Plan Hygiene este ideal pentru spații care necesită standarde stricte de igienă, cum ar fi spitale, clinici și alte facilități de sănătate. Suprafața sa netedă și designul deschis asigură ușurința curățării, fiind perfect pentru medii unde condițiile aseptice sunt esențiale.

Dimensionare

Pentru o selecție optimă a produsului, evaluați cerințele specifice de igienă și constrângerile dimensionale. Pentru o selecție rapidă, folosiți broșura noastră sau consultați serviciul nostru de design.

Utilizare

Instalați radiatoarele Plan Hygiene conform practicilor standard de instalații sanitare, asigurându-vă că eticheta produsului este orientată spre perete. Întreținerea regulată implică ștergerea suprafeței cu agenți de curățare aprobați. Manevrați cu grijă pentru a evita deteriorarea suprafeței netede. Asigurați-vă că radiatorul funcționează în limitele de presiune și temperatură specificate. Efectuați întotdeauna verificări de rutină pentru performanță optimă și conformitate cu siguranța.



Specificații

PROPRIETĂȚI	UNITATE	VALORI
ETIM Class		EC011022
Material		Oțel
Tip		10, 20, 30
Forma suprafeței		Plat neted
Presiune maximă de lucru	bar	10
Număr de conexiuni standard		4
Putere termică conform laboratorului recunoscut EN 442		Da
Temperatura maximă de operare	°C	110
Culoare standard		Da
Culoare		Alb
Cod RAL		9016
Grilă /protecție, laterală		Da
Grilă /protecție, superioară		Da
Valoarea luciului		Lucios
Dimensiunea filetului (țoli)		1/2 inch
Conexiune filetată		Filet interior
Cu conexiune într-un singur punct		Da
Cu racord pentru aerisire		Da
Cu ventil de aerisire		Da
Cu opțiuni de golire/ scurgere		Da



Documente

DOCUMENTE	TIPUL DOCUMENTULUI	LINK / ADRESA URL
Catalog tehnic - Radiatoare panou, decorative, de baie si ventiloconvectoare	Brochure	https://asset.productmarketingcloud.com/api/assetstorage/3577_aeba8a24-faa1-4941-ac96-483732f0a7cf
Instrucțiuni de instalare Purmo Compact	TechDia	https://asset.productmarketingcloud.com/api/assetstorage/3577_2da398bb-5820-4a58-af2d-62333aa4e65e



Resurse



ProductImage - Panel radiator Plan Hygiene, FH.



ProductImage - Plan Compact Hygiene

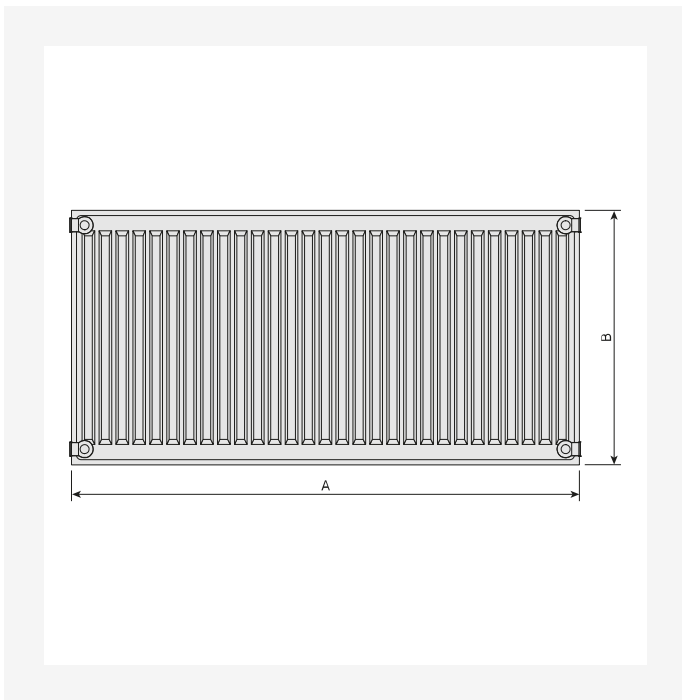

DimensionalDrawing - Plan Hygiene

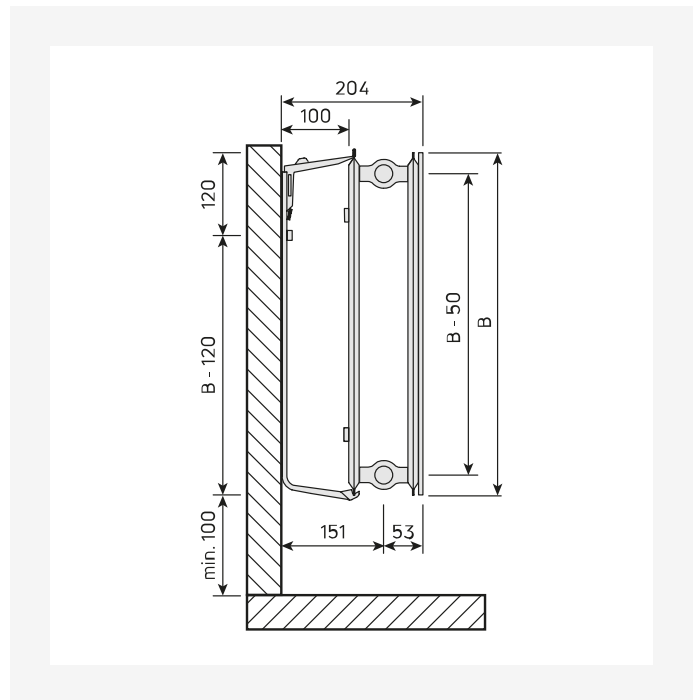

DimensionalDrawing - Plan Hygiene, tip 20, vedere laterala



Resurse

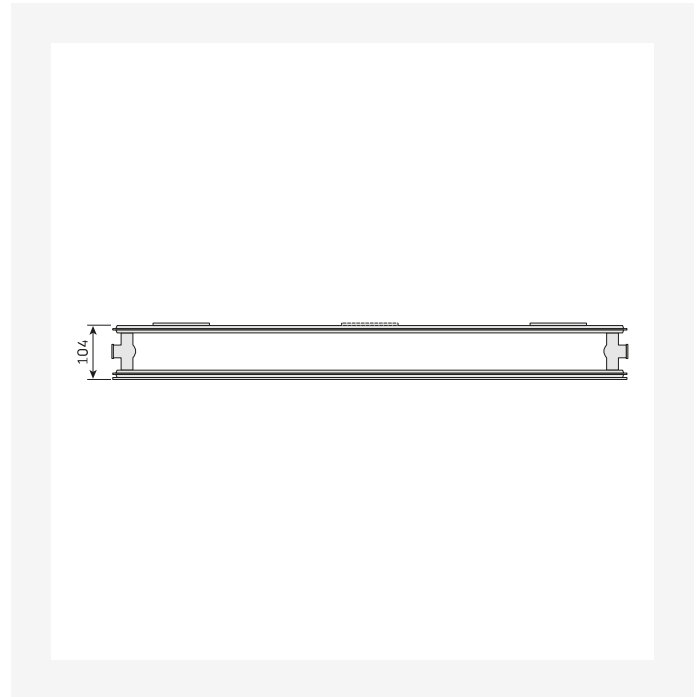
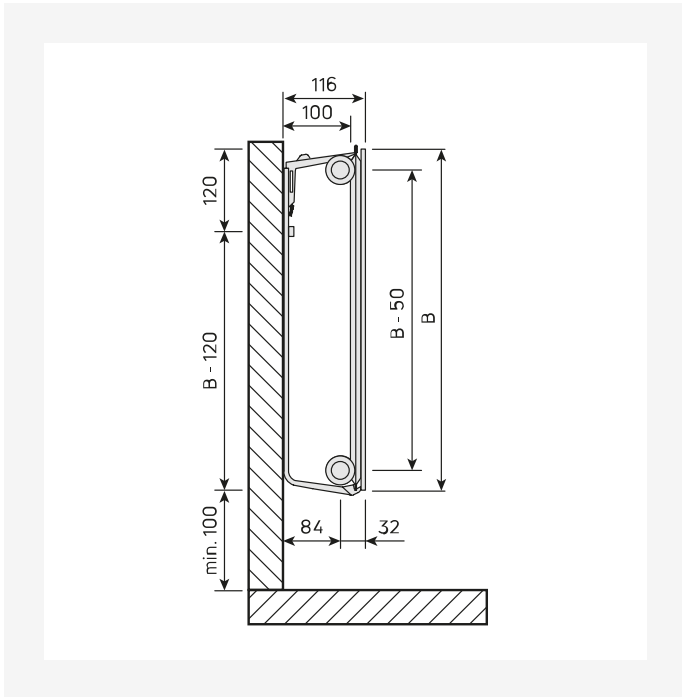

DimensionalDrawing - Plan Hygiene, tip 10, vedere laterala

DimensionalDrawing - Plan Hygiene, tip 20, vedere de sus

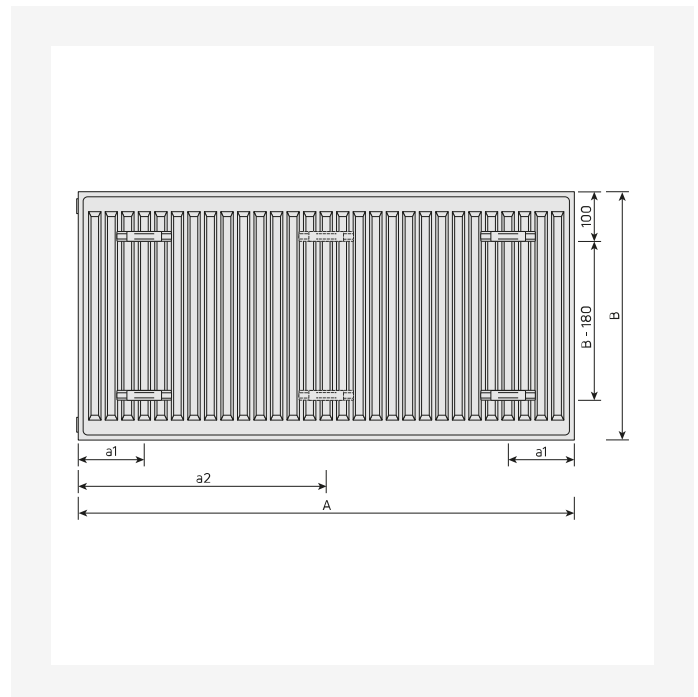
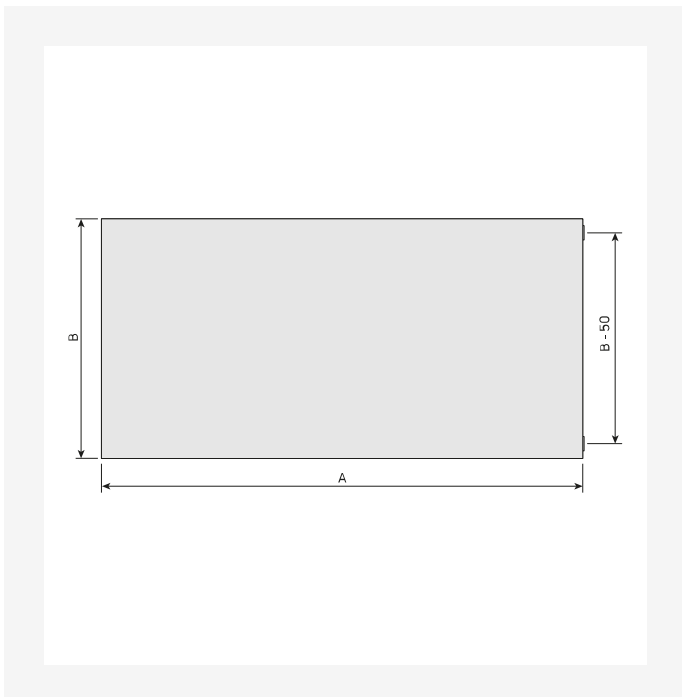

DimensionalDrawing - Plan Hygiene, vedere din fata

DimensionalDrawing - Plan Hygiene, vedere din spate



Resurse

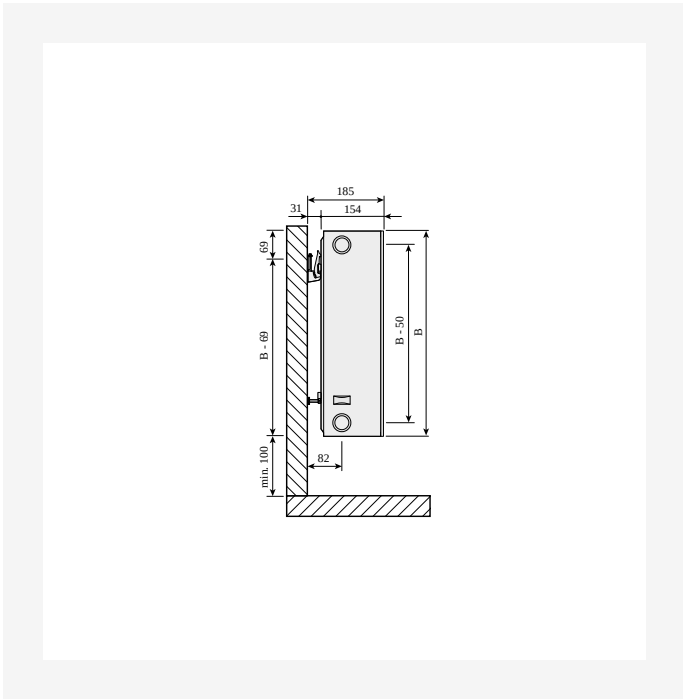

DimensionalDrawing - Plan Compact, Ramo Compact type33, SV SSMS

DimensionalDrawing - Hygiene Plan Compact, t30 TV

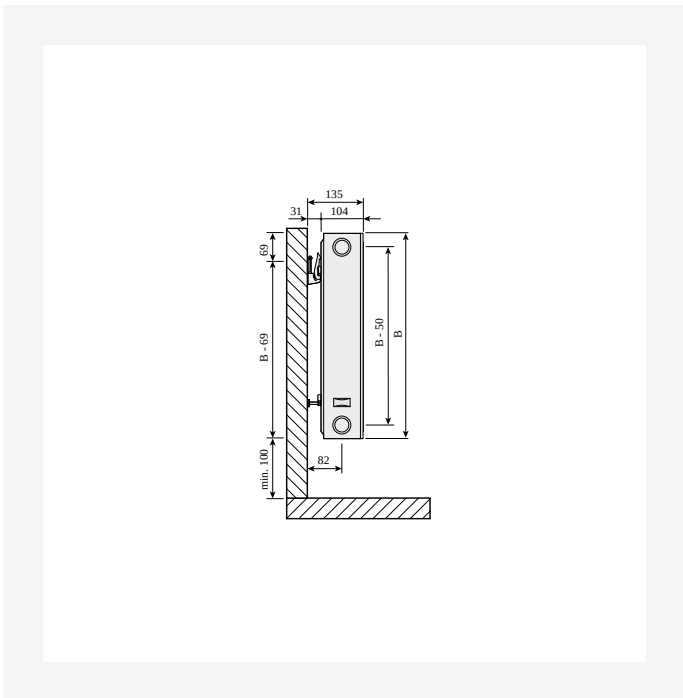

DimensionalDrawing - Plan Compact, Ramo Compact type 22, side view with SSMS wall brackets.

DimensionalDrawing - Hygiene Plan Compact t20, TV



Produse similare



Grilă superioară



Vopsea pentru retușare



Laterale



300

ÎNĂLȚIME 300 mm	LUNGIME	ADÂNCIME	NR. ARTICOL (STÂNGA)	NR. ARTICOL (DREAPTA)	EFFEKT (W) 45/35/20°C	EFFEKT (W) 55/45/20°C	EFFEKT (W) 75/65/20°C	VOLUM (L)	EXPONENT N	GREUTATE (KG)
Tip 10										
400	49		F091003004001300	F091003004000300	37	64	125	0.7	1.31	4.4
500	49		F091003005001300	F091003005000300	46	80	157	0.8	1.31	5.3
600	49		F091003006001300	F091003006000300	55	96	188	1.0	1.31	6.2
700	49		F091003007001300	F091003007000300	64	112	219	1.2	1.31	7.0
800	49		F091003008001300	F091003008000300	74,73	128	250	1.4	1.31	7.9
900	49		F091003009001300	F091003009000300	83	144	282	1.5	1.31	8.7
1000	49		F091003010001300	F091003010000300	92	161	313	1.7	1.31	9.6
1100	49		F091003011001300	F091003011000300	101	177	344	1.9	1.31	10.4
1200	49		F091003012001300	F091003012000300	110	193	376	2.0	1.31	11.3
1400	49		F091003014001300	F091003014000300	129	225	438	2.4	1.31	12.9
1600	49		F091003016001300	F091003016000300	147	257	501	2.7	1.31	14.6
1800	49		F091003018001300	F091003018000300	165	289	563	3.1	1.31	16.3
2000	49		F091003020001300	F091003020000300	184	321	626	3.4	1.31	18.4
2300	49		F091003023001300	F091003023000300	211	369	720	3.9	1.31	21.0
2600	49		F091003026001300	F091003026000300	239	417	814	4.4	1.31	23.6
3000	49		F091003030001300	F091003030000300	276	482	939	5.1	1.31	27.1
Tip 20										
400	104			F092003004000300	73	125	239	1.4	1.27	6.1
500	104			F092003005000300	91	156	299	1.7	1.27	7.5
600	104			F092003006000300	109	187	359	2.0	1.27	8.8
700	104			F092003007000300	127	219	419	2.4	1.27	1.1
800	104			F092003008000300	145	250	478	2.7	1.27	11.5
900	104			F092003009000300	164	281	538	3.1	1.27	12.8
1000	104			F092003010000300	182	312	598	3.4	1.27	14.1



300

ÎNĂLȚIME 300 mm	LUNGIME	ADÂNCIME	NR. ARTICOL (STÂNGA)	NR. ARTICOL (DREAPTA)	EFFEKT (W) 45/35/20°C	EFFEKT (W) 55/45/20°C	EFFEKT (W) 75/65/20°C	VOLUM (L)	EXPONENT N	GREUTATE (KG)
	1100	104	F092003011000300		200	344	658	3.7	1.27	15.5
	1400	104	F092003014000300		254	437	837	4.8	1.27	19.4
	1600	104	F092003016000300		291	500	957	5.4	1.27	22.5
	1800	104	F092003018000300		327	562	1076	6.1	1.27	24.7
	2300	104	F092003023000300		418	719	1375	7.8	1.27	31.4
	2600	104	F092003026000300		472	812	1555	8.8	1.27	35.4
	3000	104	F092003030000300		545	937	1794	10.2	1.27	4.8
Tip 30										
	400	154	F093003004000300		99	172	334	2.0	1.29	7.7
	500	154	F093003005000300		124	215	417	2.5	1.29	9.5
	600	154	F093003006000300		149	259	500	3.1	1.29	11.4
	700	154	F093003007000300		174	302	584	3.6	1.29	13.2
	800	154	F093003008000300		199	345	667	4.1	1.29	15.1
	900	154	F093003009000300		223	388	751	4.6	1.29	16.9
	1000	154	F093003010000300		248	431	834	5.1	1.29	18.9
	1100	154	F093003011000300		273	474	917	5.6	1.29	2.7
	1200	154	F093003012000300		298	517	1001	6.1	1.29	22.6
	1400	154	F093003014000300		348	603	1168	7.1	1.29	26.2
	1600	154	F093003016000300		397	689	1334	8.2	1.29	29.9
	1800	154	F093003018000300		447	776	1501	9.2	1.29	33.6
	2000	154	F093003020000300		496	862	1668	10.2	1.29	37.3
	2600	154	F093003026000300		645	1120	2168	13.3	1.29	48.4
	3000	154	F093003030000300		745	1293	2502	15.3	1.29	55.8



400

ÎNĂLȚIME 400 mm	LUNGIME	ADÂNCIME	NR. ARTICOL	EFFEKT (W) 45/35/20°C	EFFEKT (W) 55/45/20°C	EFFEKT (W) 75/65/20°C	VOLUM (L)	EXPONENT N	GREUTATE (KG)
Tip 10									
400	49		F091004004001300	49	85	165	0.9	1.29	5.5
500	49		F091004005001300	61	106	206	1.1	1.29	6.7
600	49		F091004006001300	73	128	247	1.3	1.29	7.8
700	49		F091004007001300	86	149	288	1.5	1.29	9.0
800	49		F091004008001300	98	170	330	1.8	1.29	10.1
900	49		F091004009001300	110	192	371	2.0	1.29	11.2
1000	49		F091004010001300	123	213	412	2.2	1.29	12.3
1100	49		F091004011001300	135	234	453	2.4	1.29	13.5
1200	49		F091004012001300	147	255	494	2.6	1.29	14.6
1400	49		F091004014001300	172	298	577	3.1	1.29	16.9
1600	49		F091004016001300	196	341	659	3.5	1.29	19.1
1800	49		F091004018001300	221	383	742	4.0	1.29	21.4
2000	49		F091004020001300	245	426	824	4.4	1.29	23.7



500

ÎNĂLȚIME 500 mm	LUNGIME	ADÂNCIME	NR. ARTICOL (STÂNGA)	NR. ARTICOL (DREAPTA)	EFFEKT (W) 45/35/20°C	EFFEKT (W) 55/45/20°C	EFFEKT (W) 75/65/20°C	VOLUM (L)	EXPONENT N	GREUTATE (KG)
Tip 10										
400	49		F091005004001300	F091005004000300	61	105	202	1.1	1.28	6.5
500	49		F091005005001300	F091005005000300	76	131	253	1.4	1.28	8.0
600	49		F091005006001300	F091005006000300	91	158	303	1.6	1.28	9.5
700	49		F091005007001300	F091005007000300	107	184	354	1.9	1.28	10.9
800	49		F091005008001300	F091005008000300	122	210	404	2.2	1.28	12.3
900	49		F091005009001300	F091005009000300	137	236	455	2.4	1.28	13.7
1000	49		F091005010001300	F091005010000300	152	263	505	2.7	1.28	15.4
1100	49		F091005011001300	F091005011000300	168,167	289	556	3.0	1.28	16.5
1200	49		F091005012001300	F091005012000300	183	315	606	3.2	1.28	18.0
1400	49		F091005014001300	F091005014000300	213	368	707	3.8	1.28	20.6
1600	49		F091005016001300	F091005016000300	244	420	808	4.3	1.28	23.7
1800	49		F091005018001300	F091005018000300	274	473	909	4.9	1.28	26.6
2000	49		F091005020001300	F091005020000300	304	526	1010	5.4	1.28	29.5
2300	49		F091005023001300	F091005023000300	350	604	1162	6.2	1.28	34.5
2600	49		F091005026001300	F091005026000300	396	683	1313	7.0	1.28	38.9
3000	49		F091005030001300	F091005030000300	457	788	1515	8.1	1.28	44.8
Tip 20										
400	104			F092005004000300	106	183	352	2.2	1.28	9.3
600	104			F092005006000300	159	274	528	3.3	1.28	13.7
700	104			F092005007000300	185	320	616	3.9	1.28	15.8
800	104			F092005008000300	212	366	704	4.4	1.28	18.0
900	104			F092005009000300	238	412	792	5.0	1.28	2.2
1000	104			F092005010000300	265	457	880	5.5	1.28	22.3
1100	104			F092005011000300	291	503	968	6.0	1.28	24.5
1200	104			F092005012000300	318	549	1056	6.6	1.28	26.7



500

ÎNĂLȚIME 500 mm	LUNGIME	ADÂNCIME	NR. ARTICOL (STÂNGA)	NR. ARTICOL (DREAPTA)	EFFEKT (W) 45/35/20°C	EFFEKT (W) 55/45/20°C	EFFEKT (W) 75/65/20°C	VOLUM (L)	EXPONENT N	GREUTATE (KG)
	1400	104	F092005014000300		371	640	1232	7.7	1.28	31.1
	1600	104	F092005016000300		424	732	1408	8.8	1.28	35.3
	1800	104	F092005018000300		477	823	1584	9.9	1.28	39.7
	2000	104	F092005020000300		530	915	1760	11.0	1.28	44.1
	2300	104	F092005023000300		609	1052	2024	12.7	1.28	5.5
	2600	104	F092005026000300		689	1189	2288	14.3	1.28	57.5
	3000	104	F092005030000300		794	1372	2640	16.5	1.28	65.7
Tip 30	400	154	F093005004000300		144	251	488	3.3	1.30	11.7
	500	154	F093005005000300		180	313	610	4.1	1.30	14.8
	600	154	F093005006000300		216	376	731	4.9	1.30	17.8
	700	154	F093005007000300		252	439	853	5.7	1.30	2.8
	800	154	F093005008000300		288	501	975	6.6	1.30	23.8
	900	154	F093005009000300		324	564	1097	7.4	1.30	26.9
	1000	154	F093005010000300		360	627	1219	8.2	1.30	30.0
	1100	154	F093005011000300		396	689	1341	9.0	1.30	32.9
	1200	154	F093005012000300		431	752	1463	9.8	1.30	36.0
	1400	154	F093005014000300		503	877	1707	11.5	1.30	42.0
	1600	154	F093005016000300		575	1003	1950	13.1	1.30	48.5
	1800	154	F093005018000300		647	1128	2194	14.8	1.30	54.9
	2000	154	F093005020000300		719	1253	2438	16.4	1.30	6.2
	2300	154	F093005023000300		827	1442	2804	18.9	1.30	69.3
	2600	154	F093005026000300		935	1630	3169	21.3	1.30	78.3
	3000	154	F093005030000300		1079	1880	3657	24.6	1.30	9.4



600

ÎNĂLȚIME 600 mm	LUNGIME	ADÂNCIME	NR. ARTICOL (STÂNGA)	NR. ARTICOL (DREAPTA)	EFEKT (W) 45/35/20°C	EFEKT (W) 55/45/20°C	EFEKT (W) 75/65/20°C	VOLUM (L)	EXPONENT N	GREUTATE (KG)
Tip 10										
400	49		F091006004001300	F091006004000300	72	124	237	1.3	1.26	8.0
500	49		F091006005001300	F091006005000300	90	155	296	1.6	1.26	9.7
600	49		F091006006001300	F091006006000300	109,108	186	355	1.9	1.26	11.4
700	49		F091006007001300	F091006007000300	127,126	217	414	2.2	1.26	13.2
800	49		F091006008001300	F091006008000300	145	248	474	2.6	1.26	14.8
900	49		F091006009001300	F091006009000300	163	279	533	2.9	1.26	16.5
1000	49		F091006010001300	F091006010000300	181	310	592	3.2	1.26	18.2
1100	49		F091006011001300	F091006011000300	199	341	651	3.5	1.26	19.9
1200	49		F091006012001300	F091006012000300	217	372	710	3.8	1.26	21.6
1400	49		F091006014001300	F091006014000300	253	434	829	4.5	1.26	25.3
1600	49		F091006016001300	F091006016000300	289	496	947	5.1	1.26	28.5
1800	49		F091006018001300	F091006018000300	326	558	1066	5.8	1.26	31.9
2000	49		F091006020001300	F091006020000300	362	621	1184	6.4	1.26	35.3
2300	49		F091006023001300	F091006023000300	416	714	1362	7.4	1.26	41.3
2600	49		F091006026001300	F091006026000300	470	807	1539	8.3	1.26	46.5
3000	49		F091006030001300	F091006030000300	543,542	931	1776	9.6	1.26	53.5
Tip 20										
400	104			F092006004000300	122	210	406	2.6	1.29	11.5
500	104			F092006005000300	152	263	508	3.3	1.29	14.2
600	104			F092006006000300	182	316	609	4.0	1.29	16.8
800	104			F092006008000300	243	421	812	5.3	1.29	22.1
900	104			F092006009000300	274	474	914	5.9	1.29	24.8
1000	104			F092006010000300	304	526	1015	6.6	1.29	27.4
1100	104			F092006011000300	334	579	1117	7.3	1.29	3.9
1200	104			F092006012000300	365	631	1218	7.9	1.29	32.7



600

ÎNĂLȚIME 600 mm	LUNGIME	ADÂNCIME	NR. ARTICOL (STÂNGA)	NR. ARTICOL (DREAPTA)	EFFEKT (W) 45/35/20°C	EFFEKT (W) 55/45/20°C	EFFEKT (W) 75/65/20°C	VOLUM (L)	EXPONENT N	GREUTATE (KG)
	1800	104	F092006018000300		547	947	1827	11.9	1.29	48.6
	2000	104	F092006020000300		608	1052	2030	13.2	1.29	53.9
	2600	104	F092006026000300		790	1368	2639	17.2	1.29	69.8
	3000	104	F092006030000300		912	1579	3045	19.8	1.29	8.5
Tip 30										
	400	154	F093006004000300		164	287	560	3.9	1.31	14.4
	500	154	F093006005000300		206	359	700	4.9	1.31	18.4
	600	154	F093006006000300		247	431	840	5.9	1.31	21.8
	700	154	F093006007000300		288	503	980	6.9	1.31	25.5
	800	154	F093006008000300		329	574	1120	7.8	1.31	29.2
	900	154	F093006009000300		370	646	1260	8.8	1.31	32.8
	1000	154	F093006010000300		411	718	1400	9.8	1.31	36.5
	1100	154	F093006011000300		452	790	1540	10.8	1.31	4.2
	1200	154	F093006012000300		493	862	1680	11.8	1.31	43.9
	1400	154	F093006014000300		575	1005	1960	13.7	1.31	51.3
	1600	154	F093006016000300		658	1149	2240	15.7	1.31	58.7
	1800	154	F093006018000300		740	1292	2520	17.6	1.31	66.8
	2000	154	F093006020000300		822	1436	2800	19.6	1.31	73.5
	2300	154	F093006023000300		945	1651	3220	22.5	1.31	84.5
	2600	154	F093006026000300		1069	1867	3640	25.5	1.31	95.6
	3000	154	F093006030000300		1233	2154	4200	29.4	1.31	114



900

ÎNĂLȚIME 900 mm	LUNGIME	ADÂNCIME	NR. ARTICOL (STÂNGA)	NR. ARTICOL (DREAPTA)	EFFEKT (W) 45/35/20°C	EFFEKT (W) 55/45/20°C	EFFEKT (W) 75/65/20°C	VOLUM (L)	EXPONENT N	GREUTATE (KG)
Tip 10										
400	49		F091009004001300	F091009004000300	99	171	328	1.8	1.28	11.5
500	49		F091009005001300	F091009005000300	124	214	410	2.3	1.28	14.4
600	49		F091009006001300	F091009006000300	149	256	492	2.7	1.28	16.7
700	49		F091009007001300	F091009007000300	173	299	574	3.1	1.28	19.2
800	49		F091009008001300	F091009008000300	198	342	656	3.6	1.28	21.9
900	49		F091009009001300	F091009009000300	223	384	738	4.0	1.28	24.4
1000	49		F091009010001300	F091009010000300	248	427	820	4.5	1.28	27.0
1100	49		F091009011001300	F091009011000300	272	470	902	5.0	1.28	29.5
1200	49		F091009012001300	F091009012000300	297	513	984	5.4	1.28	32.1
1400	49		F091009014001300	F091009014000300	347	598	1148	6.3	1.28	37.3
1600	49		F091009016001300	F091009016000300	396	683	1312	7.2	1.28	42.4
1800	49		F091009018001300	F091009018000300	446	769	1476	8.1	1.28	47.6
2000	49		F091009020001300	F091009020000300	495	854	1640	9.0	1.28	52.7
Tip 20										
400	104		F092009004000300		171	295	564	3.6	1.27	15.9
500	104		F092009005000300		214	368	706	4.5	1.27	19.8
700	104		F092009007000300		299	516	988	6.3	1.27	27.6
800	104		F092009008000300		342	589	1129	7.2	1.27	31.6
900	104		F092009009000300		385	663	1270	8.1	1.27	35.5
1000	104		F092009010000300		428	736	1411	9.0	1.27	39.4
1100	104		F092009011000300		471	810	1552	9.9	1.27	43.4
1200	104		F092009012000300		513	884	1693	10.8	1.27	47.3
1400	104		F092009014000300		599	1031	1975	12.6	1.27	55.1
1800	104		F092009018000300		770	1326	2540	16.2	1.27	78
2000	104		F092009020000300		856	1473	2822	18.0	1.27	78.7



900

ÎNĂLȚIME 900 mm	LUNGIME	ADÂNCIME	NR. ARTICOL (STÂNGA)	NR. ARTICOL (DREAPTA)	EFFEKT (W) 45/35/20°C	EFFEKT (W) 55/45/20°C	EFFEKT (W) 75/65/20°C	VOLUM (L)	EXPONENT N	GREUTATE (KG)
Tip 30										
	400	154	F093009004000300		225	394	771	5.3	1.32	19.7
	500	154	F093009005000300		281	492	964	6.7	1.32	25.1
	600	154	F093009006000300		337	591	1156	8.0	1.32	3.6
	700	154	F093009007000300		393	689	1349	9.3	1.32	36.5
	800	154	F093009008000300		449	787	1542	10.6	1.32	41.5
	900	154	F093009009000300		505	886	1734	12.0	1.32	46.9
	1100	154	F093009011000300		618	1083	2120	14.6	1.32	57.9
	1200	154	F093009012000300		674	1181	2312	16.0	1.32	63.3
	1600	154	F093009016000300		898	1575	3083	21.3	1.32	85.7
	1800	154	F093009018000300		1011	1772	3469	23.9	1.32	96.0
	2000	154	F093009020000300		1123	1968	3854	26.6	1.32	109.0