



Fișă tehnică
2026-05-02

Faro V

Accentuează înălțimea oricărui interior



- ✓ Design elegant și conturat
- ✓ Soluție ideală pentru spații limitate pe perete
- ✓ Conexiune centrală pentru radiator
- ✓ Poate fi rotat pentru conectare de sus
- ✓ Oțel inoxidabil de înaltă calitate

Stilul **Faro V** este accentuat de un front profilat vertical fin și panouri laterale rotunjite. Acest radiator decorativ nu doar creează o senzație de înălțime, ci este și o sursă puternică de căldură acolo unde suprafața peretelui este limitată. Culoarea standard este alb RAL 9016, cu alte culori speciale disponibile. Accesoriile includ un suport de prosoape din oțel inoxidabil, inclusiv set de șuruburi și dibluri cu instrucțiuni de montaj, capace laterale cu cleme de instalare, 3 dopuri oarbe din alamă și aerisire.



Domeniu de aplicare

Faro V este ideal pentru spații rezidențiale și comerciale unde spațiul pe perete este limitat. Este o sursă de căldură puternică cu plăci de oțel montate din fabrică, panouri laterale și grătar superior. Potrivit pentru sisteme de încălzire indirectă 2-conductă cu conexiuni 6 x 1/2" BSP.

Dimensionare

Folosiți un Calculator de Cerere de Căldură pentru a determina puterea termică necesară din gama Faro V.

Utilizare

Ventilul de aer și pachetele de dopuri sunt incluse în ambalaj. Robinetele termostactice pentru radiator pot fi instalate pentru a controla temperatura camerei. Radiatorul trebuie fixat în siguranță pe perete folosind suporturile, șuruburile și diblurile incluse. Pentru funcționalitate sporită, este disponibil un suport pentru prosoape din oțel inoxidabil.

Descriere

Radiatorul de design Faro V, conceput ca un radiator vertical cu o suprafață frontală fin profilată vertical și capace laterale ușor curbate, versiunea tip 21 cu două panouri de încălzire și un strat de aripioare de convecție sau ca tip 22 cu două panouri de încălzire și două straturi de aripioare de convecție.



Specificații

PROPRIETĂȚI	UNITATE	VALORI
ETIM Class		EC011022
Material		Oțel
Tip		20, 21, 22
Forma suprafeței		Plat neted
Presiune maximă de lucru	bar	10
Număr de conexiuni standard		4
Putere termică conform laboratorului recunoscut EN 442		Da
Temperatura maximă de operare	°C	110
Culoare standard		Da
Culoare		Alb
Cod RAL		9016
Grilă /protecție, laterală		Da
Grilă /protecție, superioară		Da
Valoarea luciului		Lucios
Dimensiunea filetului (țoli)		1/2 inch
Conexiune filetată		Filet interior
Cu conexiune într-un singur punct		Da
Cu racord pentru aerisire		Da
Cu ventil de aerisire		Da
Cu opțiuni de golire/ scurgere		Da



Documente

DOCUMENTE	TIPUL DOCUMENTULUI	LINK / ADRESA URL
Catalog tehnic - Radiatoare panou, decorative, de baie si ventiloconvectoare	Brochure	https://asset.productmarketingcloud.com/api/assetstorage/3577_aeba8a24-faa1-4941-ac96-483732f0a7cf
Manual de instalare Faro V	TechDia	https://asset.productmarketingcloud.com/api/assetstorage/3577_6a68539c-c460-4642-8d8b-056f68b79286



Resurse

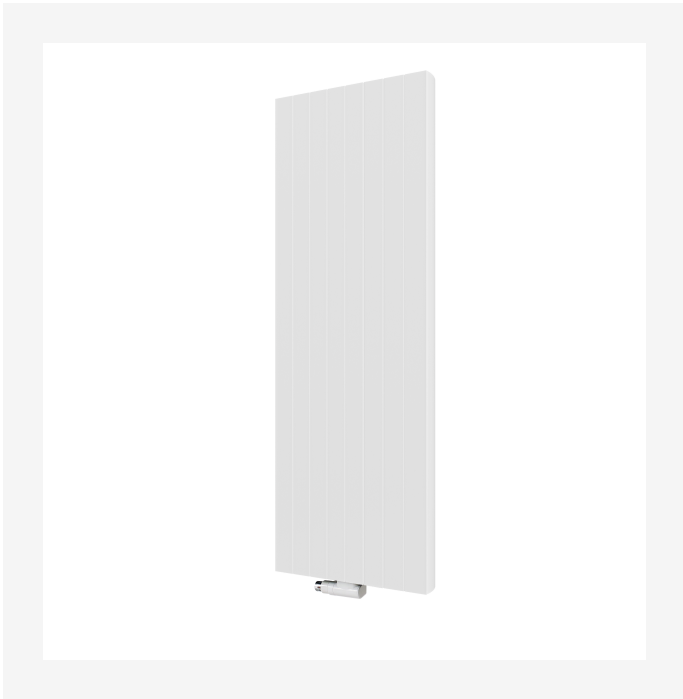

ProductImage - New Faro V main picture

ProductImage - Intersection image of vertical radiator Faro V, FAV.

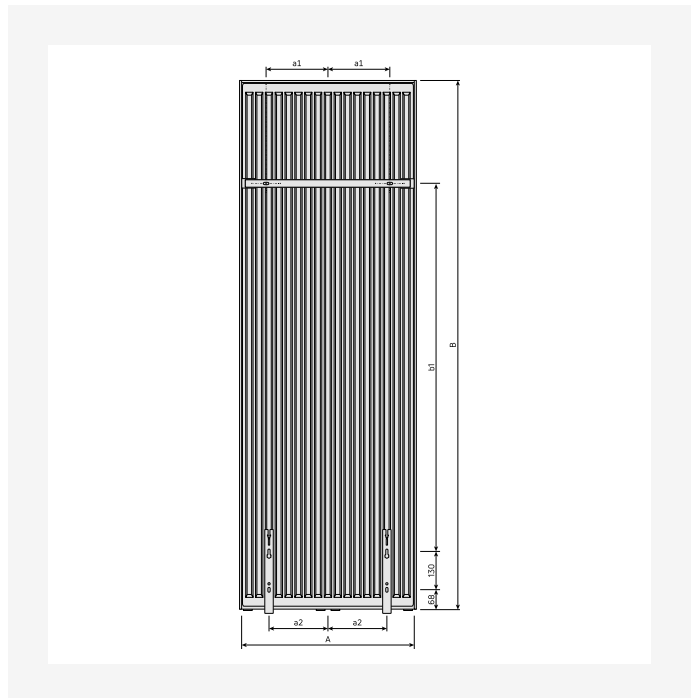
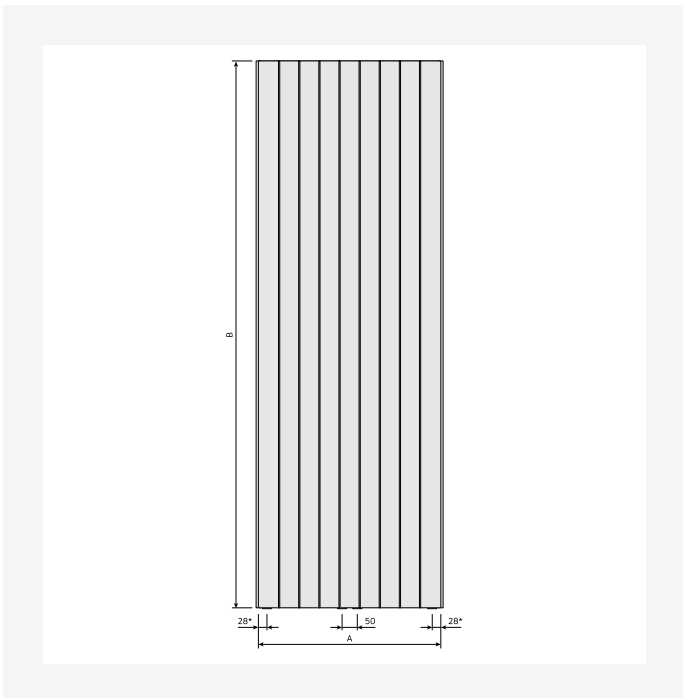

DimensionalDrawing - New_Faro V front view

DimensionalDrawing - New_Kos V-Faro V rear view



Resurse

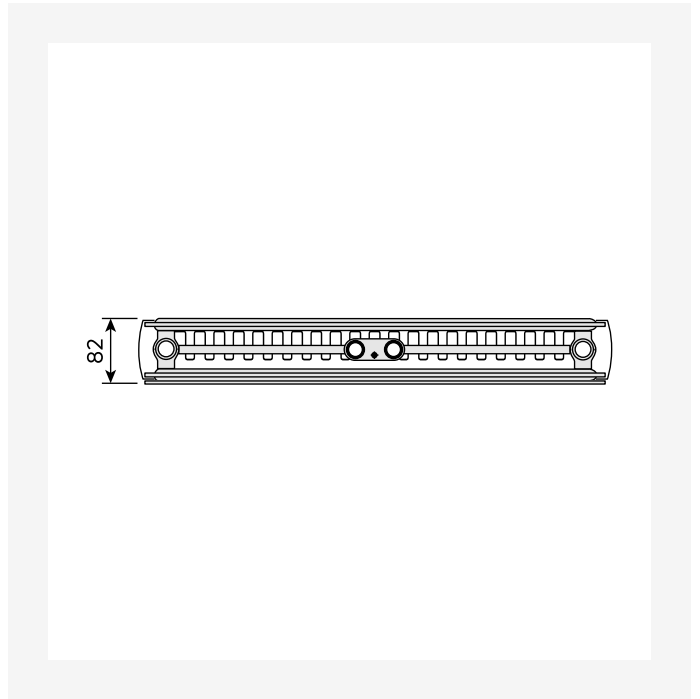
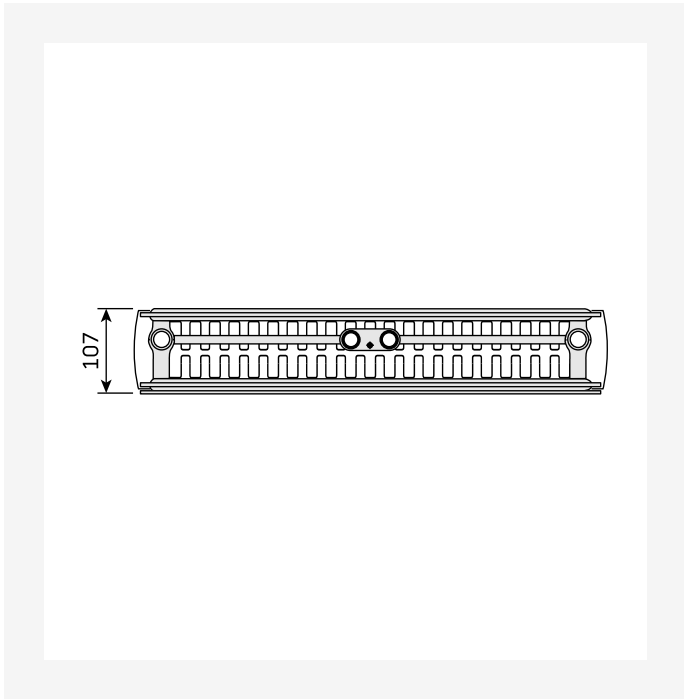

DimensionalDrawing - New_Kos V-Faro V top view

DimensionalDrawing - New_Kos V-Faro V top view

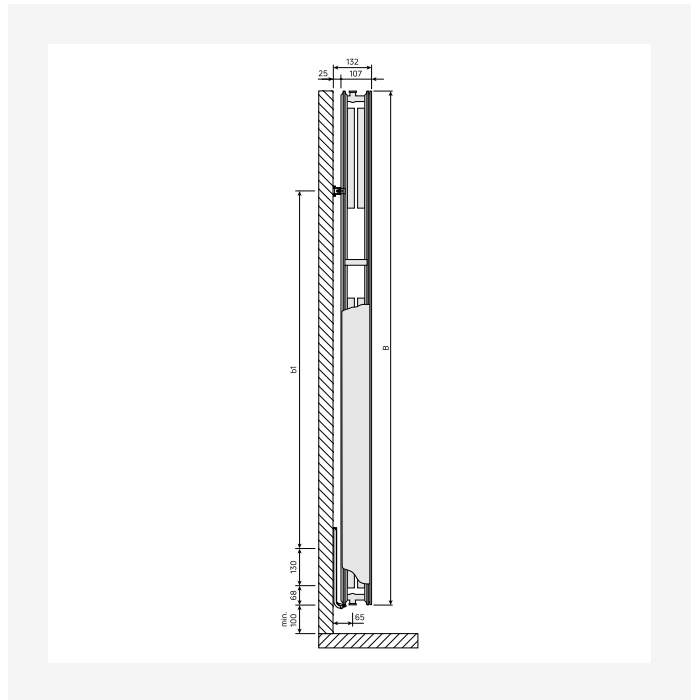
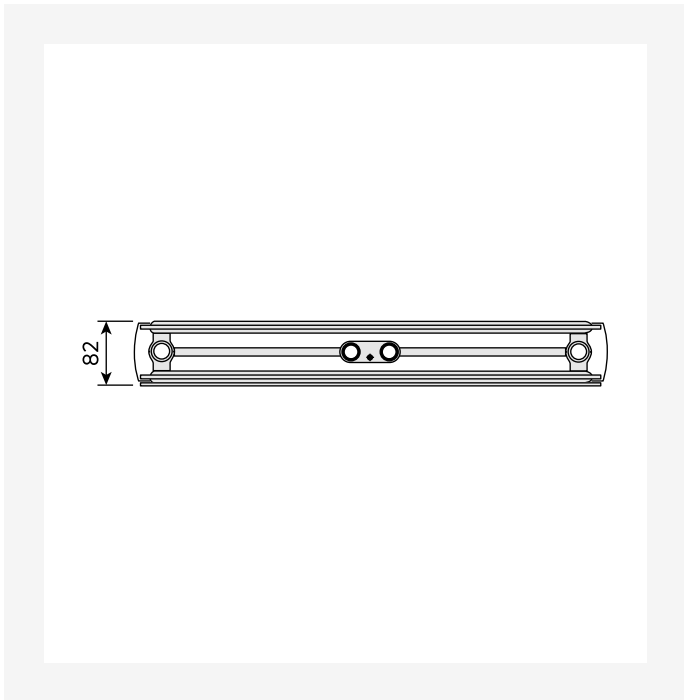

DimensionalDrawing - New_Kos V-Faro V top view

DimensionalDrawing - New_Kos V-Faro V side view



Resurse

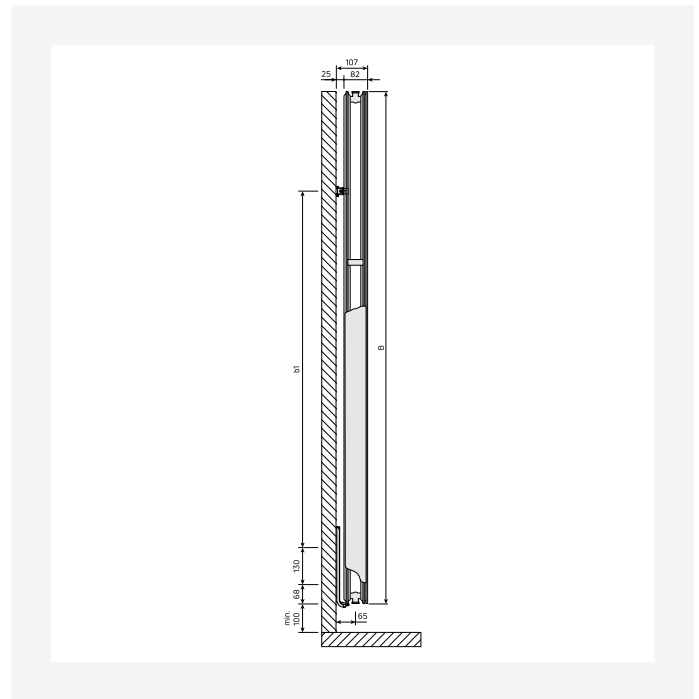
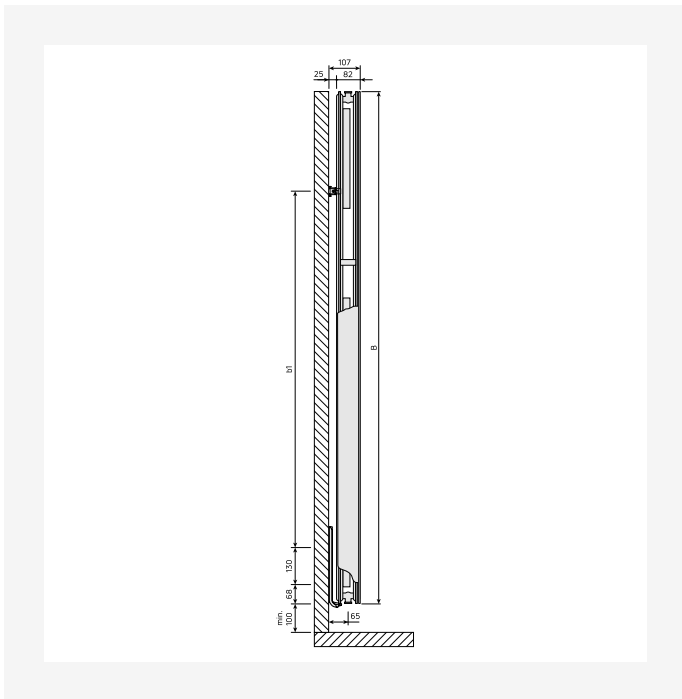

DimensionalDrawing - New_Kos V-Faro V side view

DimensionalDrawing - New_Kos V-Faro V side view

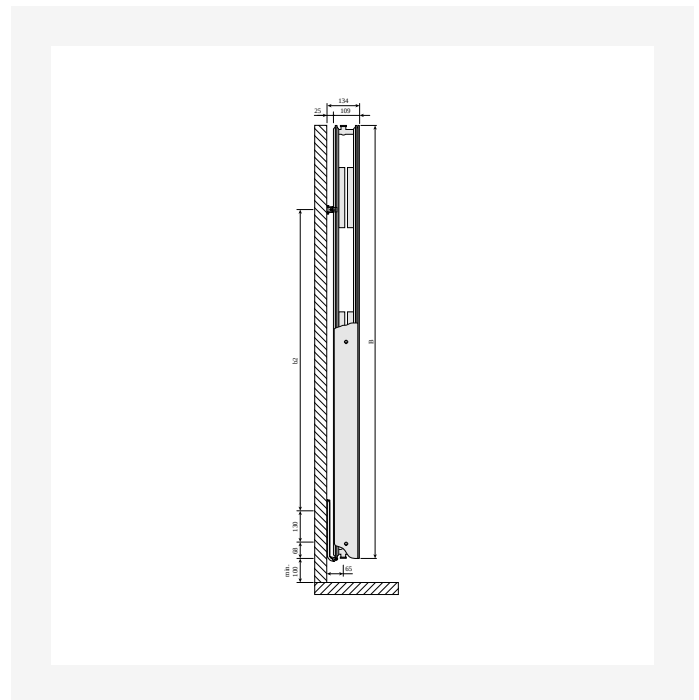
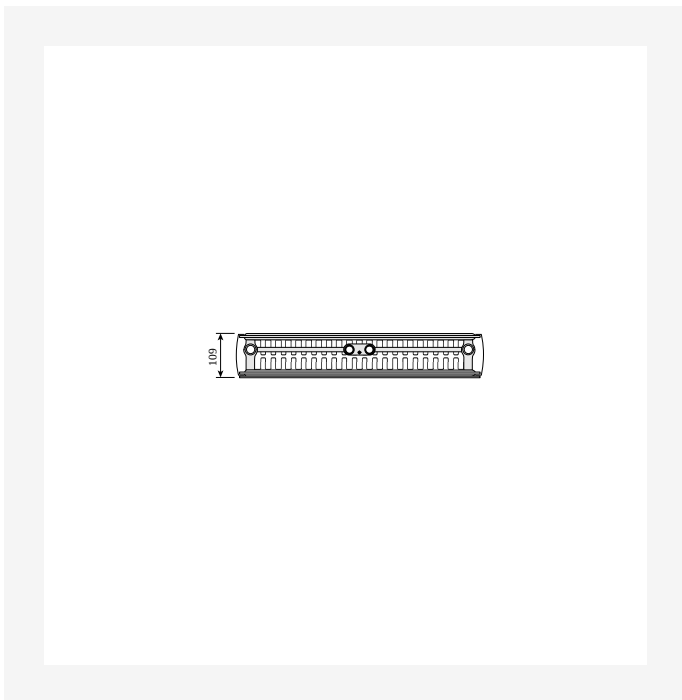

DimensionalDrawing - Kos V and Faro V, type 22, vedere de sus

DimensionalDrawing - Kos V and Faro V type 22, vedere laterala



Resurse

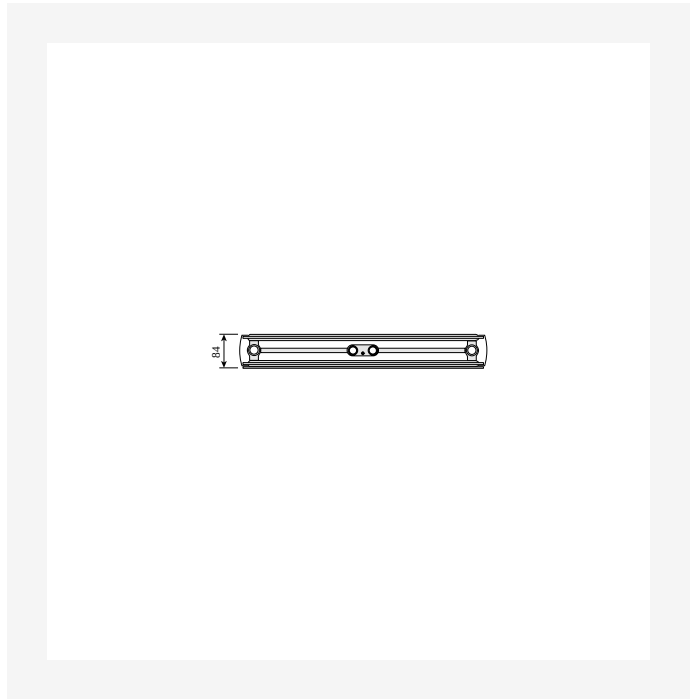
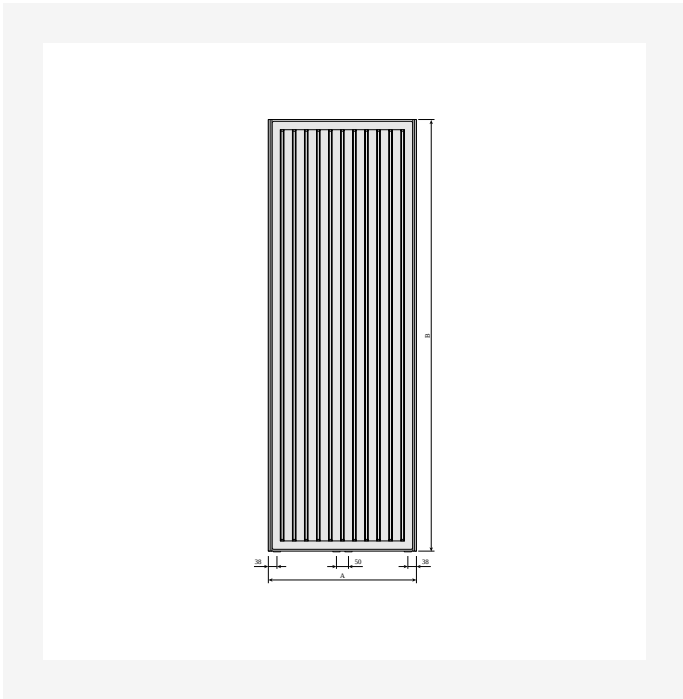

DimensionalDrawing - Kos V and Faro V vedere din spate

DimensionalDrawing - Kos V and Faro V type 20, vedere de sus

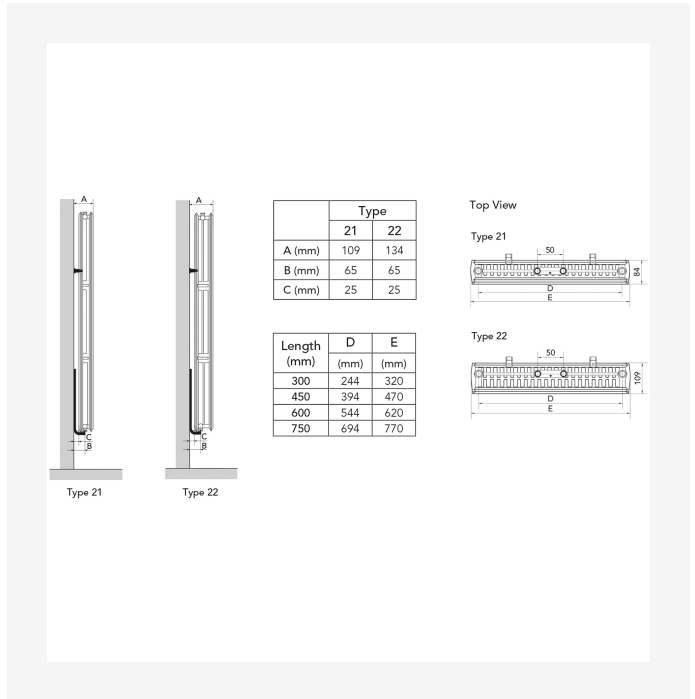
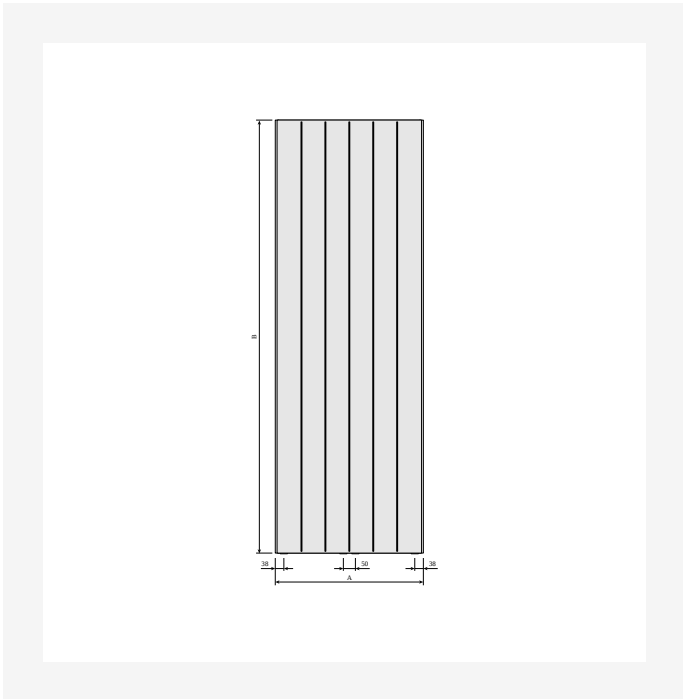

DimensionalDrawing - Faro V vedere din fata

DimensionalDrawing - Myson Plan & Plan Plus Vertical - Mounting Positions & Dimensions



Resurse

KOS V (mm)				
B	1500	1800	1950	2100
b1	1150	1450	1600	1750
b2	952	1252	1402	1552

KOS V (mm)				
A	320	470	620	770
a1	60	135	210	285
a2	75	125	200	250

DimensionalDrawing - Kos V, Faro V - table B

DimensionalDrawing - Kos V, Faro V - tabel A



Produse similare



Ramo Compact



Suport prosop pentru Vertical



Suport prosop Kos V / Faro V



Valvă cu cap termostatic, finisaj de design



Panou Lateral Kos V/Faro V



1500

ÎNĂLȚIME 1500 mm	LUNGIME	ADÂNCIME	NR. ARTICOL	EFFEKT (W) 45/35/20°C	EFFEKT (W) 55/45/20°C	EFFEKT (W) 75/65/20°C	VOLUM (L)	EXPONENT N	GREUTATE (KG)
Tip 21									
	300	82	FMW2115003011300	252	436	846	4.0	1.30	27.3
	450	82	FMW2115004511300	366	634	1230	6.1	1.30	39.2
	600	82	FMW2115006011300	476	826	1605	8.2	1.30	51.1
Tip 22									
	300	107	FMW2215003011300	300	521	1015	4.0	1.31	29.8
	450	107	FMW2215004511300	442	769	1502	6.2	1.31	43.1
	600	107	FMW2215006011300	581	1014	1983	8.3	1.31	56.5
	750	107	FMW2215007511300	--	1255	2460	10.3	1.32	69.8



1800

ÎNĂLȚIME 1800 mm	LUNGIME	ADÂNCIME	NR. ARTICOL	EFFEKT (W) 45/35/20°C	EFFEKT (W) 55/45/20°C	EFFEKT (W) 75/65/20°C	VOLUM (L)	EXPONENT N	GREUTATE (KG)
Tip 20									
	300	82	FMW2018003011300	267	459	881	4.8	1.28	30.1
	450	82	FMW2018004511300	382	657	1265	7.2	1.28	42.9
	600	82	FMW2018006011300	491	847	1635	9.7	1.29	55.6
Tip 21									
	300	82	FMW2118003011300	287	495	955	4.8	1.29	31.7
	450	82	FMW2118004511300	414	716	1389	7.2	1.30	45.8
	600	82	FMW2118006011300	535	930	1812	9.7	1.31	59.9
	750	82	FMW2118007511300	653	1139	2228	12.1	1.31	74.0
Tip 22									
	300	107	FMW2218003011300	342	592	1148	4.8	1.30	35.1
	450	107	FMW2218004511300	503	873	1698	7.3	1.30	50.6
	600	107	FMW2218006011300	660	1149	2242	9.7	1.31	66.1
	750	107	FMW2218007511300	815	1421	2781	12.2	1.31	81.5



1950

ÎNĂLȚIME 1950 mm	LUNGIME	ADÂNCIME	NR. ARTICOL	EFFEKT (W) 45/35/20°C	EFFEKT (W) 55/45/20°C	EFFEKT (W) 75/65/20°C	VOLUM (L)	EXPONENT N	GREUTATE (KG)
Tip 20									
	300	82	FMW2019503011300	288	495	949	5.2	1.28	32.5
	450	82	FMW2019504511300	412	709	1364	7.8	1.28	45.9
	600	82	FMW2019506011300	531	914	1763	10.4	1.29	59.3
	750	82	FMW2019507511300	645	1113	2152	13.0	1.29	72.8
Tip 21									
	300	82	FMW2119503011300	302	521	1008	5.2	1.29	34.1
	450	82	FMW2119504511300	437	756	1466	7.8	1.30	49.3
	600	82	FMW2119506011300	568	985	1913	10.4	1.30	64.4
	750	82	FMW2119507511300	694	1207	2351	13.0	1.31	79.6
Tip 22									
	300	107	FMW2219503011300	361	624	1208	5.3	1.29	37.3
	450	107	FMW2219504511300	532	922	1788	7.8	1.30	53.8
	600	107	FMW2219506011300	698	1213	2360	10.4	1.30	70.3
	750	107	FMW2219507511300	861	1500	2928	13.1	1.31	86.8



2100

ÎNĂLȚIME 2100 mm	LUNGIME	ADÂNCIME	NR. ARTICOL	EFFEKT (W) 45/35/20°C	EFFEKT (W) 55/45/20°C	EFFEKT (W) 75/65/20°C	VOLUM (L)	EXPONENT N	GREUTATE (KG)
Tip 20									
	300	82	FMW2021003011300	311	532	1016	5.6	1.27	34.8
	450	82	FMW2021004511300	443	761	1459	8.4	1.27	49.8
	600	82	FMW2021006011300	569	980	1886	11.1	1.28	64.8
	750	82	FMW2021007511300	690	1191	2302	13.9	1.29	79.8
Tip 21									
	300	82	FMW2121003011300	317	548	1060	5.6	1.29	36.5
	450	82	FMW2121004511300	460	796	1542	8.4	1.29	52.7
	600	82	FMW2121006011300	600	1038	2012	11.1	1.30	69.0
	750	82	FMW2121007511300	737	1276	2473	13.9	1.30	85.2
Tip 22									
	300	107	FMW2221003011300	380	655	1265	5.7	1.29	40.4
	450	107	FMW2221004511300	559	967	1872	8.4	1.29	58.0
	600	107	FMW2221006011300	734	1273	2471	11.2	1.30	75.6
	750	107	FMW2221007511300	906	1574	3066	13.9	1.30	93.2