



**Fișă tehnică**

2026-04-26

# Compact

Radiator de înaltă presiune pentru diverse utilizări în clădiri

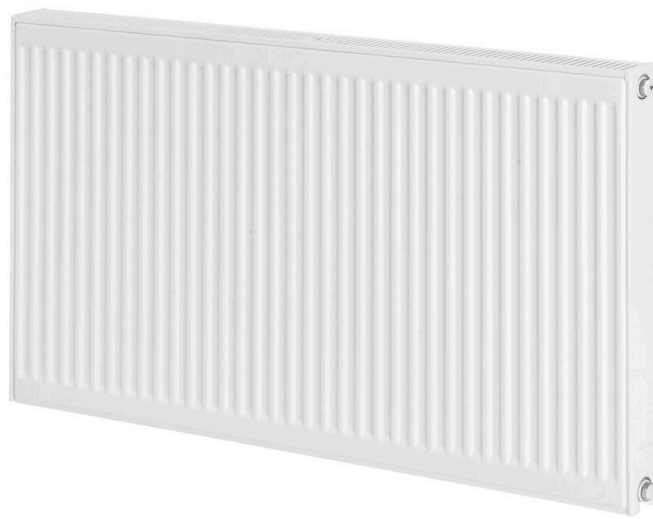

- ✓ **Rezistență ridicată la presiune**
- ✓ **Design estetic și atrăgător**
- ✓ **Instalare flexibilă**
- ✓ **Distribuție eficientă a căldurii**
- ✓ **Gama variată de culori disponibile**

Radiatoarele compact au o rezistență ridicată la presiune, fiind ideale pentru medii de încălzire dificile, cum ar fi instalațiile mari și clădirile conectate la încălzirea centralizată. Vin cu panouri laterale și grilaj superior pre-asamblate, garantând un finisaj estetic. Radiatorul este disponibil în alb RAL 9016, cu peste 70 de opțiuni de culoare la cerere. Distanțarea verticală a canalelor de apă de 33.3 mm asigură o distribuție eficientă a căldurii

**Domeniu de aplicare**

Potrivit pentru clădiri rezidențiale și comerciale care necesită setări de presiune ridicată de până la 10 bari. Ideal pentru clădiri cu mai multe etaje, sisteme de încălzire districtuală și instalații mai mari. Compatibil cu sisteme având temperaturi operaționale maxime de 110°C și prevăzut cu canale verticale de apă la distanța de 33.3 mm pentru distribuția eficientă a căldurii.

**Dimensionare**

Folosiți serviciul nostru de design pentru o selecție detaliată sau consultați broșura noastră pentru o

selecție rapidă.

**Utilizare**

Asigurați-vă că instalarea se face folosind suporturile de perete MCW-7 furnizate pentru stabilitate. Conexiunile radiatorului se fac prin 4 deschideri laterale G 1/2". Este necesară întreținerea regulată pentru a verifica performanța optimă. Parametrii operaționali maximi includ o presiune de lucru de 10 bari și o temperatură de funcționare de până la 110°C.



# Specificații

PROPRIETĂȚI	UNITATE	VALORI
ETIM Class		EC011022
Material		Oțel
Tip		11, 21, 22, 33
Forma suprafeței		Profilat
Presiune maximă de lucru	bar	10
Număr de conexiuni standard		4
Putere termică conform laboratorului recunoscut EN 442		Da
Temperatura maximă de operare	°C	110
Culoare standard		Da
Culoare		Alb
Cod RAL		9016
Grilă /protecție, laterală		Da
Grilă /protecție, superioară		Da
Valoarea luciului		Lucios
Dimensiunea filetului (țoli)		1/2 inch
Conexiune filetată		Filet interior
Cu conexiune într-un singur punct		Da
Cu racord pentru aerisire		Da
Cu ventil de aerisire		Da
Cu opțiuni de golire/ scurgere		Da



# Documente

DOCUMENTE	TIPUL DOCUMENTULUI	LINK / ADRESA URL
Catalog tehnic - Radiatoare panou, decorative, de baie si ventiloconvectoare	Brochure	<a href="https://asset.productmarketingcloud.com/api/assetstorage/3577_aeba8a24-faa1-4941-ac96-483732f0a7cf">https://asset.productmarketingcloud.com/api/assetstorage/3577_aeba8a24-faa1-4941-ac96-483732f0a7cf</a>
Instrucțiuni de instalare Purmo Compact	TechDia	<a href="https://asset.productmarketingcloud.com/api/assetstorage/3577_2da398bb-5820-4a58-af2d-62333aa4e65e">https://asset.productmarketingcloud.com/api/assetstorage/3577_2da398bb-5820-4a58-af2d-62333aa4e65e</a>



# Resurse



ProductImage - Purmo Compact, C, detail above.



ProductImage - Purmo Compact, C, product image 30 degrees.

COMPACT (mm)				
	C11		C21s, C22, C33	
A	a1	a2	a1	a2
400-1600	117	-	133	-
1800	117	917	133	900
2000	117	1017	133	1000
2300	117	1150	133	1167
2600	117	1317	133	1300
3000	117	1517	133	1500

DimensionalDrawing - Instrucțiuni de instalare

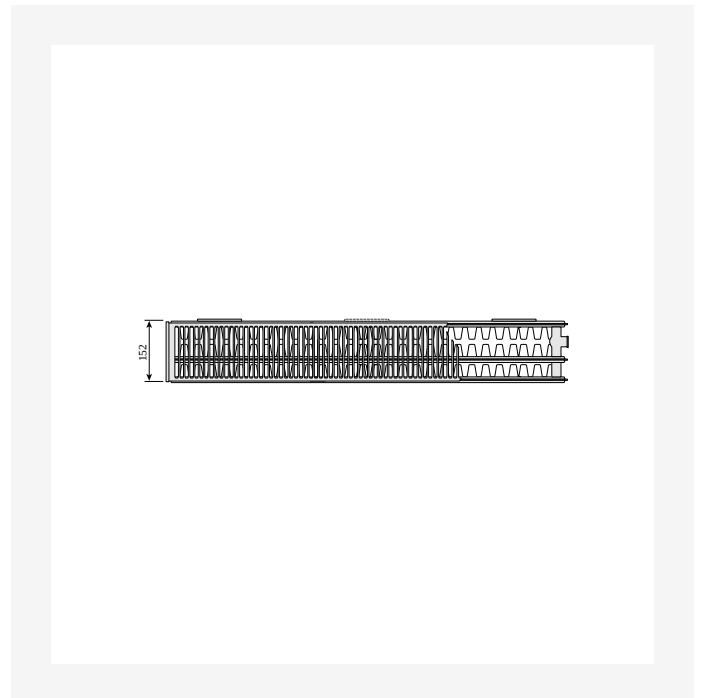

DimensionalDrawing - Tip 33



# Resurse

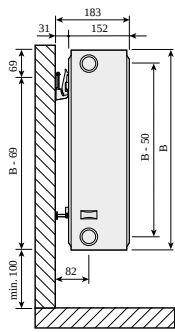

DimensionalDrawing - Compact type 33, side view with SSMS wall brackets

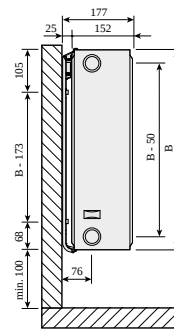

DimensionalDrawing - Compact, type 33, side view with Monclac wall brackets



DimensionalDrawing - Tip 22

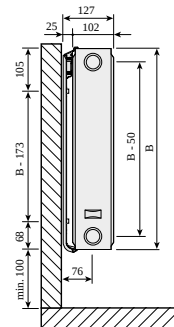

DimensionalDrawing - Compact, type 22, side view with Monclac wall brackets



# Resurse

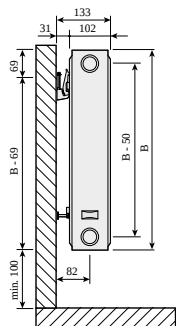

DimensionalDrawing - Compact tip 22, vedere laterală cu suporturi SSMS de perete

DimensionalDrawing - Tip 21s

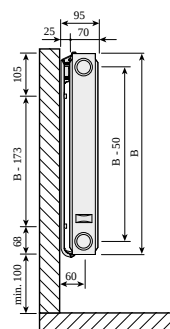
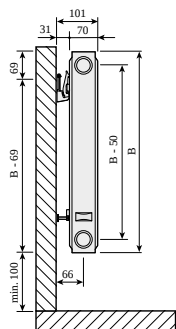

DimensionalDrawing - Compact tip 21, vedere laterală cu suporturi SSMS de perete

DimensionalDrawing - Compact, type 21, side view with Monclac wall brackets



# Resurse

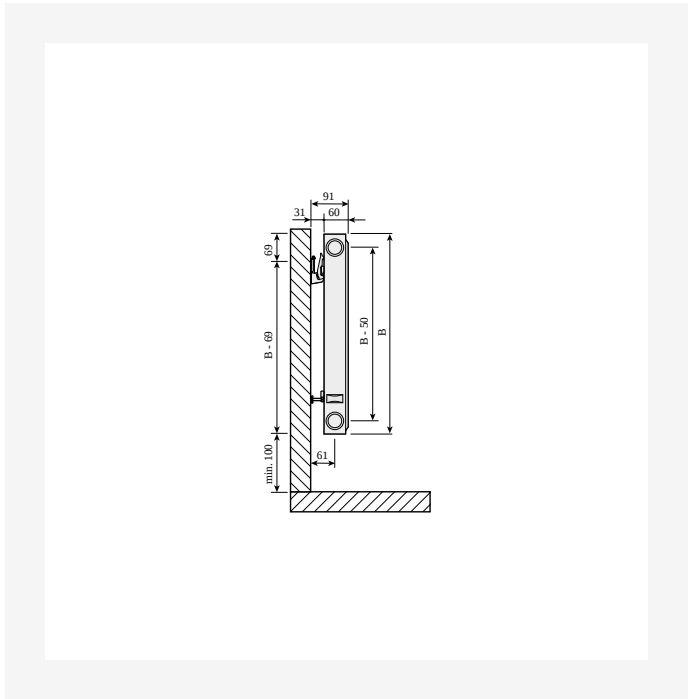
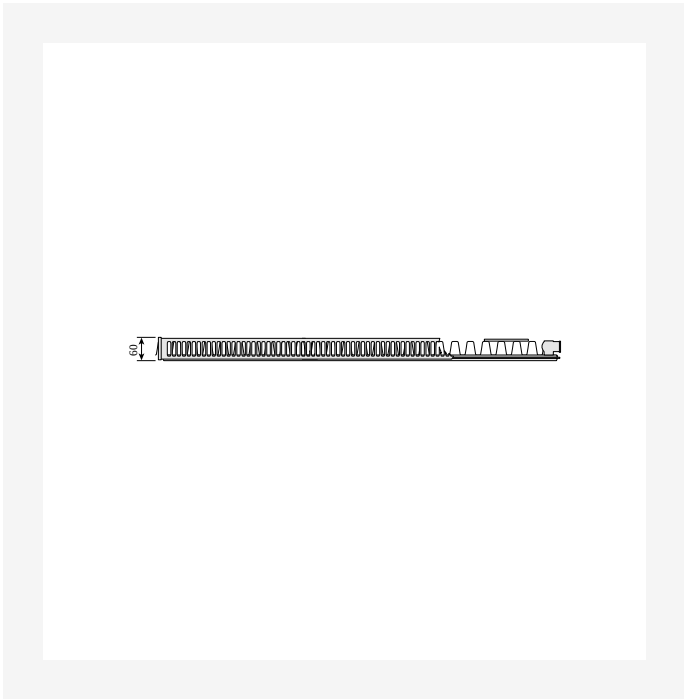

DimensionalDrawing - Tip 11

DimensionalDrawing - Compact tip 11, vedere laterală cu SSMS suporturi de perete

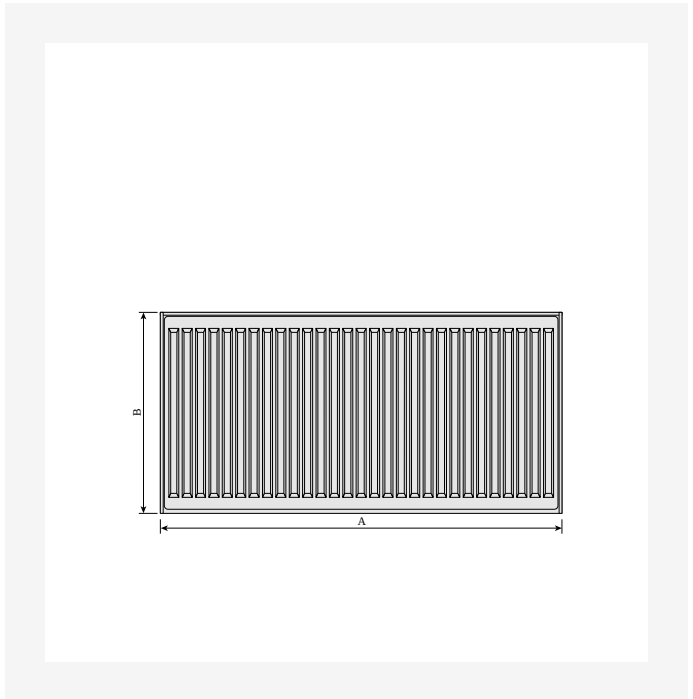
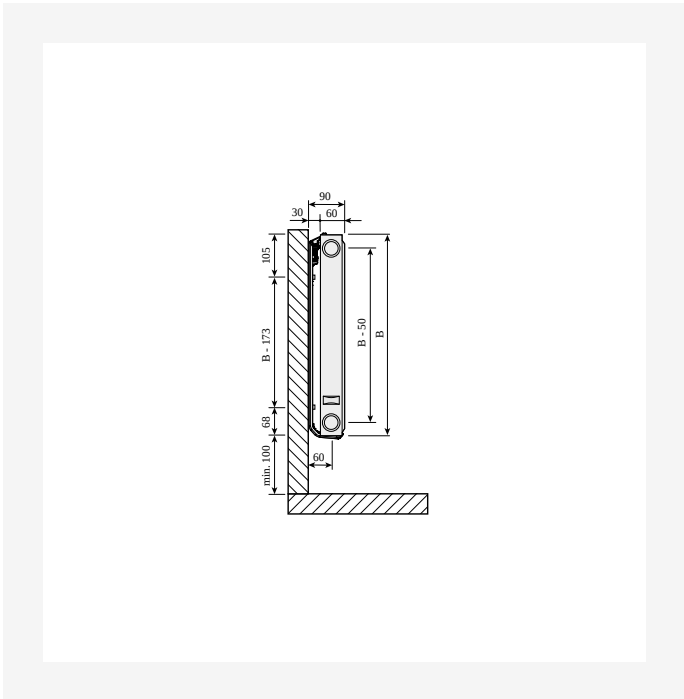

DimensionalDrawing - Compact, type 11, side view with Monclac wall brackets

DimensionalDrawing - Compact, vedere din fata



# Resurse

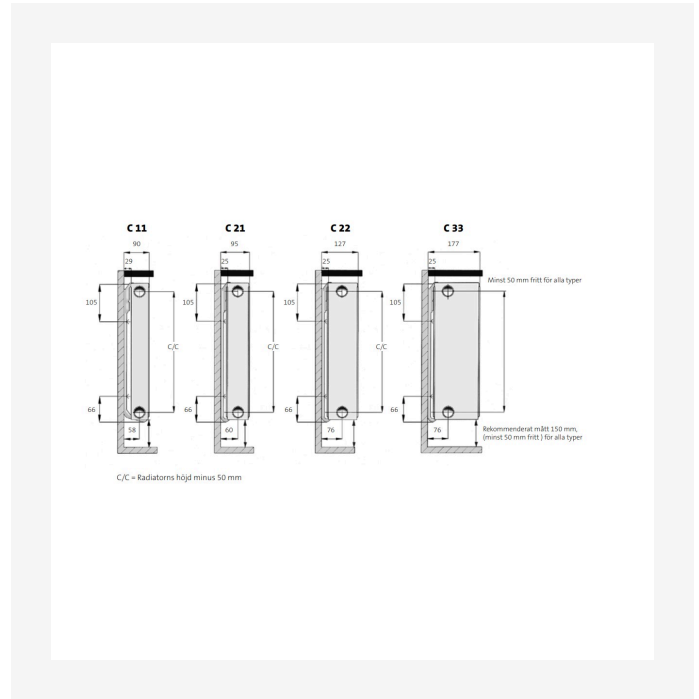
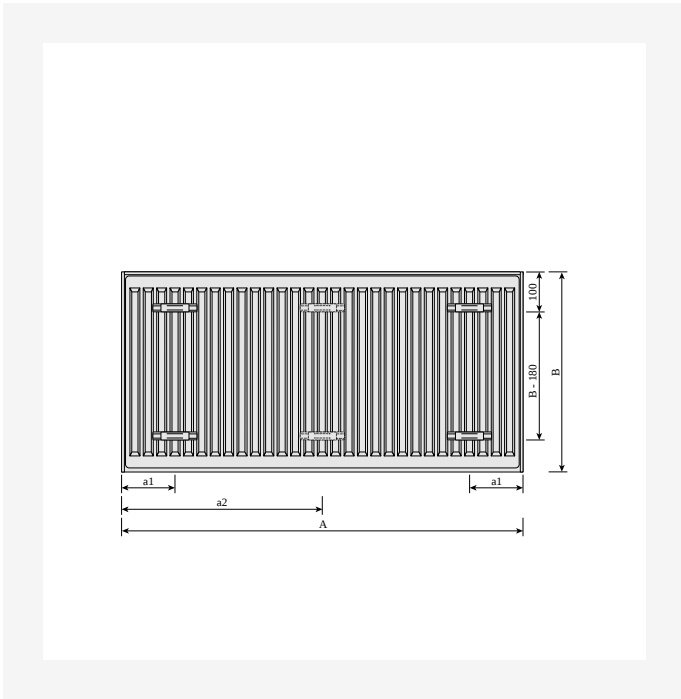

DimensionalDrawing - Compact, vedere din spate

DimensionalDrawing - Instalare

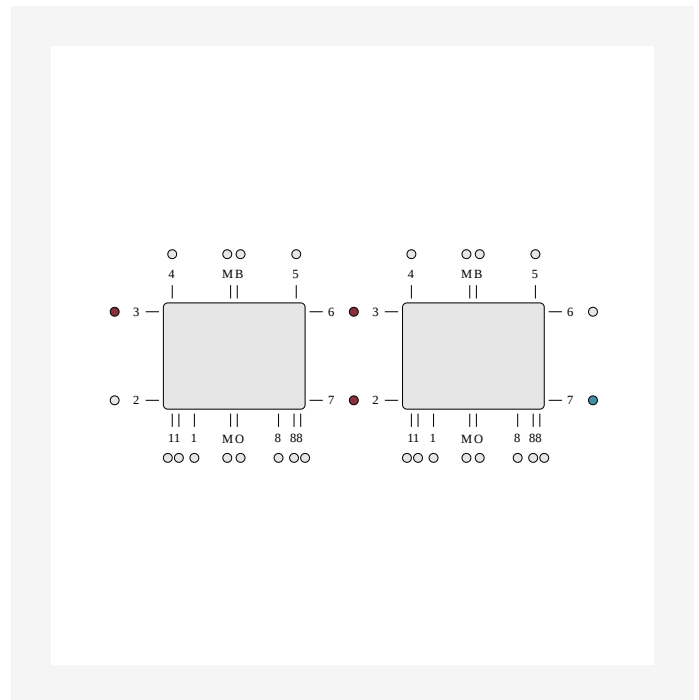
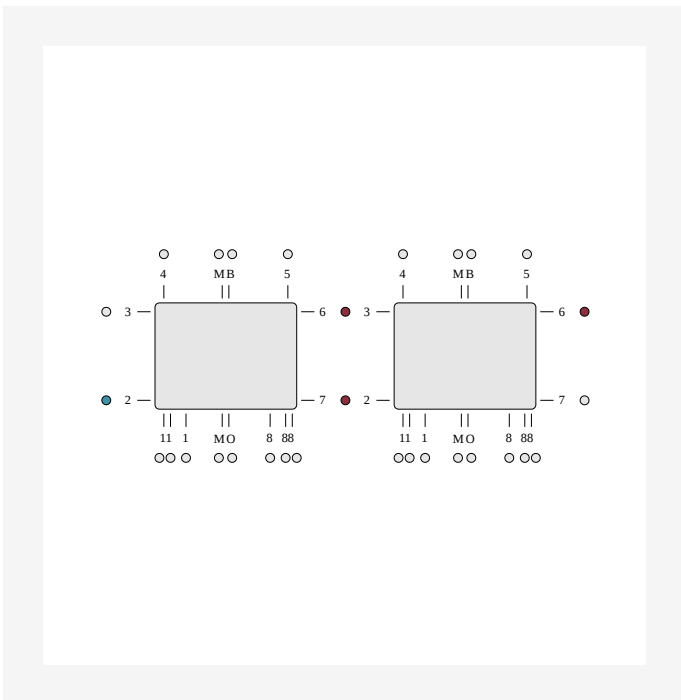

DimensionalDrawing - ETIM 62 Serial Horizontal connection

DimensionalDrawing - ETIM 37 Serial Horizontal connection



# Resurse

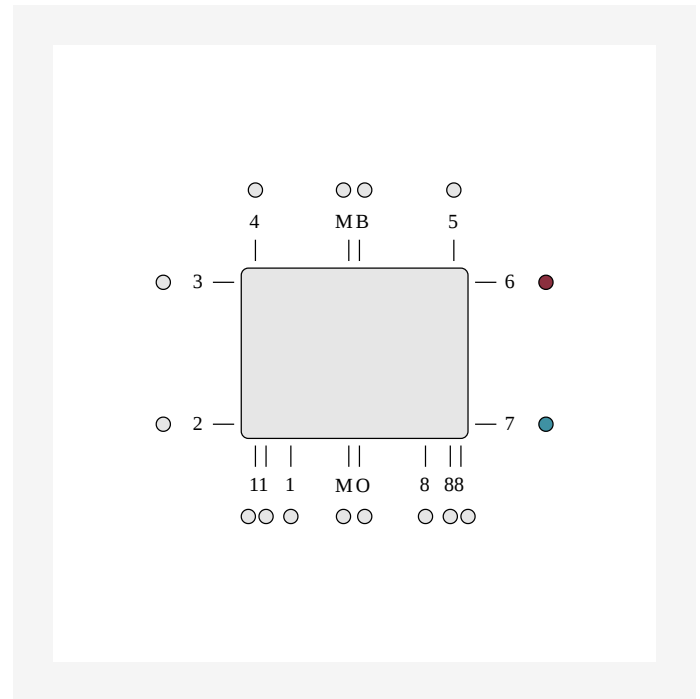
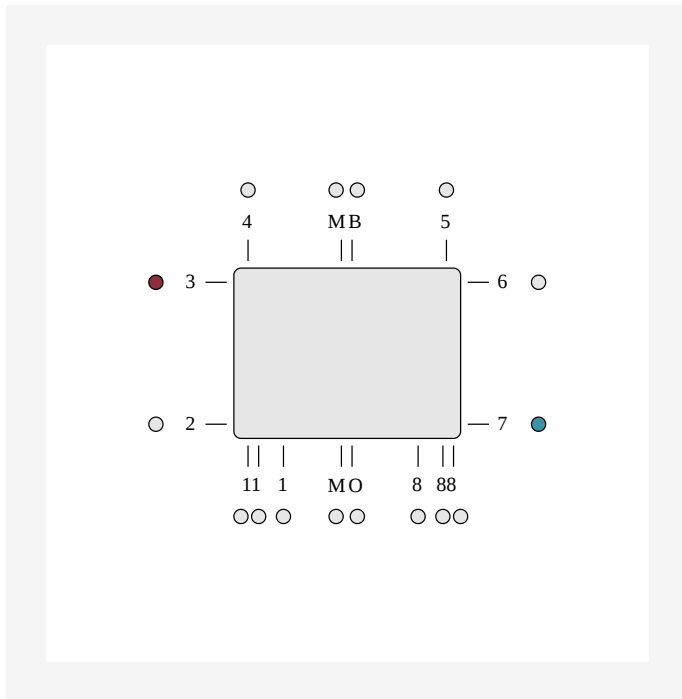

DimensionalDrawing - Diagonal connection ETIM 37. Diagonal connection requires the use of an external valve. In the case of a diagonal connection, the bottom connections are plugged.

DimensionalDrawing - Side connection ETIM 67. Side connection requires the use of an external radiator coupling or valve. In the case of side connection, the bottom connections are plugged.

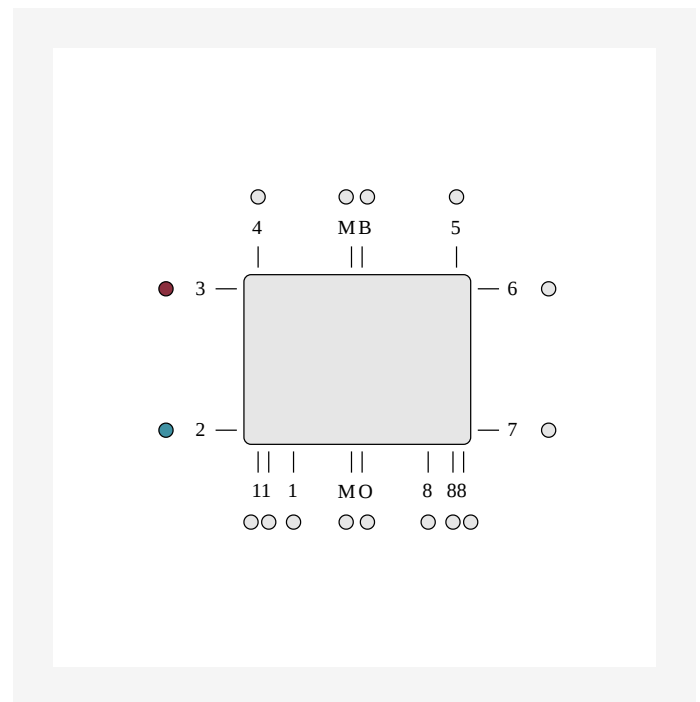
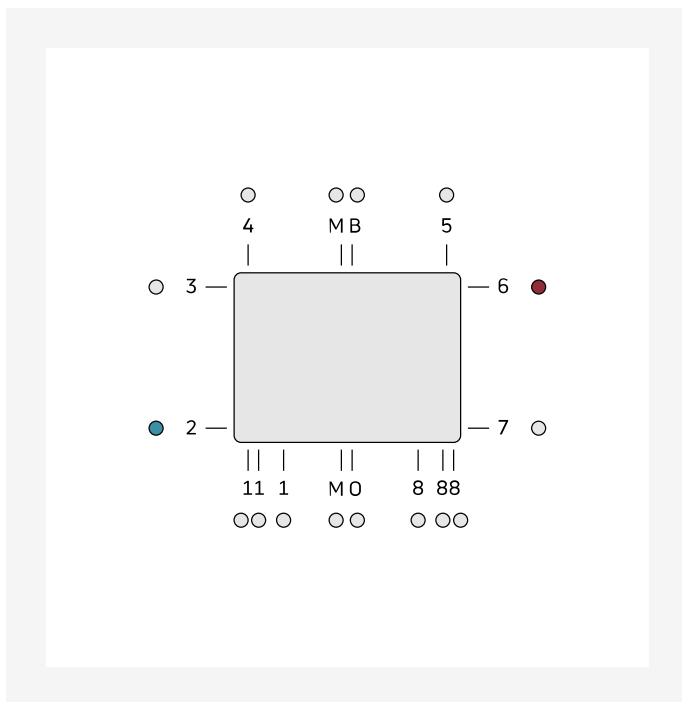

DimensionalDrawing - Diagonal connection ETIM 62. Diagonal connection requires the use of an external valve. In the case of a diagonal connection, the bottom connections are plugged.

DimensionalDrawing - Side connection ETIM 32. Side connection requires the use of an external radiator valve. In the case of side connection, the bottom connections are plugged.



# Produse similare





# 300

ÎNĂLȚIME 300 mm	LUNGIME	ADÂNCIME	NR. ARTICOL	EFFEKT (W) 45/35/20°C	EFFEKT (W) 55/45/20°C	EFFEKT (W) 75/65/20°C	VOLUM (L)	EXPONENT N	GREUTATE (KG)
<b>Tip 11</b>									
400	60		F061103004010300	65	113	218	0.7	1.30	4.4
500	60		F061103005010300	81	141	273	0.8	1.30	5.1
600	60		F061103006010300	97	169	328	1.0	1.30	5.9
700	60		F061103007010300	113	197	382	1.2	1.30	6.7
800	60		F061103008010300	129	225	437	1.4	1.30	7.5
900	60		F061103009010300	146	253	491	1.5	1.30	8.3
1000	60		F061103010010300	162	281	546	1.7	1.30	9.2
1100	60		F061103011010300	178	309	601	1.9	1.30	10.0
1200	60		F061103012010300	194	338	655	2.0	1.30	1.6
1400	60		F061103014010300	226	394	764	2.4	1.30	12.2
1800	60		F061103018010300	291	506	983	3.1	1.30	15.4
2000	60		F061103020010300	323	563	1092	3.4	1.30	17.0
2300	60		F061103023010300	372	647	1256	3.9	1.30	19.4
2600	60		F061103026010300	420	731	1420	4.4	1.30	21.7
3000	60		F061103030010300	485	844	1638	5.1	1.30	24.9
<b>Tip 21</b>									
400	70		F062103004010300	92	158	304	1.4	1.28	6.2
500	70		F062103005010300	115	198	381	1.7	1.28	7.4
600	70		F062103006010300	137	237	457	2.0	1.28	8.6
700	70		F062103007010300	160	277	533	2.4	1.28	10.0
800	70		F062103008010300	183	317	609	2.7	1.28	11.3
900	70		F062103009010300	206	356	685	3.1	1.28	12.3
1000	70		F062103010010300	229	396	761	3.4	1.28	13.6



# 300

ÎNĂLȚIME 300 mm	LUNGIME	ADÂNCIME	NR. ARTICOL	EFFEKT (W) 45/35/20°C	EFFEKT (W) 55/45/20°C	EFFEKT (W) 75/65/20°C	VOLUM (L)	EXPONENT N	GREUTATE (KG)
	1100	70	F062103011010300	252	435	837	3.7	1.28	14.8
	1400	70	F062103014010300	321	554	1065	4.8	1.28	18.7
	1600	70	F062103016010300	367	633	1218	5.4	1.28	21.1
	2000	70	F062103020010300	458	791	1522	6.8	1.28	26.1
	2300	70	F062103023010300	527	910	1750	7.8	1.28	30.0
	2600	70	F062103026010300	596	1029	1979	8.8	1.28	33.7
	3000	70	F062103030010300	687	1187	2283	10.2	1.28	38.7
<b>Tip 22</b>									
	400	102	F062203004010300	113	197	384	1.4	1.31	7.2
	500	102	F062203005010300	141	246	481	1.7	1.31	8.5
	600	102	F062203006010300	169	295	577	2.0	1.31	10.1
	700	102	F062203007010300	197	345	673	2.4	1.31	11.4
	800	102	F062203008010300	225	394	769	2.7	1.31	12.8
	900	102	F062203009010300	253	443	865	3.1	1.31	14.2
	1000	102	F062203010010300	282	492	961	3.4	1.31	15.6
	1100	102	F062203011010300	310	542	1057	3.7	1.31	17.4
	1200	102	F062203012010300	338	591	1153	4.1	1.31	18.5
	1400	102	F062203014010300	394	689	1345	4.8	1.31	21.3
	1600	102	F062203016010300	451	788	1538	5.4	1.31	24.2
	2000	102	F062203020010300	563	985	1922	6.8	1.31	29.9
	2300	102	F062203023010300	648	1132	2210	7.8	1.31	34.1
	2600	102	F062203026010300	732	1280	2499	8.8	1.31	38.5
	3000	102	F062203030010300	845	1477	2883	10.2	1.31	44.9
<b>Tip 33</b>									
	400	152	F063303004010300	157	275	539	2.0	1.31	1.3



# 300

ÎNĂLȚIME 300 mm	LUNGIME	ADÂNCIME	NR. ARTICOL	EFFEKT (W) 45/35/20°C	EFFEKT (W) 55/45/20°C	EFFEKT (W) 75/65/20°C	VOLUM (L)	EXPONENT N	GREUTATE (KG)
500	152		F063303005010300	196	344	674	2.5	1.31	12.4
600	152		F063303006010300	236	413	808	3.1	1.31	14.5
700	152		F063303007010300	275	482	943	3.6	1.31	16.7
800	152		F063303008010300	314	551	1078	4.1	1.31	18.8
900	152		F063303009010300	354	620	1212	4.6	1.31	2.9
1000	152		F063303010010300	393	688	1347	5.1	1.31	23.5
1100	152		F063303011010300	432	757	1482	5.6	1.31	25.2
1200	152		F063303012010300	472	826	1616	6.1	1.31	27.3
1400	152		F063303014010300	550	964	1886	7.1	1.31	31.6
1600	152		F063303016010300	629	1101	2155	8.2	1.31	35.8
1800	152		F063303018010300	707	1239	2425	9.2	1.31	4.7
2000	152		F063303020010300	786	1377	2694	10.2	1.31	44.3
2300	152		F063303023010300	904	1583	3098	11.7	1.31	5.7
3000	152		F063303030010300	1179	2065	4041	15.3	1.31	65.6



## 400

ÎNĂLȚIME 400 mm	LUNGIME	ADÂNCIME	NR. ARTICOL	EFFEKT (W) 45/35/20°C	EFFEKT (W) 55/45/20°C	EFFEKT (W) 75/65/20°C	VOLUM (L)	EXPONENT N	GREUTATE (KG)
<b>Tip 11</b>									
400	60		F061104004010300	84	146	284	0.9	1.30	5.5
500	60		F061104005010300	105	183	356	1.1	1.30	6.5
600	60		F061104006010300	126	219	427	1.3	1.30	7.6
800	60		F061104008010300	168	292	569	1.8	1.30	9.7
900	60		F061104009010300	189	329	640	2.0	1.30	1.8
1000	60		F061104010010300	210	366	711	2.2	1.30	11.8
1100	60		F061104011010300	231	402	782	2.4	1.30	12.9
1200	60		F061104012010300	252	439	853	2.6	1.30	14.0
1400	60		F061104014010300	294	512	995	3.1	1.30	16.1
1600	60		F061104016010300	335	585	1138	3.5	1.30	18.2
1800	60		F061104018010300	377	658	1280	4.0	1.30	2.4
2300	60		F061104023010300	482	841	1635	5.1	1.30	25.7
2600	60		F061104026010300	545	950	1849	5.7	1.30	28.9
3000	60		F061104030010300	629	1097	2133	6.6	1.30	33.2
<b>Tip 21</b>									
400	70		F062104004010300	115	199	385	1.8	1.29	7.7
500	70		F062104005010300	143	249	482	2.3	1.29	9.4
600	70		F062104006010300	172	298	578	2.7	1.29	11.1
700	70		F062104007010300	200	348	674	3.1	1.29	12.8
800	70		F062104008010300	229	398	770	3.6	1.29	14.5
900	70		F062104009010300	258	448	867	4.0	1.29	16.2
1000	70		F062104010010300	286	497	963	4.5	1.29	17.9
1100	70		F062104011010300	315	547	1059	5.0	1.29	19.6
1400	70		F062104014010300	401	696	1348	6.3	1.29	24.6



## 400

ÎNĂLȚIME 400 mm	LUNGIME	ADÂNCIME	NR. ARTICOL	EFFEKT (W) 45/35/20°C	EFFEKT (W) 55/45/20°C	EFFEKT (W) 75/65/20°C	VOLUM (L)	EXPONENT N	GREUTATE (KG)
	1600	70	F062104016010300	458	796	1541	7.2	1.29	28.3
	1800	70	F062104018010300	515	895	1733	8.1	1.29	31.4
	2000	70	F062104020010300	573	994	1926	9.0	1.29	34.8
	2600	70	F062104026010300	744	1293	2504	11.7	1.29	44.9
	3000	70	F062104030010300	859	1492	2889	13.5	1.29	51.7
<b>Tip 22</b>									
	400	102	F062204004010300	142	249	488	1.8	1.32	9.2
	500	102	F062204005010300	177	311	611	2.3	1.32	11.3
	600	102	F062204006010300	213	374	733	2.7	1.32	13.3
	700	102	F062204007010300	248	436	855	3.1	1.32	15.0
	800	102	F062204008010300	284	498	977	3.6	1.32	16.9
	900	102	F062204009010300	319	560	1099	4.0	1.32	18.8
	1000	102	F062204010010300	355	623	1221	4.5	1.32	2.7
	1100	102	F062204011010300	390	685	1343	5.0	1.32	22.6
	1200	102	F062204012010300	426	747	1465	5.4	1.32	24.6
	1600	102	F062204016010300	568	996	1954	7.2	1.32	32.3
	1800	102	F062204018010300	639	1121	2198	8.1	1.32	36.1
	2000	102	F062204020010300	710	1245	2442	9.0	1.32	40.0
	2300	102	F062204023010300	816	1432	2808	10.3	1.32	45.7
	2600	102	F062204026010300	923	1619	3175	11.7	1.32	51.6
	3000	102	F062204030010300	1064	1868	3663	13.5	1.32	59.2
<b>Tip 33</b>									
	500	152	F063304005010300	245	432	850	3.4	1.33	16.4
	600	152	F063304006010300	294	518	1019	4.0	1.33	19.2
	700	152	F063304007010300	343	604	1189	4.7	1.33	22.1



# 400

ÎNĂLȚIME 400 mm	LUNGIME	ADÂNCIME	NR. ARTICOL	EFFEKT (W) 45/35/20°C	EFFEKT (W) 55/45/20°C	EFFEKT (W) 75/65/20°C	VOLUM (L)	EXPONENT N	GREUTATE (KG)
800	152		F063304008010300	392	691	1359	5.4	1.33	25.0
900	152		F063304009010300	441	777	1529	6.0	1.33	27.9
1100	152		F063304011010300	539	950	1869	7.4	1.33	33.6
1200	152		F063304012010300	588	1036	2039	8.0	1.33	36.5
1400	152		F063304014010300	686	1209	2379	9.4	1.33	42.3
1600	152		F063304016010300	785	1381	2718	10.7	1.33	48.5
1800	152		F063304018010300	883	1554	3058	12.1	1.33	53.9
2000	152		F063304020010300	981	1726	3398	13.4	1.33	59.6
2300	152		F063304023010300	1128	1985	3908	15.4	1.33	68.2
2600	152		F063304026010300	1275	2244	4417	17.4	1.33	76.9
3000	152		F063304030010300	1471	2590	5097	20.1	1.33	88.4



## 450

ÎNĂLȚIME 450 mm	LUNGIME	ADÂNCIME	NR. ARTICOL	EFFEKT (W) 45/35/20°C	EFFEKT (W) 55/45/20°C	EFFEKT (W) 75/65/20°C	VOLUM (L)	EXPONENT N	GREUTATE (KG)
<b>Tip 11</b>									
	400	60	F061104504010300	93	162	316	1.0	1.30	6.4
	500	60	F061104505010300	116	203	395	1.3	1.30	7.6
	700	60	F061104507010300	163	284	553	1.8	1.30	1.2
	800	60	F061104508010300	186	325	632	2.0	1.30	11.4
	1000	60	F061104510010300	232	406	790	2.5	1.30	14.0
	1100	60	F061104511010300	256	446	869	2.8	1.30	15.2
	1400	60	F061104514010300	325	568	1106	3.5	1.30	19.4
	1600	60	F061104516010300	372	649	1264	4.0	1.30	21.5
	1800	60	F061104518010300	418	730	1422	4.5	1.30	24.5
	2000	60	F061104520010300	465	811	1580	5.0	1.30	26.6
	2300	60	F061104523010300	535	933	1817	5.8	1.30	3.4
<b>Tip 21</b>									
	400	70	F062104504010300	125	218	424	2.0	1.30	9.3
	500	70	F062104505010300	157	273	530	2.5	1.30	11.3
	600	70	F062104506010300	188	327	636	3.0	1.30	13.4
	700	70	F062104507010300	219	382	742	3.5	1.30	15.4
	800	70	F062104508010300	250	436	848	4.0	1.30	17.4
	900	70	F062104509010300	282	491	954	4.5	1.30	19.4
	1000	70	F062104510010300	313	545	1060	5.0	1.30	21.4
	1100	70	F062104511010300	344	600	1166	5.5	1.30	23.5
	1200	70	F062104512010300	376	654	1272	6.0	1.30	25.5
	1400	70	F062104514010300	438	764	1484	7.0	1.30	29.5
	1600	70	F062104516010300	501	873	1696	8.0	1.30	33.6
	1800	70	F062104518010300	564	982	1908	9.0	1.30	37.7



## 450

ÎNĂLȚIME 450 mm	LUNGIME	ADÂNCIME	NR. ARTICOL	EFFEKT (W) 45/35/20°C	EFFEKT (W) 55/45/20°C	EFFEKT (W) 75/65/20°C	VOLUM (L)	EXPONENT N	GREUTATE (KG)
	2000	70	F062104520010300	626	1091	2120	10.0	1.30	41.6
	2300	70	F062104523010300	720	1254	2438	11.5	1.30	47.7
	2600	70	F062104526010300	814	1418	2756	13.0	1.30	53.8
<b>Tip 22</b>									
	400	102	F062204504010300	156	274	539	2.0	1.32	1.6
	500	102	F062204505010300	195	343	674	2.5	1.32	13.0
	600	102	F062204506010300	234	411	808	3.0	1.32	15.3
	700	102	F062204507010300	273	480	943	3.5	1.32	17.6
	800	102	F062204508010300	312	548	1078	4.0	1.32	19.9
	900	102	F062204509010300	351	617	1212	4.5	1.32	22.2
	1000	102	F062204510010300	390	685	1347	5.0	1.32	24.5
	1100	102	F062204511010300	429	754	1482	5.5	1.32	26.8
	1200	102	F062204512010300	468	822	1616	6.0	1.32	29.1
	1400	102	F062204514010300	546	960	1886	7.0	1.32	33.7
	1600	102	F062204516010300	624	1097	2155	8.0	1.32	38.3
	2000	102	F062204520010300	780	1371	2694	10.0	1.32	47.6
	2300	102	F062204523010300	897	1576	3098	11.5	1.32	54.5
	2600	102	F062204526010300	1014	1782	3502	13.0	1.32	61.4
	3000	102	F062204530010300	1169	2056	4041	15.0	1.32	7.6
<b>Tip 33</b>									
	400	152	F063304504010300	215	379	748	3.0	1.33	15.8
	500	152	F063304505010300	268	473	935	3.8	1.33	19.2
	600	152	F063304506010300	322	568	1121	4.5	1.33	22.7
	700	152	F063304507010300	376	663	1308	5.3	1.33	26.1
	900	152	F063304509010300	483	852	1682	6.8	1.33	33.7



# 450

ÎNĂLȚIME 450 mm	LUNGIME	ADÂNCIME	NR. ARTICOL	EFFEKT (W) 45/35/20°C	EFFEKT (W) 55/45/20°C	EFFEKT (W) 75/65/20°C	VOLUM (L)	EXPONENT N	GREUTATE (KG)
1000	152	152	F063304510010300	536	947	1869	7.5	1.33	36.5
1100	152	152	F063304511010300	590	1041	2056	8.3	1.33	39.9
1200	152	152	F063304512010300	644	1136	2243	9.0	1.33	43.3
1600	152	152	F063304516010300	858	1515	2990	12.0	1.33	57.1
1800	152	152	F063304518010300	966	1704	3364	13.5	1.33	64.1
2000	152	152	F063304520010300	1073	1894	3738	15.0	1.33	7.9
2300	152	152	F063304523010300	1234	2178	4299	17.3	1.33	81.2
2600	152	152	F063304526010300	1395	2462	4859	19.5	1.33	91.6
3000	152	152	F063304530010300	1609	2840	5607	22.5	1.33	107.4



## 500

ÎNĂLȚIME 500 mm	LUNGIME	ADÂNCIME	NR. ARTICOL	EFFEKT (W) 45/35/20°C	EFFEKT (W) 55/45/20°C	EFFEKT (W) 75/65/20°C	VOLUM (L)	EXPONENT N	GREUTATE (KG)
<b>Tip 11</b>									
	400	60	F061105004010300	102	178	347	1.1	1.31	6.5
	500	60	F061105005010300	127	223	434	1.4	1.31	7.8
	600	60	F061105006010300	153	267	521	1.6	1.31	9.2
	700	60	F061105007010300	178	312	608	1.9	1.31	1.6
	800	60	F061105008010300	204	356	694	2.2	1.31	12.0
	900	60	F061105009010300	229	401	781	2.4	1.31	13.3
	1000	60	F061105010010300	255	445	868	2.7	1.31	14.8
	1100	60	F061105011010300	280	490	955	3.0	1.31	16.4
	1200	60	F061105012010300	306	534	1042	3.2	1.31	17.5
	1400	60	F061105014010300	357	623	1215	3.8	1.31	2.2
	1600	60	F061105016010300	408	712	1389	4.3	1.31	22.9
	1800	60	F061105018010300	459	801	1562	4.9	1.31	25.7
	2000	60	F061105020010300	510	890	1736	5.4	1.31	28.4
	2300	60	F061105023010300	586	1024	1996	6.2	1.31	32.6
	2600	60	F061105026010300	663	1158	2257	7.0	1.31	36.7
	3000	60	F061105030010300	765	1336	2604	8.1	1.31	43.0
<b>Tip 21</b>									
	500	70	F062105005010300	170	296	578	2.8	1.31	11.7
	600	70	F062105006010300	204	356	694	3.3	1.31	13.8
	800	70	F062105008010300	271	474	925	4.4	1.31	18.1
	900	70	F062105009010300	305	533	1040	5.0	1.31	2.1
	1000	70	F062105010010300	339	593	1156	5.5	1.31	22.2
	1100	70	F062105011010300	373	652	1272	6.0	1.31	24.3
	1200	70	F062105012010300	407	711	1387	6.6	1.31	26.4



## 500

ÎNĂLȚIME 500 mm	LUNGIME	ADÂNCIME	NR. ARTICOL	EFFEKT (W) 45/35/20°C	EFFEKT (W) 55/45/20°C	EFFEKT (W) 75/65/20°C	VOLUM (L)	EXPONENT N	GREUTATE (KG)
	1400	70	F062105014010300	475	830	1618	7.7	1.31	3.5
	1600	70	F062105016010300	543	948	1850	8.8	1.31	34.7
	1800	70	F062105018010300	611	1067	2081	9.9	1.31	38.9
	2000	70	F062105020010300	679	1185	2312	11.0	1.31	43.9
	2600	70	F062105026010300	882	1541	3006	14.3	1.31	55.6
	3000	70	F062105030010300	1018	1778	3468	16.5	1.31	64.0
<b>Tip 22</b>									
	400	102	F062205004010300	169	299	588	2.2	1.33	11.2
	500	102	F062205005010300	212	373	735	2.8	1.33	13.7
	600	102	F062205006010300	254	448	882	3.3	1.33	16.4
	700	102	F062205007010300	297	522	1029	3.9	1.33	18.6
	800	102	F062205008010300	339	597	1176	4.4	1.33	2.9
	900	102	F062205009010300	381	672	1323	5.0	1.33	23.4
	1000	102	F062205010010300	424	746	1470	5.5	1.33	25.8
	1100	102	F062205011010300	466	821	1617	6.0	1.33	28.3
	1200	102	F062205012010300	508	896	1764	6.6	1.33	3.6
	1400	102	F062205014010300	593	1045	2058	7.7	1.33	35.5
	1600	102	F062205016010300	678	1194	2352	8.8	1.33	4.3
	1800	102	F062205018010300	763	1343	2646	9.9	1.33	45.2
	2000	102	F062205020010300	847	1493	2940	11.0	1.33	51
	2300	102	F062205023010300	974	1717	3381	12.7	1.33	57.3
	2600	102	F062205026010300	1102	1940	3822	14.3	1.33	64.6
<b>Tip 33</b>									
	400	152	F063305004010300	232	411	814	3.3	1.34	16.6
	600	152	F063305006010300	349	617	1221	4.9	1.34	23.9



# 500

ÎNĂLȚIME 500 mm	LUNGIME	ADÂNCIME	NR. ARTICOL	EFFEKT (W) 45/35/20°C	EFFEKT (W) 55/45/20°C	EFFEKT (W) 75/65/20°C	VOLUM (L)	EXPONENT N	GREUTATE (KG)
700	152		F063305007010300	407	719	1425	5.7	1.34	27.6
800	152		F063305008010300	465	822	1628	6.6	1.34	31.1
900	152		F063305009010300	523	925	1832	7.4	1.34	34.8
1000	152		F063305010010300	581	1028	2035	8.2	1.34	38.5
1100	152		F063305011010300	639	1131	2239	9.0	1.34	42.4
1200	152		F063305012010300	697	1233	2442	9.8	1.34	45.7
1400	152		F063305014010300	813	1439	2849	11.5	1.34	52.9
1600	152		F063305016010300	930	1645	3256	13.1	1.34	6.2
1800	152		F063305018010300	1046	1850	3663	14.8	1.34	67.5
2000	152		F063305020010300	1162	2056	4070	16.4	1.34	74.7
2300	152		F063305023010300	1336	2364	4681	18.9	1.34	85.6
2600	152		F063305026010300	1511	2672	5291	21.3	1.34	96.6
3000	152		F063305030010300	1743	3084	6105	24.6	1.34	111.9



## 550

ÎNĂLȚIME 550 mm	LUNGIME	ADÂNCIME	NR. ARTICOL	EFFEKT (W) 45/35/20°C	EFFEKT (W) 55/45/20°C	EFFEKT (W) 75/65/20°C	VOLUM (L)	EXPONENT N	GREUTATE (KG)
<b>Tip 11</b>									
	400	60	F061105504010300	111	193	378	1.2	1.31	7.3
	500	60	F061105505010300	138	242	472	1.5	1.31	8.8
	600	60	F061105506010300	166	290	566	1.8	1.31	1.2
	700	60	F061105507010300	194	339	661	2.1	1.31	11.8
	800	60	F061105508010300	221	387	755	2.4	1.31	13.2
	900	60	F061105509010300	249	435	850	2.7	1.31	14.7
	1000	60	F061105510010300	277	484	944	3.0	1.31	16.1
	1100	60	F061105511010300	304	532	1038	3.3	1.31	17.6
	1200	60	F061105512010300	332	580	1133	3.6	1.31	19.1
	1400	60	F061105514010300	387	677	1322	4.2	1.31	22.5
	1600	60	F061105516010300	443	774	1510	4.8	1.31	25.5
	2000	60	F061105520010300	553	967	1888	6.0	1.31	3.9
	2300	60	F061105523010300	636	1112	2171	6.9	1.31	35.3
	3000	60	F061105530010300	830	1451	2832	9.0	1.31	45.7
<b>Tip 21</b>									
	500	70	F062105505010300	182	319	625	3.0	1.31	12.8
	600	70	F062105506010300	219	383	749	3.7	1.31	15.3
	700	70	F062105507010300	255	447	874	4.3	1.31	17.7
	800	70	F062105508010300	291	511	999	4.9	1.31	2.2
	900	70	F062105509010300	328	574	1124	5.5	1.31	22.6
	1000	70	F062105510010300	364	638	1249	6.1	1.31	25.6
	1100	70	F062105511010300	401	702	1374	6.7	1.31	27.5
	1200	70	F062105512010300	437	766	1499	7.3	1.31	30.0
	1400	70	F062105514010300	510	893	1749	8.5	1.31	34.9



## 550

ÎNĂLȚIME 550 mm	LUNGIME	ADÂNCIME	NR. ARTICOL	EFFEKT (W) 45/35/20°C	EFFEKT (W) 55/45/20°C	EFFEKT (W) 75/65/20°C	VOLUM (L)	EXPONENT N	GREUTATE (KG)
	1600	70	F062105516010300	583	1021	1998	9.8	1.31	39.8
	1800	70	F062105518010300	656	1149	2248	11.0	1.31	44.7
	2000	70	F062105520010300	728	1276	2498	12.2	1.31	49.6
	2300	70	F062105523010300	838	1468	2873	14.0	1.31	56.9
	2600	70	F062105526010300	947	1659	3247	15.9	1.31	64.3
	3000	70	F062105530010300	1093	1915	3747	18.3	1.31	74.9
<b>Tip 22</b>									
	500	102	F062205505010300	228	403	796	3.0	1.33	14.9
	600	102	F062205506010300	274	484	955	3.7	1.33	17.8
	700	102	F062205507010300	320	564	1114	4.3	1.33	2.5
	900	102	F062205509010300	411	725	1432	5.5	1.33	26.0
	1000	102	F062205510010300	457	806	1591	6.1	1.33	28.7
	1100	102	F062205511010300	502	887	1750	6.7	1.33	31.5
	1200	102	F062205512010300	548	967	1909	7.3	1.33	34.3
	1600	102	F062205516010300	731	1289	2546	9.8	1.33	45.3
	1800	102	F062205518010300	822	1451	2864	11.0	1.33	5.8
	2000	102	F062205520010300	913	1612	3182	12.2	1.33	56.3
	2300	102	F062205523010300	1050	1854	3659	14.0	1.33	64.6
	2600	102	F062205526010300	1187	2095	4137	15.9	1.33	72.9
<b>Tip 33</b>									
	400	152	F063305504010300	250	443	879	3.6	1.34	18.0
	500	152	F063305505010300	312	553	1099	4.5	1.34	22.2
	600	152	F063305506010300	374	664	1318	5.4	1.34	26.6
	700	152	F063305507010300	437	775	1538	6.3	1.34	31
	800	152	F063305508010300	499	885	1758	7.2	1.34	34.2



# 550

ÎNĂLȚIME 550 mm	LUNGIME	ADÂNCIME	NR. ARTICOL	EFFEKT (W) 45/35/20°C	EFFEKT (W) 55/45/20°C	EFFEKT (W) 75/65/20°C	VOLUM (L)	EXPONENT N	GREUTATE (KG)
900	152		F063305509010300	561	996	1977	8.1	1.34	38.3
1000	152		F063305510010300	624	1106	2197	9.0	1.34	42.3
1100	152		F063305511010300	686	1217	2417	9.9	1.34	46.4
1200	152		F063305512010300	749	1328	2636	10.8	1.34	5.5
1400	152		F063305514010300	873	1549	3076	12.6	1.34	58.6
1600	152		F063305516010300	998	1770	3515	14.4	1.34	66.7
2000	152		F063305520010300	1248	2213	4394	18.0	1.34	83.0
2300	152		F063305523010300	1435	2545	5053	20.7	1.34	95.2
2600	152		F063305526010300	1622	2877	5712	23.4	1.34	109.4
3000	152		F063305530010300	1872	3319	6591	27.0	1.34	123.6



# 600

ÎNĂLȚIME 600 mm	LUNGIME	ADÂNCIME	NR. ARTICOL	EFFEKT (W) 45/35/20°C	EFFEKT (W) 55/45/20°C	EFFEKT (W) 75/65/20°C	VOLUM (L)	EXPONENT N	GREUTATE (KG)
<b>Tip 11</b>									
400	60		F061106004010300	119	208	407	1.3	1.31	7.9
700	60		F061106007010300	208	365	713	2.2	1.31	12.7
800	60		F061106008010300	238	417	814	2.6	1.31	14.4
900	60		F061106009010300	268	469	916	2.9	1.31	16.0
1100	60		F061106011010300	327	573	1120	3.5	1.31	19.2
1400	60		F061106014010300	417	729	1425	4.5	1.31	24.4
1600	60		F061106016010300	476	834	1629	5.1	1.31	27.3
1800	60		F061106018010300	536	938	1832	5.8	1.31	3.5
2000	60		F061106020010300	595	1042	2036	6.4	1.31	33.7
2300	60		F061106023010300	685	1198	2341	7.4	1.31	38.6
3000	60		F061106030010300	893	1563	3054	9.6	1.31	49.8
<b>Tip 21</b>									
400	70		F062106004010300	155	273	536	2.6	1.32	11.5
500	70		F062106005010300	194	341	670	3.3	1.32	14.4
600	70		F062106006010300	233	409	804	4.0	1.32	16.6
700	70		F062106007010300	272	478	938	4.6	1.32	19.2
800	70		F062106008010300	311	546	1072	5.3	1.32	21.7
900	70		F062106009010300	349	614	1206	5.9	1.32	24.3
1000	70		F062106010010300	388	682	1340	6.6	1.32	26.8
1100	70		F062106011010300	427	751	1474	7.3	1.32	29.4
1200	70		F062106012010300	466	819	1608	7.9	1.32	31.9
1400	70		F062106014010300	544	955	1876	9.2	1.32	37.3
1600	70		F062106016010300	621	1092	2144	10.6	1.32	42.1
2000	70		F062106020010300	777	1365	2680	13.2	1.32	52.3



## 600

ÎNĂLȚIME 600 mm	LUNGIME	ADÂNCIME	NR. ARTICOL	EFFEKT (W) 45/35/20°C	EFFEKT (W) 55/45/20°C	EFFEKT (W) 75/65/20°C	VOLUM (L)	EXPONENT N	GREUTATE (KG)
	2300	70	F062106023010300	893	1569	3082	15.2	1.32	60.0
	2600	70	F062106026010300	1009	1774	3484	17.2	1.32	67.6
	3000	70	F062106030010300	1165	2047	4020	19.8	1.32	77.8
<b>Tip 22</b>									
	400	102	F062206004010300	195	346	684	2.6	1.34	13.8
	500	102	F062206005010300	244	432	855	3.3	1.34	16.8
	600	102	F062206006010300	293	518	1025	4.0	1.34	19.6
	700	102	F062206007010300	342	605	1196	4.6	1.34	22.6
	800	102	F062206008010300	391	691	1367	5.3	1.34	25.5
	900	102	F062206009010300	440	777	1538	5.9	1.34	28.4
	1000	102	F062206010010300	488	864	1709	6.6	1.34	31.4
	1100	102	F062206011010300	537	950	1880	7.3	1.34	34.3
	1200	102	F062206012010300	586	1037	2051	7.9	1.34	37.2
	1400	102	F062206014010300	684	1209	2393	9.2	1.34	43.9
	1600	102	F062206016010300	782	1382	2734	10.6	1.34	49.0
	1800	102	F062206018010300	879	1555	3076	11.9	1.34	54.9
	2000	102	F062206020010300	977	1728	3418	13.2	1.34	6.7
	2300	102	F062206023010300	1124	1987	3931	15.2	1.34	69.5
	2600	102	F062206026010300	1270	2246	4443	17.2	1.34	78.3
	3000	102	F062206030010300	1465	2591	5127	19.8	1.34	90.0
<b>Tip 33</b>									
	400	152	F063306004010300	266	473	942	3.9	1.35	2.8
	600	152	F063306006010300	399	710	1414	5.9	1.35	28.9
	700	152	F063306007010300	466	828	1649	6.9	1.35	33.3
	800	152	F063306008010300	532	946	1885	7.8	1.35	37.6



# 600

ÎNĂLȚIME 600 mm	LUNGIME	ADÂNCIME	NR. ARTICOL	EFFEKT (W) 45/35/20°C	EFFEKT (W) 55/45/20°C	EFFEKT (W) 75/65/20°C	VOLUM (L)	EXPONENT N	GREUTATE (KG)
900	152	152	F063306009010300	599	1065	2120	8.8	1.35	42.2
1000	152	152	F063306010010300	665	1183	2356	9.8	1.35	46.4
1100	152	152	F063306011010300	732	1301	2592	10.8	1.35	5.9
1200	152	152	F063306012010300	798	1420	2827	11.8	1.35	55.2
1800	152	152	F063306018010300	1198	2129	4241	17.6	1.35	81.5
2000	152	152	F063306020010300	1331	2366	4712	19.6	1.35	9.4
2300	152	152	F063306023010300	1530	2721	5419	22.5	1.35	105.5
2600	152	152	F063306026010300	1730	3076	6126	25.5	1.35	116.7
3000	152	152	F063306030010300	1996	3549	7068	29.4	1.35	134.3



## 900

ÎNĂLȚIME 900 mm	LUNGIME	ADÂNCIME	NR. ARTICOL	EFFEKT (W) 45/35/20°C	EFFEKT (W) 55/45/20°C	EFFEKT (W) 75/65/20°C	VOLUM (L)	EXPONENT N	GREUTATE (KG)
<b>Tip 11</b>									
	400	60	F061109004010300	166	291	571	1.8	1.32	11.9
	500	60	F061109005010300	208	364	714	2.3	1.32	14.3
	600	60	F061109006010300	249	437	856	2.7	1.32	16.8
	700	60	F061109007010300	291	510	999	3.1	1.32	19.2
	800	60	F061109008010300	332	583	1142	3.6	1.32	21.7
	900	60	F061109009010300	374	655	1284	4.0	1.32	24.2
	1000	60	F061109010010300	415	728	1427	4.5	1.32	26.7
	1100	60	F061109011010300	457	801	1570	5.0	1.32	29.2
	1400	60	F061109014010300	581	1019	1998	6.3	1.32	36.6
	1600	60	F061109016010300	664	1165	2283	7.2	1.32	41.6
	1800	60	F061109018010300	747	1311	2569	8.1	1.32	46.5
	2000	60	F061109020010300	830	1456	2854	9.0	1.32	51.5
	2300	60	F061109023010300	955	1675	3282	10.3	1.32	58.9
	2600	60	F061109026010300	1079	1893	3710	11.7	1.32	66.4
	3000	60	F061109030010300	1245	2185	4281	13.5	1.32	76.3
<b>Tip 21</b>									
	400	70	F062109004010300	212	376	744	3.6	1.34	16.7
	600	70	F062109006010300	318	563	1117	5.4	1.34	24.3
	700	70	F062109007010300	371	657	1303	6.3	1.34	28.6
	800	70	F062109008010300	424	751	1489	7.2	1.34	31.8
	900	70	F062109009010300	477	845	1675	8.1	1.34	35.6
	1000	70	F062109010010300	530	939	1861	9.0	1.34	39.5
	1100	70	F062109011010300	583	1033	2047	9.9	1.34	43.2
	1400	70	F062109014010300	742	1315	2605	12.6	1.34	54.5



## 900

ÎNĂLȚIME 900 mm	LUNGIME	ADÂNCIME	NR. ARTICOL	EFFEKT (W) 45/35/20°C	EFFEKT (W) 55/45/20°C	EFFEKT (W) 75/65/20°C	VOLUM (L)	EXPONENT N	GREUTATE (KG)
	1800	70	F062109018010300	955	1690	3350	16.2	1.34	69.6
	2000	70	F062109020010300	1061	1878	3722	18.0	1.34	77.2
	2300	70	F062109023010300	1220	2160	4280	20.7	1.34	88.5
	3000	70	F062109030010300	1591	2817	5583	27.0	1.34	115.0
<b>Tip 22</b>	400	102	F062209004010300	268	478	955	3.6	1.36	19.8
	500	102	F062209005010300	335	597	1194	4.5	1.36	24.2
	600	102	F062209006010300	402	717	1433	5.4	1.36	28.7
	700	102	F062209007010300	469	836	1672	6.3	1.36	33.2
	900	102	F062209009010300	603	1075	2149	8.1	1.36	42.2
	1100	102	F062209011010300	737	1314	2627	9.9	1.36	51.2
	1200	102	F062209012010300	804	1433	2866	10.8	1.36	55.7
	1400	102	F062209014010300	938	1672	3343	12.6	1.36	64.7
	1600	102	F062209016010300	1072	1911	3821	14.4	1.36	73.7
	2000	102	F062209020010300	1339	2389	4776	18.0	1.36	91.6
	2300	102	F062209023010300	1540	2747	5492	20.7	1.36	107.2
	2600	102	F062209026010300	1741	3106	6209	23.4	1.36	118.7
	3000	102	F062209030010300	2009	3583	7164	27.0	1.36	136.6
<b>Tip 33</b>	400	152	F063309004010300	364	651	1304	5.3	1.36	28.7
	600	152	F063309006010300	547	976	1956	8.0	1.36	42.9
	700	152	F063309007010300	638	1139	2282	9.3	1.36	48.8
	800	152	F063309008010300	729	1302	2608	10.6	1.36	55.5
	900	152	F063309009010300	820	1465	2934	12.0	1.36	62.3
	1000	152	F063309010010300	911	1627	3260	13.0	1.36	69.0



# 900

ÎNĂLȚIME 900 mm	LUNGIME	ADÂNCIME	NR. ARTICOL	EFFEKT (W) 45/35/20°C	EFFEKT (W) 55/45/20°C	EFFEKT (W) 75/65/20°C	VOLUM (L)	EXPONENT N	GREUTATE (KG)
1100	152		F063309011010300	1002	1790	3586	14.6	1.36	75.6
1200	152		F063309012010300	1093	1953	3912	16.0	1.36	82.0
1400	152		F063309014010300	1275	2278	4564	19.0	1.36	96.0
1600	152		F063309016010300	1457	2604	5216	21.3	1.36	111.3
1800	152		F063309018010300	1640	2929	5868	23.9	1.36	122.6
2000	152		F063309020010300	1822	3255	6520	26.6	1.36	136.0
2300	152		F063309023010300	2095	3743	7498	30.6	1.36	156.8
2600	152		F063309026010300	2368	4231	8476	34.6	1.36	176.2