



Datablad

2026-06-28

Compact C

Den tradisjonelle radiatoren med det bredeste utvalget på markedet.

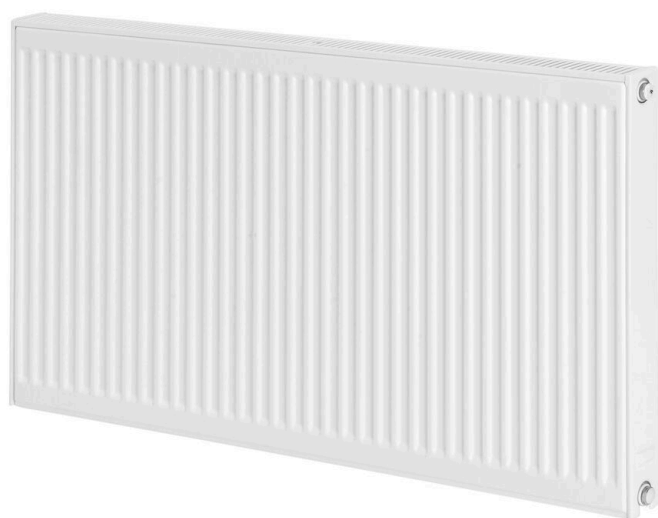

- ✓ Høy trykkmotstand
- ✓ Estetisk design
- ✓ Fleksibel installasjon
- ✓ Effektiv varmfordeling
- ✓ EPD

Compact er en tradisjonell panelradiator for lukkede, vannbårne varmesystemer med nøytralt design. Compact panelradiator er utstyrt med fire G 1/2" koblinger med innvendig gjenge for sidetilkobling på høyre og venstre side. Dette er en radiator av høy kvalitet og flott finish med markedets bredeste sortiment. Compact er utformet for optimal varmfordeling i henhold til EN442-1 standarden. Compact leveres med premonterte sideplater og topprist med barnesikring. Konsoller, rist, sideplater, blindplugg og lufteskruer medfølger. Driftsforholdene må vurderes og monteringsanvisningen skal følges. Standard hvit RAL 9016 finish (andre farger er tilgjengelig på forespørsel mot pristillegg). Maks. driftstemperatur: 110 °C Maks. driftstrykk: 10 bar 10 års garanti.



Bruksområde

Ideell for fleretasjes bygninger, fjernvarmesystemer og større installasjoner. Kompatibel med systemer med maksimale driftstemperaturer på 110°C og driftstrykk: 10 bar

Dimensjonering

Bruk vår designtjeneste for detaljert utvalg, eller se i vår brosjyre for raskt utvalg.

Bruk

Tilkobling skjer via 4 x G 1/2" sidetilkobling, med turledning i toppen og retur i bunnen. Kan også kobles til diagonalt uten effekttap. Seriekobling av flere radiatorer anbefales ikke på grunn av fare for stort effekttap på den seriekoblede radiatoren. Monteres i

tørre miljøer, ikke egnet der det forekommer høy luftfuktighet.

Teknisk beskrivelse

Tekst: Compact (33.3) radiator fra Purmo er designet for høytrykksapplikasjoner med et maksimalt arbeidstrykk på 10 bar og en maksimal driftstemperatur på 110°C. Den har dyptrukket, lavkarbon kaldvalset stål i samsvar med EN 10130. Denne radiatoren inkluderer vertikale vannkanaler med 33.3 mm avstand for effektiv varmfordeling og leveres med ferdigmonterte sidepaneler og en toppgrill. Med standard hvit RAL 9016 er andre fargealternativer tilgjengelige på forespørsel. Tilkoblinger gjøres via 4 x G 1/2" sideåpninger, og radiatoren leveres med veggfester, plugg og en luftventil. Tilgjengelig i flere størrelser, den dekker både bolig- og kommersielle behov, og passer sømløst i fleretasjes bygninger og fjernvarmesystemer



Spesifikasjoner

KJENNETEGN	ENHET	VERDIER
ETIM-klasse		EC011022
Materiale		Stål
Type		11, 21, 22, 33
Overflatestruktur		Profilert
Maks arbeidstrykk	bar	10
Antal standardanslutninger		4
Varmeklassifisering i henhold til anerkjent EN 442-laboriestandard		Ja
Maks. driftstemperatur	°C	110
Standardfarge		Ja
Farge		Hvit
RAL-nummer		9016
Grill/Dekkplate		Ja
Grill/Dekkplate		Ja
Glansverdi		Blank
Gjengedimensjon (tommer)		1/2"
Tilkoblingsgjenge		Innvendige gjenger
Med ettpunktstilkobling		Ja
Med lufttilkobling		Ja
Med lufteventil/lufteventil		Ja
Med tappealternativ		Ja



Dokument

DOKUMENT	DOKUMENTTYPE	LINK
Datablad Kulörer - Panelradiatorer og konvektorer	Brochure	https://asset.productmarketingcloud.com/api/assetstorage/3577_68e483fa-ca55-43d0-bcd9-2d8f352bad7b
Bruk og vedlikehold - Radiatorer og konvektorer	User	https://asset.productmarketingcloud.com/api/assetstorage/3577_b6fde556-a645-4cb0-9dc2-eb976d73f293
Datablad Flamingo-FLA fra V11 2023	Installation	https://asset.productmarketingcloud.com/api/assetstorage/3577_771694c6-3b55-474a-b101-a7a4f41829b9



Ressurser



ProductImage - Purmo Compact, C, detail above.



ProductImage - Purmo Compact, C, product image 30 degrees.

COMPACT (mm)				
	C11		C21s, C22, C33	
A	a1	a2	a1	a2
400-1600	117	-	133	-
1800	117	917	133	900
2000	117	1017	133	1000
2300	117	1150	133	1167
2600	117	1317	133	1300
3000	117	1517	133	1500

DimensionalDrawing - Compact-table-drawing a

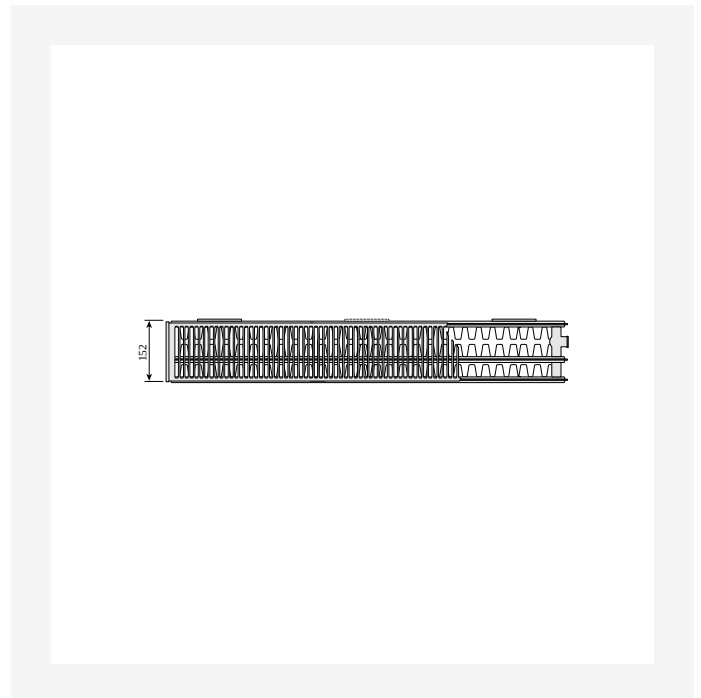

DimensionalDrawing - Compact, type 33 ovenfra



Resser

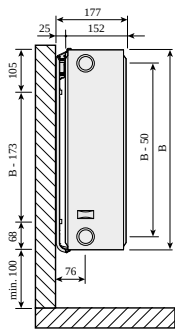

DimensionalDrawing - Compact, typ 33 sidevising

DimensionalDrawing - Compact, typ 22 ovenfra

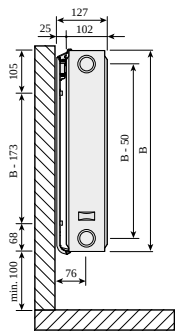

DimensionalDrawing - Compact, typ 22 sidevising

DimensionalDrawing - Compact, typ 21 ovenfra



Resser

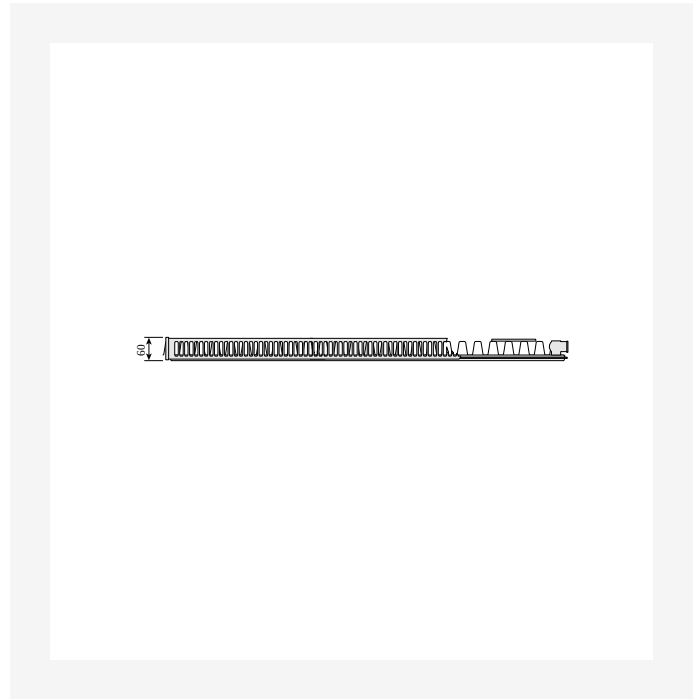
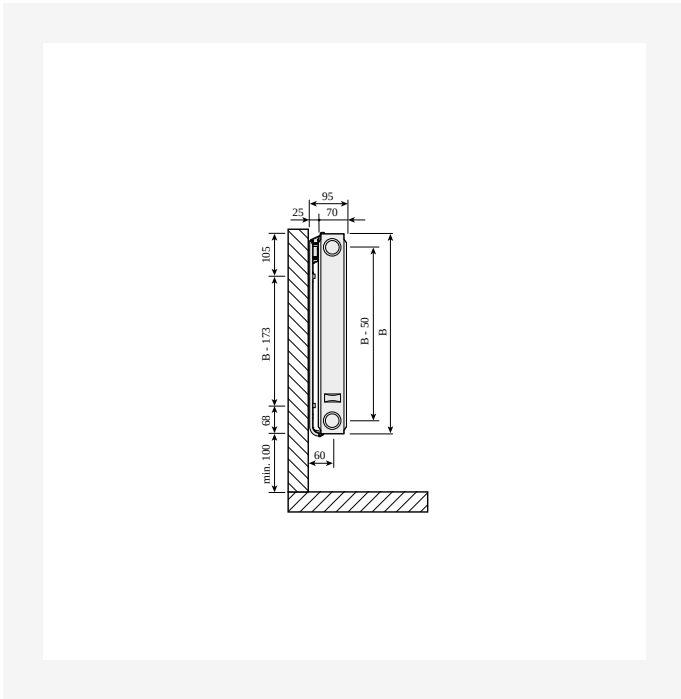

DimensionalDrawing - Compact, type 21 sidevising

DimensionalDrawing - Compact, type 11 ovenfra

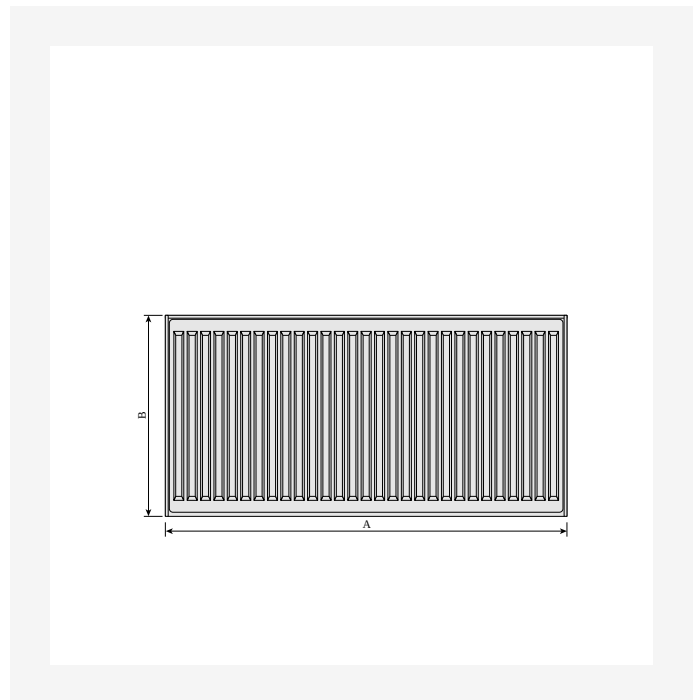
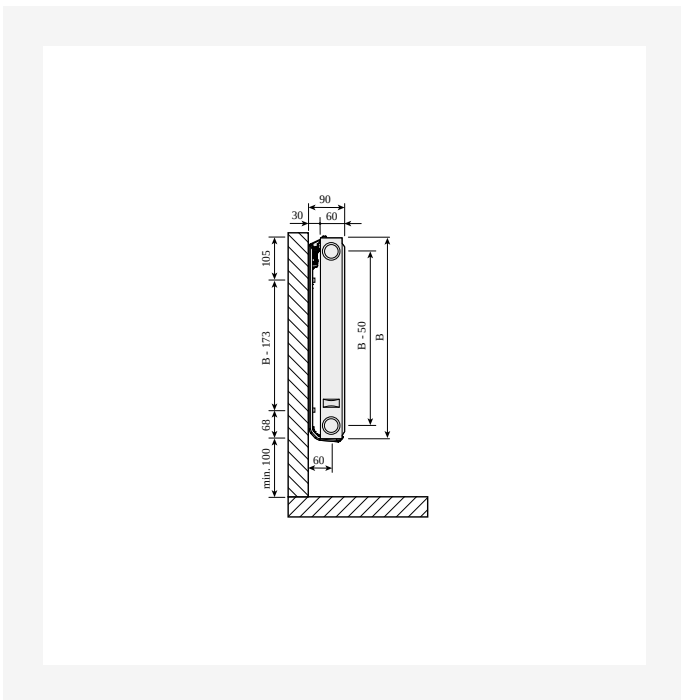

DimensionalDrawing - Compact, type 11, sidevising

DimensionalDrawing - Compact, sett forfra



Ressurser

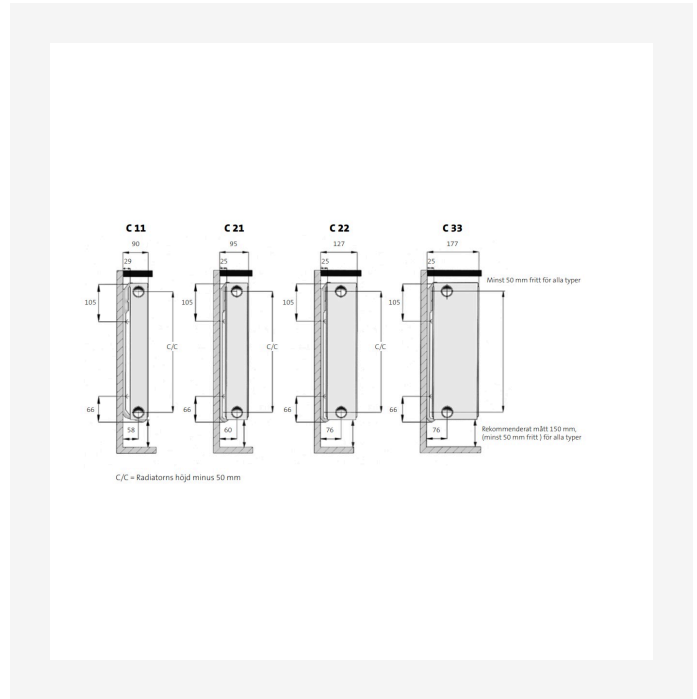
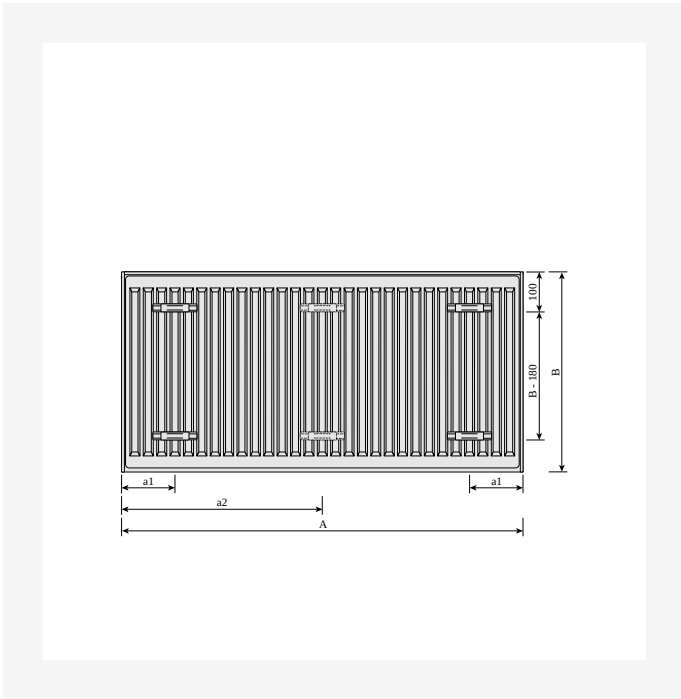

DimensionalDrawing - Compact, bakfra

DimensionalDrawing - 1.12 Installationsmått

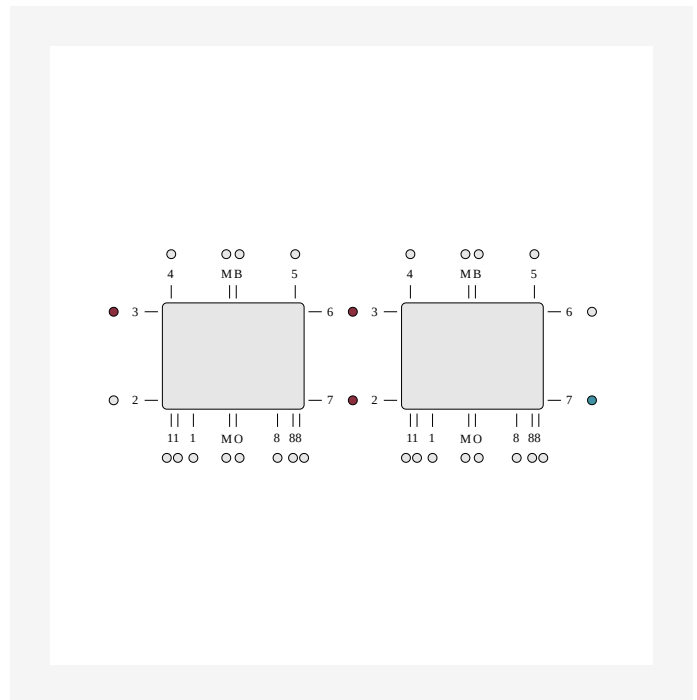
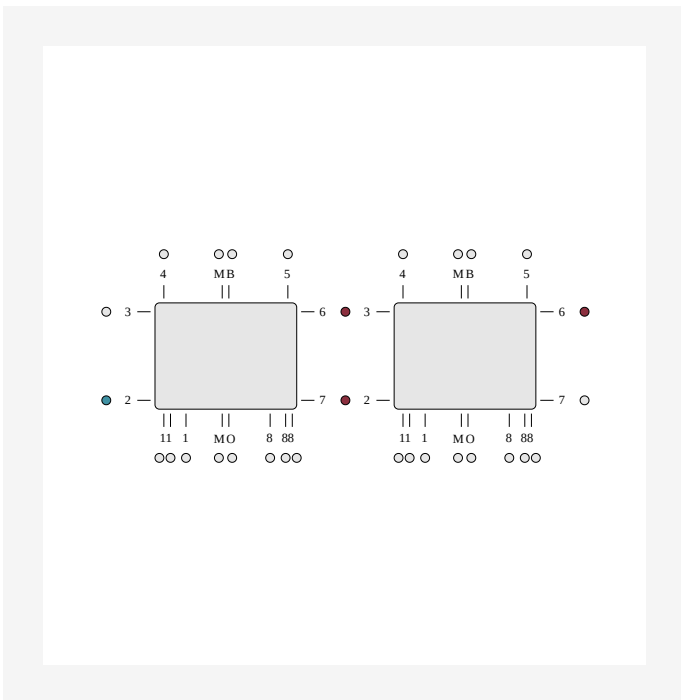

DimensionalDrawing - Seriekobling høyre ETIM 62

DimensionalDrawing - Diagonal seriekobling venstre ETIM 37



Ressurser

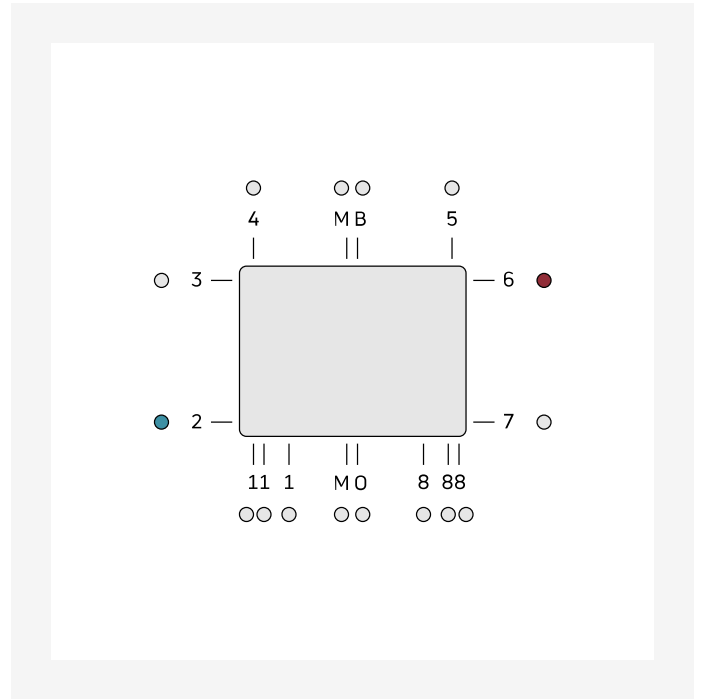
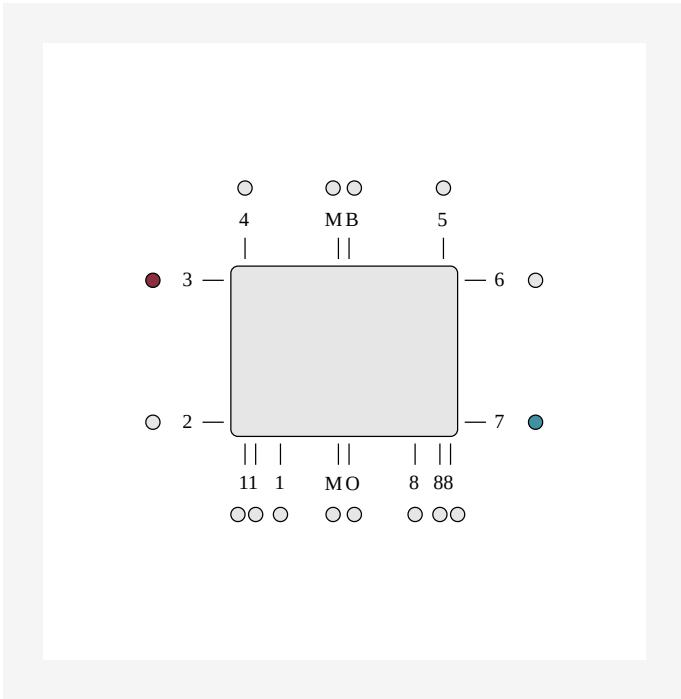

DimensionalDrawing - Diagonal forbindelse ETIM 37

DimensionalDrawing - Diagonal forbindelse ETIM 62.

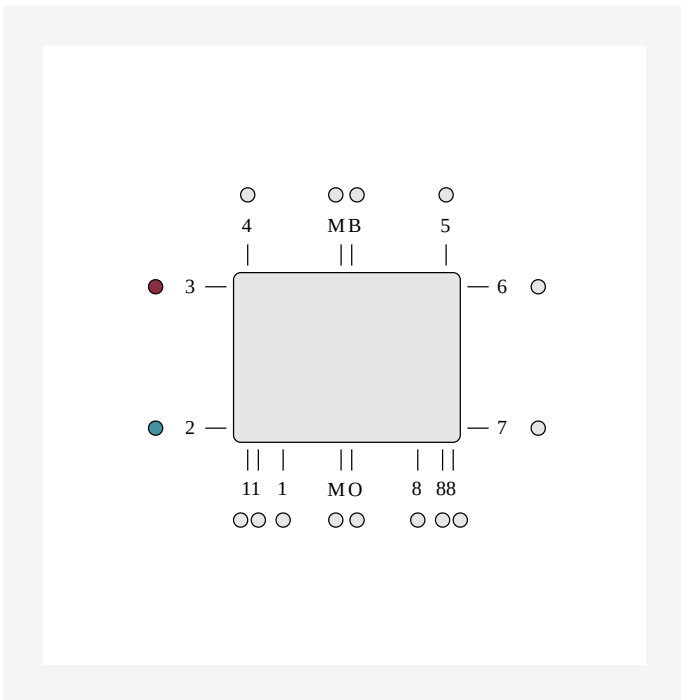

DimensionalDrawing - Sidetilkobling venstre ETIM 32



Relaterte produkter



Sensor



Topprist Purmo/TP



Air



Lufteskruer og blindpluggsett



Reparasjonsslakk



Sidepanel Purmo/TP



Lufteskruer G1/2"



Veggfeste Monclac



Luftenøkkel



Flex Radiatorventilsett

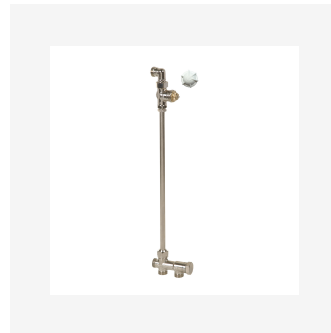

Ventilsett Evoflow



Veggfeste SSMS



Relaterte produkter



Låsebøyle

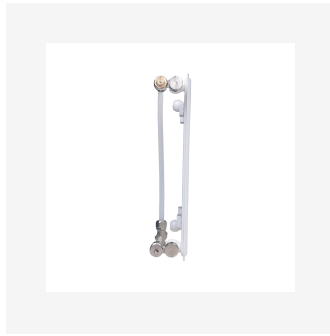

Radiatorventilsett FLK



Termostat Evosense



Returventil RV

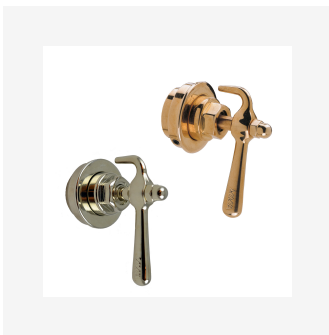

Slottsventil rattvrider



Termostat Evosense Sprint



Dekekkskive for gulvkonsoll



Evoflow Radiatorventil



Slottsventil FV



Termostat Evosense Public



Returventil RRV

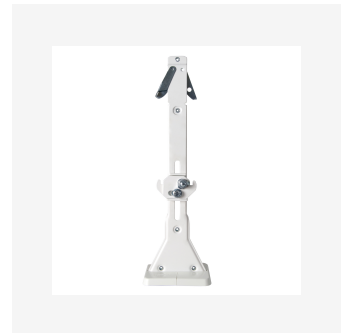

Gulvkonsoll Purmo Monclac



Relaterte produkter



Slottsventil returventil



Veggavstand



Termostat Evosense Remote



Sikkerhetskonsoller



300

HØYDE 300 mm	LENGDE	DYBDE	Artikkelnr/ NOBB (V)	Artikkelnr/ NOBB (H)	EFFEKT (W) 45/35/20°C	EFFEKT (W) 55/45/20°C	EFFEKT (W) 60/45/20°C	VOLUM (l)	N- EKSPONENT	VEKT (kg)
Type 11										
	400	60		8270001	65	113	122	0.7	1.30	4.4
	500	60		8270002	81	141	152	0.8	1.30	5.1
	600	60		8270003	97	169	183	1.0	1.30	5.9
	700	60	F061103007010300	8270004	113	197	213	1.2	1.30	6.7
	800	60	F061103008010300	8270005	129	225	244	1.4	1.30	7.5
	900	60		8270006	145	253	274	1.5	1.30	8.3
	1000	60		8270007	162	281	305	1.7	1.30	9.2
	1100	60		8270008	178	309	336	1.9	1.30	10.0
	1200	60		8270009	194	338	366	2.0	1.30	1.6
	1400	60		8270011	226	394	427	2.4	1.30	12.2
	1600	60	F061103016010300	8270012	259	450	488	2.7	1.30	13.8
	1800	60		8270013	291	506	549	3.1	1.30	15.4
	2000	60		8270014	323	563	610	3.4	1.30	17.0
	2300	60		8270015	372	647	701	3.9	1.30	19.4
	2600	60	F061103026010300	8270016	420	731	793,792	4.4	1.30	21.7
	3000	60		8270017	485	844	915	5.1	1.30	24.9
Type 21										
	400	70		8270125	92	158	171	1.4	1.28	6.2
	500	70		8270126	115	198	214	1.7	1.28	7.4
	600	70		8270127	138	237	257	2.0	1.28	8.6
	700	70		8270128	160	277	300	2.4	1.28	10.0
	800	70		8270129	183	317	343	2.7	1.28	11.3
	900	70		8270131	206	356	386	3.1	1.28	12.3
	1000	70	F062103010010300	8270132	229	396	428	3.4	1.28	13.6



300

HØYDE 300 mm	LENGDE	DYBDE	Artikelnr/ NOBB (V)	Artikelnr/ NOBB (H)	EFFEKT (W) 45/35/20°C	EFFEKT (W) 55/45/20°C	EFFEKT (W) 60/45/20°C	VOLUM (l)	N- EKSPONENT	VEKT (kg)
	1100	70	8270133		252	435	471	3.7	1.28	14.8
	1200	70	8270134		275	475	514	4.1	1.28	16.4
	1400	70	8270135		321	554	599	4.8	1.28	18.7
	1600	70	8270136		367	633	686	5.4	1.28	21.1
	1800	70	F062103018010300	8270137	412	712	771	6.1	1.28	23.6
	2000	70	8270138		458	791	857	6.8	1.28	26.1
	2300	70	8270139		527	910	985	7.8	1.28	30.0
	2600	70	8270141		596	1029	1114	8.8	1.28	33.7
	3000	70	8270142		687	1187	1285	10.2	1.28	38.7
Type 22										
	400	102	8270236		112	197	213	1.4	1.31	7.2
	500	102	8270237		141	246	267	1.7	1.31	8.5
	600	102	8270238		169	295	321	2.0	1.31	10.1
	700	102	8270239		197	345	374	2.4	1.31	11.4
	800	102	8270241		225	394	427	2.7	1.31	12.8
	900	102	8270242		253	443	481	3.1	1.31	14.2
	1000	102	8270243		282	492	534	3.4	1.31	15.6
	1100	102	8270244		310	542	587	3.7	1.31	17.4
	1200	102	8270245		338	591	641	4.1	1.31	18.5
	1400	102	8270246		394	689	747	4.8	1.31	21.3
	1600	102	F062203016010300	8270247	451	788	854	5.4	1.31	24.2
	1800	102	8270248		507	886	961	6.1	1.31	27.1
	2000	102	F062203020010300	8270249	563	985	1068,1067	6.8	1.31	29.9
	2300	102	8270251		647	1132	1228	7.8	1.31	34.1
	2600	102	8270252		732	1280	1388	8.8	1.31	38.5
	3000	102	8270253		845	1477	1602	10.2	1.31	44.9



300

HØYDE 300 mm	LENGDE	DYBDE	Artikelnr/ NOBB (V)	Artikelnr/ NOBB (H)	EFFEKT (W) 45/35/20°C	EFFEKT (W) 55/45/20°C	EFFEKT (W) 60/45/20°C	VOLUM (l)	N- EKSPONENT	VEKT (kg)
Type 33										
400	152		8266162		157	275	299	2.0	1.31	1.3
500	152		8266163		197	344	374	2.5	1.31	12.4
600	152		8266164		236	413	448	3.1	1.31	14.5
700	152	F063303007010300	8266165		275	482	523	3.6	1.31	16.7
800	152		8266166		314	551	598	4.1	1.31	18.8
900	152	F063303009010300	8266167		354,353	620	672	4.6	1.31	2.9
1000	152		8266168		393	688	747	5.1	1.31	23.5
1100	152		8266169		432	757	822	5.6	1.31	25.2
1200	152		8266171		471	826	896	6.1	1.31	27.3
1400	152		8266172		550	964	1046	7.1	1.31	31.6
1600	152		8266173		629	1101	1195	8.2	1.31	35.8
1800	152		8266174		707	1239	1344	9.2	1.31	4.7
2000	152		8266175		786	1377	1493	10.2	1.31	44.3
2300	152	F063303023010300	8266176		904	1583	1717	11.7	1.31	5.7
2600	152	F063303026010300	8266177		1022,1021	1790	1941	13.3	1.31	57.9
3000	152		8266178		1179	2065	2240	15.3	1.31	65.6



400

HØYDE 400 mm	LENGDE	DYBDE	Artikelnr/ NOBB (V)	Artikelnr/ NOBB (H)	EFFEKT (W) 45/35/20°C	EFFEKT (W) 55/45/20°C	EFFEKT (W) 60/45/20°C	VOLUM (l)	N- EKSPONENT	VEKT (kg)
Type 11										
400	60		8270025		84	146	158	0.9	130	5.5
500	60		8270026		105	183	198	1.1	130	6.5
600	60	F061104006010300	8270027		126	219	238	1.3	130	7.6
700	60		8270028		147	256	277	1.5	130	8.7
800	60	F061104008010300	8270029		168	292	317	1.8	130	9.7
900	60		8270031		189	329	357	2.0	130	18
1000	60		8270032		210	366	396	2.2	130	11.8
1100	60		8270033		231	402	436	2.4	130	12.9
1200	60		8270034		251	439	475	2.6	130	14.0
1400	60		8270035		293	512	554	3.1	130	16.1
1600	60		8270036		335	585	634	3.5	130	18.2
1800	60	F061104018010300	8270037		377	658	713	4.0	130	2.4
2000	60	F061104020010300	8270038		419	731	792	4.4	130	22.5
2300	60		8270039		482	841	911	5.1	130	25.7
2600	60		8270041		545	950	1030	5.7	130	28.9
3000	60		8270042		629	1097	1189	6.6	130	33.2
Type 21										
400	70		8270148		114	199	215	1.8	129	7.7
500	70		8270149		143	249	270	2.3	129	9.4
600	70		8270151		172	298	323	2.7	129	11.1
700	70	F062104007010300	8270152		200	348	377	3.1	129	12.8
800	70	F062104008010300	8270153		229	398	431	3.6	129	14.5
900	70		8270154		258	448	485	4.0	129	16.2
1000	70		8270155		286	497	539	4.5	129	17.9
1100	70	F062104011010300	8270156		315	547	592	5.0	129	19.6



400

HØYDE 400 mm	LENGDE	DYBDE	Artikelnr/ NOBB (V)	Artikelnr/ NOBB (H)	EFFEKT (W) 45/35/20°C	EFFEKT (W) 55/45/20°C	EFFEKT (W) 60/45/20°C	VOLUM (l)	N- EKSPONENT	VEKT (kg)
1200	70	F062104012010300	8270157		344	597	647,646	5.4	1.29	21.3
1400	70		8270158		401	696	754	6.3	1.29	24.6
1600	70	F062104016010300	8270159		458	796	862	7.2	1.29	28.3
1800	70		8270161		515	895	969	8.1	1.29	31.4
2000	70		8270162		572	994	1077	9.0	1.29	34.8
2300	70	F062104023010300	8270163		658	1144	1239	10.3	1.29	39.9
2600	70		8270164		744	1293	1401	11.7	1.29	44.9
3000	70		8270165		859	1492	1616	13.5	1.29	51.7
Type 22										
400	102	F062204004010300	8270261		142	249	270	1.8	1.32	9.2
500	102		8270262		178	311	338	2.3	1.32	11.3
600	102		8270263		213	374	406	2.7	1.32	13.3
700	102		8270264		248	436	473	3.1	1.32	15.0
800	102		8270265		284	498	541	3.6	1.32	16.9
900	102		8270266		319	560	608	4.0	1.32	18.8
1000	102		8270267		355	623	676	4.5	1.32	2.7
1100	102	F062204011010300	8270268		390	685	743	5.0	1.32	22.6
1200	102		8270269		426	747	811	5.4	1.32	24.6
1400	102	F062204014010300	8270271		497,496	872	946	6.3	1.32	28.4
1600	102		8270272		568	996	1081	7.2	1.32	32.3
1800	102		8270273		639	1121	1216	8.1	1.32	36.1
2000	102		8270274		709	1245	1351	9.0	1.32	40.0
2300	102		8270275		816	1432	1554	10.3	1.32	45.7
2600	102		8270276		922	1619	1757	11.7	1.32	51.6
3000	102	F062204030010300	8270277		1064	1868	2027,2026	13.5	1.32	59.2

Type 33



400

HØYDE 400 mm	LENGDE	DYBDE	Artikelnr/ NOBB (V)	Artikelnr/ NOBB (H)	EFFEKT (W) 45/35/20°C	EFFEKT (W) 55/45/20°C	EFFEKT (W) 60/45/20°C	VOLUM (l)	N- EKSPONENT	VEKT (kg)
400	152		8266179		196	345	375	2.7	1.33	13.5
500	152		F063304005010300	8266181	245	432	469,468	3.4	1.33	16.4
600	152		8266182		294	518	562	4.0	1.33	19.2
700	152		F063304007010300	8266183	343	604	656	4.7	1.33	22.1
800	152		8266184		392	691	750	5.4	1.33	25.0
900	152		8266185		441	777	843	6.0	1.33	27.9
1000	152		F063304010010300	8266186	490	863	937	6.7	1.33	3.8
1100	152		8266187		539	950	1031	7.4	1.33	33.6
1200	152		8266188		588	1036	1125	8.0	1.33	36.5
1400	152		8266189		686	1209	1312	9.4	1.33	42.3
1600	152		8266191		784	1381	1499	10.7	1.33	48.5
1800	152		F063304018010300	8266192	883,882	1554	1687,1686	12.1	1.33	53.9
2000	152		8266193		980	1726	1874	13.4	1.33	59.6
2300	152		8266194		1128	1985	2155	15.4	1.33	68.2
2600	152		8266195		1274	2244	2436	17.4	1.33	76.9
3000	152		8266196		1471	2590	2811	20.1	1.33	88.4



450

HØYDE 450 mm	LENGDE	DYBDE	Artikelnr/ NOBB (V)	Artikelnr/ NOBB (H)	EFFEKT (W) 45/35/20°C	EFFEKT (W) 55/45/20°C	EFFEKT (W) 60/45/20°C	VOLUM (l)	N- EKSPONENT	VEKT (kg)
Type 11										
400	60		8270045		93	162	176	1.0	1.30	6.4
500	60		8270046		116	203	220	1.3	1.30	7.6
600	60		8270047		139	243	264	1.5	1.30	8.9
700	60		8270048		163	284	308	1.8	1.30	1.2
800	60	F061104508010300		8270049	186	325	352	2.0	1.30	11.4
900	60		8270051		209	365	396	2.3	1.30	12.7
1000	60		8270052		232	406	440	2.5	1.30	14.0
1100	60		8270053		256	446	484	2.8	1.30	15.2
1200	60	F061104512010300		8270054	279	487	528	3.0	1.30	16.5
1400	60		8270055		325	568	616	3.5	1.30	19.4
1600	60		8270056		372	649	704	4.0	1.30	21.5
1800	60	F061104518010300		8270057	418	730	792,791	4.5	1.30	24.5
2000	60		8270058		465	811	880	5.0	1.30	26.6
2300	60		8270059		535	933	1011	5.8	1.30	3.4
2600	60	F061104526010300		8270061	604	1055	1143	6.5	1.30	34.2
3000	60	F061104530010300		8270062	697	1217	1319	7.5	1.30	39.2
Type 21										
400	70		8270171		125	218	236	2.0	1.30	9.3
500	70		8270172		157	273	296	2.5	1.30	11.3
600	70		8270173		188	327	355	3.0	1.30	13.4
700	70		8270174		219	382	414	3.5	1.30	15.4
800	70		8270175		250	436	473	4.0	1.30	17.4
900	70		8270176		282	491	532	4.5	1.30	19.4
1000	70		8270177		313	545	591	5.0	1.30	21.4
1100	70	F062104511010300		8270178	344	600	650	5.5	1.30	23.5



450

HØYDE 450 mm	LENGDE	DYBDE	Artikelnr/ NOBB (V)	Artikelnr/ NOBB (H)	EFFEKT (W) 45/35/20°C	EFFEKT (W) 55/45/20°C	EFFEKT (W) 60/45/20°C	VOLUM (l)	N- EKSPONENT	VEKT (kg)
1200	70		8270179		376	654	709	6.0	1.30	25.5
1400	70		8270181		438	764	828	7.0	1.30	29.5
1600	70		8270182		501	873	946	8.0	1.30	33.6
1800	70		F062104518010300	8270183	564,563	982	1064	9.0	1.30	37.7
2000	70		8270184		626	1091	1182	10.0	1.30	41.6
2300	70		8270185		720	1254	1360	11.5	1.30	47.7
2600	70		8270186		814	1418	1537	13.0	1.30	53.8
3000	70		8270187		939	1636	1773	15.0	1.30	61.9
Type 22										
400	102		F062204504010300	8266108	156	274	298,297	2.0	1.32	1.6
500	102		8266109		195	343	372	2.5	1.32	13.0
600	102		8266111		234	411	446	3.0	1.32	15.3
700	102		8266112		273	480	521	3.5	1.32	17.6
800	102		8266113		312	548	595	4.0	1.32	19.9
900	102		8266114		351	617	669	4.5	1.32	22.2
1000	102		8266115		390	685	744	5.0	1.32	24.5
1100	102		8266116		429	754	818	5.5	1.32	26.8
1200	102		8266117		468	822	892	6.0	1.32	29.1
1400	102		8266118		546	960	1042	7.0	1.32	33.7
1600	102		8266119		623	1097	1190	8.0	1.32	38.3
1800	102		F062204518010300	8266121	702	1234	1339	9.0	1.32	43.0
2000	102		8266122		779	1371	1488	10.0	1.32	47.6
2300	102		8266123		896	1576	1711	11.5	1.32	54.5
2600	102		8266124		1013	1782	1934	13.0	1.32	61.4
3000	102		F062204530010300	8266125	1169	2056	2232,2231	15.0	1.32	7.6

Type 33



450

HØYDE 450 mm	LENGDE	DYBDE	Artikelnr/ NOBB (V)	Artikelnr/ NOBB (H)	EFFEKT (W) 45/35/20°C	EFFEKT (W) 55/45/20°C	EFFEKT (W) 60/45/20°C	VOLUM (l)	N- EKSPONENT	VEKT (kg)
	400	152		8266197	215	379	411	3.0	1.33	15.8
	500	152		8266198	268	473	514	3.8	1.33	19.2
	600	152		8266199	322	568	617	4.5	1.33	22.7
	700	152		8266201	375	663	719	5.3	1.33	26.1
	800	152	F063304508010300	8266202	429	757	822	6.0	1.33	29.6
	900	152		8266203	483	852	925	6.8	1.33	33.7
	1000	152		8266204	536	947	1028	7.5	1.33	36.5
	1100	152		8266205	590	1041	1131	8.3	1.33	39.9
	1200	152		8266206	644	1136	1234	9.0	1.33	43.3
	1400	152	F063304514010300	8266207	751	1326	1440,1439	10.5	1.33	5.2
	1600	152	F063304516010300	8266208	858	1515	1645	12.0	1.33	57.1
	1800	152		8266209	965	1704	1850	13.5	1.33	64.1
	2000	152		8266211	1073	1894	2056	15.0	1.33	7.9
	2300	152		8266212	1234	2178	2365	17.3	1.33	81.2
	2600	152		8266213	1394	2462	2673	19.5	1.33	91.6
	3000	152		8266214	1609	2840	3084	22.5	1.33	107.4



500

HØYDE 500 mm	LENGDE	DYBDE	Artikelnr/ NOBB (V)	Artikelnr/ NOBB (H)	EFFEKT (W) 45/35/20°C	EFFEKT (W) 55/45/20°C	EFFEKT (W) 60/45/20°C	VOLUM (l)	N- EKSPONENT	VEKT (kg)
Type 11										
400	60		8270065		102	178	193	1.1	1.31	6.5
500	60		8270066		127	223	241	1.4	1.31	7.8
600	60		8270067		153	267	290	1.6	1.31	9.2
700	60		8270068		178	312	338	1.9	1.31	16
800	60	F061105008010300	8270069		204	356	386	2.2	1.31	12.0
900	60	F061105009010300	8270071		229	401	434	2.4	1.31	13.3
1000	60		8270072		255	445	483	2.7	1.31	14.8
1100	60		8270073		280	490	531	3.0	1.31	16.4
1200	60		8270074		306	534	579	3.2	1.31	17.5
1400	60		8270075		357	623	676	3.8	1.31	2.2
1600	60		8270076		408	712	772	4.3	1.31	22.9
1800	60		8270077		459	801	869	4.9	1.31	25.7
2000	60		8270078		510	890	965	5.4	1.31	28.4
2300	60	F061105023010300	8270079		586	1024	1110	6.2	1.31	32.6
2600	60		8270081		663	1158	1255	7.0	1.31	36.7
3000	60		8270082		764	1336	1448	8.1	1.31	43.0
Type 21										
400	70	F062105004010300	8270191		136	237	257	2.2	1.31	9.6
500	70		8270192		170	296	321	2.8	1.31	11.7
600	70		8270193		204	356	386	3.3	1.31	13.8
700	70	F062105007010300	8270194		237	415	450	3.9	1.31	15.9
800	70		8270195		271	474	514	4.4	1.31	18.1
900	70		8270196		305	533	578	5.0	1.31	2.1
1000	70		8270197		339	593	643	5.5	1.31	22.2
1100	70	F062105011010300	8270198		373	652	707	6.0	1.31	24.3



500

HØYDE 500 mm	LENGDE	DYBDE	Artikelnr/ NOBB (V)	Artikelnr/ NOBB (H)	EFFEKT (W) 45/35/20°C	EFFEKT (W) 55/45/20°C	EFFEKT (W) 60/45/20°C	VOLUM (l)	N- EKSPONENT	VEKT (kg)
	1200	70	8270199		407	711	771	6.6	1.31	26.4
	1400	70	8270201		475	830	900	7.7	1.31	3.5
	1600	70	8270202		543	948	1029	8.8	1.31	34.7
	1800	70	F062105018010300	8270203	611	1067	1157	9.9	1.31	38.9
	2000	70	F062105020010300	8270204	679,678	1185	1285	11.0	1.31	43.9
	2300	70	F062105023010300	8270205	780	1363	1478	12.7	1.31	49.4
	2600	70	8270206		882	1541	1671	14.3	1.31	55.6
	3000	70	8270207		1018	1778	1928	16.5	1.31	64.0
Type 22										
	400	102	8266126		169	299	324	2.2	1.33	11.2
	500	102	F062205005010300	8266127	212	373	405	2.8	1.33	13.7
	600	102	8266128		254	448	486	3.3	1.33	16.4
	700	102	8266129		296	522	567	3.9	1.33	18.6
	800	102	8266131		339	597	648	4.4	1.33	2.9
	900	102	F062205009010300	8266132	381	672	729	5.0	1.33	23.4
	1000	102	8266133		424	746	810	5.5	1.33	25.8
	1100	102	8266134		466	821	891	6.0	1.33	28.3
	1200	102	8266135		508	896	972	6.6	1.33	3.6
	1400	102	F062205014010300	8266136	593	1045	1134	7.7	1.33	35.5
	1600	102	8266137		678	1194	1296	8.8	1.33	4.3
	1800	102	8266138		762	1343	1458	9.9	1.33	45.2
	2000	102	8266139		847	1493	1620	11.0	1.33	5.1
	2300	102	8266141		974	1717	1863	12.7	1.33	57.3
	2600	102	8266142		1101	1940	2106	14.3	1.33	64.6
	3000	102	F062205030010300	8266143	1271	2239	2431,2430	16.5	1.33	74.3

Type 33



500

HØYDE 500 mm	LENGDE	DYBDE	Artikelnr/ NOBB (V)	Artikelnr/ NOBB (H)	EFFEKT (W) 45/35/20°C	EFFEKT (W) 55/45/20°C	EFFEKT (W) 60/45/20°C	VOLUM (l)	N- EKSPONENT	VEKT (kg)
	400	152		8266215	232	411	447	3.3	1.34	16.6
	500	152		8266216	291	514	559	4.1	1.34	2.2
	600	152		8266217	348	617	670	4.9	1.34	23.9
	700	152		8266218	407	719	782	5.7	1.34	27.6
	800	152		8266219	465	822	893	6.6	1.34	31.1
	900	152		8266221	523	925	1005	7.4	1.34	34.8
	1000	152		8266222	581	1028	1116	8.2	1.34	38.5
	1100	152	F063305011010300	8266223	639	1131	1228	9.0	1.34	42.4
	1200	152		8266224	697	1233	1340	9.8	1.34	45.7
	1400	152		8266225	813	1439	1563	11.5	1.34	52.9
	1600	152		8266226	929	1645	1786	13.1	1.34	6.2
	1800	152		8266227	1045	1850	2010	14.8	1.34	67.5
	2000	152		8266228	1162	2056	2233	16.4	1.34	74.7
	2300	152		8266229	1336	2364	2568	18.9	1.34	85.6
	2600	152		8266231	1510	2672	2903	21.3	1.34	96.6
	3000	152		8266232	1742	3084	3349	24.6	1.34	111.9



550

HØYDE 550 mm	LENGDE	DYBDE	Artikelnr/ NOBB	EFFEKT (W) 45/35/20°C	EFFEKT (W) 55/45/20°C	EFFEKT (W) 60/45/20°C	VOLUM (l)	N- EKSPONENT	VEKT (kg)
Type 11									
	1200	60	F061105512010300	332	580	629	3.6	1.31	19.1
	1800	60	F061105518010300	498	871	944	5.4	1.31	28.0
	3000	60	F061105530010300	830	1451	1573	9.0	1.31	45.7
Type 21									
	700	70	F062105507010300	255	447	484	4.3	1.31	17.7
	3000	70	F062105530010300	1093	1915	2076	18.3	1.31	74.9
Type 22									
	800	102	F062205508010300	365	645	700	4.9	1.33	23.2
	1800	102	F062205518010300	822	1451	1575	11.0	1.33	5.8
	3000	102	F062205530010300	1370	2418	2625	18.3	1.33	83.9
Type 33									
	700	152	F063305507010300	437	775	841	6.3	1.34	3.1
	1800	152	F063305518010300	1123	1992	2164	16.2	1.34	74.8



600

HØYDE 600 mm	LENGDE	DYBDE	Artikelnr/ NOBB (V)	Artikelnr/ NOBB (H)	EFFEKT (W) 45/35/20°C	EFFEKT (W) 55/45/20°C	EFFEKT (W) 60/45/20°C	VOLUM (l)	N- EKSPONENT	VEKT (kg)
Type 11										
400	60		8270087		119	208	226	1.3	1.31	7.9
500	60	F061106005010300	8270088		149	260	282	1.6	1.31	9.5
600	60	F061106006010300	8270089		179	313	339	1.9	1.31	11.1
700	60		8270091		208	365	396	2.2	1.31	12.7
800	60	F061106008010300	8270092		238	417	452	2.6	1.31	14.4
900	60		8270093		268	469	508	2.9	1.31	16.0
1000	60		8270094		298	521	565	3.2	1.31	17.6
1100	60	F061106011010300	8270095		327	573	622,621	3.5	1.31	19.2
1200	60		8270096		357	625	678	3.8	1.31	20.9
1400	60		8270097		417	729	791	4.5	1.31	24.4
1600	60		8270098		476	834	904	5.1	1.31	27.3
1800	60		8270099		536	938	1017	5.8	1.31	30.5
2000	60		8270101		595	1042	1130	6.4	1.31	33.7
2300	60		8270102		684	1198	1299	7.4	1.31	38.6
2600	60	F061106026010300	8270103		774	1354	1469	8.3	1.31	43.4
3000	60		8270104		893	1563	1695	9.6	1.31	49.8
Type 21										
400	70		8270214		155	273	296	2.6	1.32	11.5
500	70		8270215		194	341	370	3.3	1.32	14.4
600	70		8270216		233	409	444	4.0	1.32	16.6
700	70		8270217		272	478	518	4.6	1.32	19.2
800	70		8270218		311	546	592	5.3	1.32	21.7
900	70		8270219		349	614	666	5.9	1.32	24.3
1000	70		8270221		388	682	740	6.6	1.32	26.8
1100	70		8270222		427	751	814	7.3	1.32	29.4



600

HØYDE 600 mm	LENGDE	DYBDE	Artikelnr/ NOBB (V)	Artikelnr/ NOBB (H)	EFFEKT (W) 45/35/20°C	EFFEKT (W) 55/45/20°C	EFFEKT (W) 60/45/20°C	VOLUM (l)	N- EKSPONENT	VEKT (kg)
	1200	70	8270223		466	819	889	7.9	1.32	31.9
	1400	70	8270224		543	955	1037	9.2	1.32	37.3
	1600	70	8270225		621	1092	1185	10.6	1.32	42.1
	1800	70	8270226		699	1228	1333	11.9	1.32	47.2
	2000	70	8270227		776	1365	1481	13.2	1.32	52.3
	2300	70	8270228		893	1569	1703	15.2	1.32	60.0
	2600	70	8270229		1009	1774	1925	17.2	1.32	67.6
	3000	70	8270231		1164	2047	2221	19.8	1.32	77.8
Type 22										
	400	102	8270325		195	346	375	2.6	1.34	13.8
	500	102	8270326		244	432	469	3.3	1.34	16.8
	600	102	8270327		293	518	563	4.0	1.34	19.6
	700	102	F062206007010300	8270328	342	605	657	4.6	1.34	22.6
	800	102	8270329		391	691	750	5.3	1.34	25.5
	900	102	8270331		440	777	844	5.9	1.34	28.4
	1000	102	8270332		488	864	938	6.6	1.34	31.4
	1100	102	8270333		537	950	1032	7.3	1.34	34.3
	1200	102	8270334		586	1037	1126	7.9	1.34	37.2
	1400	102	8270335		684	1209	1314	9.2	1.34	43.9
	1600	102	8270336		781	1382	1501	10.6	1.34	49.0
	1800	102	8270337		879	1555	1689	11.9	1.34	54.9
	2000	102	8270338		977	1728	1876	13.2	1.34	67
	2300	102	8270339		1123	1987	2158	15.2	1.34	69.5
	2600	102	8270341		1270	2246	2439	17.2	1.34	78.3
	3000	102	8270342		1465	2591	2815	19.8	1.34	90.0

Type 33



600

HØYDE 600 mm	LENGDE	DYBDE	Artikelnr/ NOBB (V)	Artikelnr/ NOBB (H)	EFFEKT (W) 45/35/20°C	EFFEKT (W) 55/45/20°C	EFFEKT (W) 60/45/20°C	VOLUM (l)	N- EKSPONENT	VEKT (kg)
	400	152		8266233	266	473	514	3.9	1.35	2.8
	500	152	F063306005010300	8266234	333	592	643	4.9	1.35	24.5
	600	152		8266235	399	710	772	5.9	1.35	28.9
	700	152		8266236	466	828	900	6.9	1.35	33.3
	800	152		8266237	532	946	1029	7.8	1.35	37.6
	900	152		8266238	599	1065	1157	8.8	1.35	42.2
	1000	152	F063306010010300	8266239	665	1183	1286	9.8	1.35	46.4
	1100	152		8266241	732	1301	1415	10.8	1.35	5.9
	1200	152		8266242	798	1420	1543	11.8	1.35	55.2
	1400	152		8266243	931	1656	1800	13.7	1.35	64.0
	1600	152	F063306016010300	8266244	1065,1064	1893	2058,2057	15.7	1.35	72.8
	1800	152		8266245	1197	2129	2315	17.6	1.35	81.5
	2000	152		8266246	1330	2366	2572	19.6	1.35	9.4
	2300	152		8266247	1530	2721	2958	22.5	1.35	105.5
	2600	152		8266248	1730	3076	3344	25.5	1.35	116.7
	3000	152		8266249	1996	3549	3858	29.4	1.35	134.3



900

HØYDE 900 mm	LENGDE	DYBDE	Artikelnr/ NOBB (V)	Artikelnr/ NOBB (H)	EFFEKT (W) 45/35/20°C	EFFEKT (W) 55/45/20°C	EFFEKT (W) 60/45/20°C	VOLUM (l)	N- EKSPONENT	VEKT (kg)
Type 11										
400	60		F061109004010300	8270107	166	291	316	1.8	1.32	11.9
500	60			8270108	208	364	395	2.3	1.32	14.3
600	60			8270109	249	437	474	2.7	1.32	16.8
700	60			8270111	291	510	553	3.1	1.32	19.2
800	60			8270112	332	583	632	3.6	1.32	21.7
900	60			8270113	373	655	711	4.0	1.32	24.2
1000	60			8270114	415	728	790	4.5	1.32	26.7
1100	60			8270115	457	801	869	5.0	1.32	29.2
1200	60		F061109012010300	8270116	498	874	948	5.4	1.32	31.6
1400	60			8270117	581	1019	1106	6.3	1.32	36.6
1600	60		F061109016010300	8270118	664	1165	1264	7.2	1.32	41.6
1800	60			8270119	747	1311	1422	8.1	1.32	46.5
2000	60			8270121	830	1456	1580	9.0	1.32	51.5
2300	60			8270122	955	1675	1817	10.3	1.32	58.9
2600	60			8270123	1079	1893	2054	11.7	1.32	66.4
3000	60			8270124	1245	2185	2370	13.5	1.32	76.3
Type 21										
400	70			8266091	212	376	408	3.6	1.34	16.7
500	70		F062109005010300	8266092	265	470	510	4.5	1.34	2.6
600	70			8266093	318	563	612	5.4	1.34	24.3
700	70			8266094	371	657	714	6.3	1.34	28.6
800	70			8266095	424	751	816	7.2	1.34	31.8
900	70			8266096	477	845	918	8.1	1.34	35.6
1000	70			8266097	530	939	1020	9.0	1.34	39.5
1100	70			8266098	583	1033	1122	9.9	1.34	43.2



900

HØYDE 900 mm	LENGDE	DYBDE	Artikelnr/ NOBB (V)	Artikelnr/ NOBB (H)	EFFEKT (W) 45/35/20°C	EFFEKT (W) 55/45/20°C	EFFEKT (W) 60/45/20°C	VOLUM (l)	N- EKSPONENT	VEKT (kg)
1200	70		8266099		636	1127	1224	10.8	1.34	47.0
1400	70		8266101		742	1315	1428	12.6	1.34	54.5
1600	70		F062109016010300	8266102	849,848	1502	1632	14.4	1.34	62.8
1800	70		8266103		954	1690	1836	16.2	1.34	69.6
2000	70		8266104		1060	1878	2040	18.0	1.34	77.2
2300	70		8266105		1219	2160	2346	20.7	1.34	88.5
2600	70		8266106		1379	2442	2653	23.4	1.34	101.8
3000	70		8266107		1591	2817	3060	27.0	1.34	115.0
Type 22										
400	102		8266144		268	478	520	3.6	1.36	19.8
500	102		8266145		335	597	650	4.5	1.36	24.2
600	102		8266146		402	717	780	5.4	1.36	28.7
700	102		8266147		469	836	910	6.3	1.36	33.2
800	102		F062209008010300	8266148	536	956	1039	7.2	1.36	37.7
900	102		8266149		603	1075	1169	8.1	1.36	42.2
1000	102		8266151		670	1194	1299	9.0	1.36	46.7
1100	102		8266152		737	1314	1429	9.9	1.36	51.2
1200	102		8266153		804	1433	1559	10.8	1.36	55.7
1400	102		8266154		937	1672	1819	12.6	1.36	64.7
1600	102		8266155		1071	1911	2079	14.4	1.36	73.7
1800	102		8266156		1205	2150	2338	16.2	1.36	82.7
2000	102		8266157		1339	2389	2598	18.0	1.36	91.6
2300	102		8266158		1540	2747	2988	20.7	1.36	107.2
2600	102		8266159		1741	3106	3378	23.4	1.36	118.7
3000	102		F062209030010300	8266161	2009	3583	3897,3896	27.0	1.36	136.6

Type 33



900

HØYDE 900 mm	LENGDE	DYBDE	Artikelnr/ NOBB (V)	Artikelnr/ NOBB (H)	EFFEKT (W) 45/35/20°C	EFFEKT (W) 55/45/20°C	EFFEKT (W) 60/45/20°C	VOLUM (l)	N- EKSPONENT	VEKT (kg)
	400	152		8266251	364	651	708	5.3	1.36	28.7
	500	152	F063309005010300	8266252	455	814	885	6.7	1.36	35.4
	600	152		8266253	546	976	1062	8.0	1.36	42.9
	700	152		8266254	637	1139	1239	9.3	1.36	48.8
	800	152		8266255	729	1302	1416	10.6	1.36	55.5
	900	152	F063309009010300	8266256	820	1465	1593	12.0	1.36	62.3
	1000	152	F063309010010300	8266257	911	1627	1770	13.3	1.36	69.0
	1100	152	F063309011010300	8266258	1002	1790	1947	14.6	1.36	75.6
	1200	152		8266259	1093	1953	2124	16.0	1.36	82.3
	1400	152		8266261	1275	2278	2478	18.6	1.36	95.7
	1600	152	F063309016010300	8266262	1457	2604	2832	21.3	1.36	111.3
	1800	152		8266263	1639	2929	3187	23.9	1.36	122.6
	2000	152		8266264	1821	3255	3541	26.6	1.36	136.0
	2300	152		8266265	2095	3743	4072	30.6	1.36	156.8
	2600	152		8266266	2368	4231	4603	34.6	1.36	176.2
	3000	152	F063309030010300	8266267	2733,2732	4882	5311,5310	39.9	1.36	207.0