



Technische fiche

2026-04-26

# Paros V

Zachte, ronde vorm



- ✓ Modern afgerond ontwerp
- ✓ Perfecte oplossing voor beperkte wandruimte
- ✓ Handdoekrek van hoogwaardig roestvrij staal
- ✓ Middenaansluiting radiator
- ✓ Draaibaar voor aansluiting van bovenaf

**Paros V** is ontworpen om bij elke decoratiestijl te passen, of je nu de voorkeur geeft aan een romantische, klassieke stijl of een strakker, modern ontwerp. Deze verticale paneelradiator is standaard verkrijgbaar in RAL 9016 wit, maar er is een brede waaier aan speciale kleuren optioneel verkrijgbaar. Een handdoekhouder in roestvrijstaal van hoge kwaliteit is verkrijgbaar als accessoire. De zijafdekkingen zijn geïntegreerd met een decoratieve voorplaat in één elegante afgeronde behuizing die verlijmd is met het centrale verwarmingslichaam. Compleet met ophangbeugels inclusief set schroeven en pluggen met montagehandleiding, 3 messing blindstoppen en ontluchter.



### **Toepassingsgebied**

Tekst: Hedendaags alternatief voor horizontale radiatoren, vervaardigd uit staal. Fabrieksmatig uitgerust met een slanke platte stalen plaat, zijpanelen en bovenrooster. Verkrijgbaar in verschillende maten en de perfecte oplossing voor toepassingen met beperkte muurruimte. 2-pijps indirecte huishoudelijke en commerciële verwarmingssystemen. 6 x 1/2" BSP aansluitingen.

### **Selectiecriteria**

Gebruik een warmtebehoefte Calculator om te bepalen welk warmtevermogen nodig is uit het grote assortiment van Paros V verticale radiatoren.

### **Gebruik**

Luchtventiel en pluggpakketten zijn inbegrepen in de verpakking. thermostaatknop kunnen worden geïnstalleerd om de kamertemperatuur te regelen.

### **Bestektekst**

Tekst: Designer radiator Paros V, ontworpen als een verticale radiator met een vlakke voorzijde geïntegreerd met afgeronde zijafdekkingen zonder naden, verkrijgbaar als type 11 met één verwarmingspaneel en één laag convectielamellen of als type 21 met twee verwarmingspanelen en één laag convectielamellen



# Specificaties

EIGENSCHAPPEN	EENHEID	WAARDEN
ETIM klasse		ECO11022
Materiaal		Staal
Type		11, 21
Oppervlaktestructuur		Vlak glad
Max. werkdruk	bar	10
Aantal standaard aansluitingen		4
Thermisch vermogen volgens EN 442		Ja
Max. Bedrijfstemperatuur	°C	110
Standaard kleur		Ja
Kleur		Wit
RAL-nummer		9016
Zijrooster		Ja
Bovenrooster		Ja
Glansgraad		Glanzend
Draadmaat		1/2"
Schroefdraadverbinding		Binnendraad
Met eenpuntsaansluiting		Ja
Met ontluichtingsaansluiting		Ja
Met ontluchter		Ja
Met aftapmogelijkheid		Ja



# Documenten

DOCUMENTEN	TYPE DOCUMENT	LINK
MCW-V console montagehandleiding	User	<a href="https://asset.productmarketingcloud.com/api/assetstorage/3577_11eef8e5-d09b-4fa6-801c-c9f3a5e54ab8">https://asset.productmarketingcloud.com/api/assetstorage/3577_11eef8e5-d09b-4fa6-801c-c9f3a5e54ab8</a>
Tinos & Paros handdoekrail handleiding	Installation	<a href="https://asset.productmarketingcloud.com/api/assetstorage/3577_6c26c8b8-751e-4206-a79a-1c7b185c9e31">https://asset.productmarketingcloud.com/api/assetstorage/3577_6c26c8b8-751e-4206-a79a-1c7b185c9e31</a>
Tinos V & Paros V montagehandleiding	Installation	<a href="https://asset.productmarketingcloud.com/api/assetstorage/3577_eb54ebff-acac-48f6-a65f-d044ed1a40d6">https://asset.productmarketingcloud.com/api/assetstorage/3577_eb54ebff-acac-48f6-a65f-d044ed1a40d6</a>
Calculator designradiatoren	TechDia	<a href="https://asset.productmarketingcloud.com/api/assetstorage/3577_6a68539c-c460-4642-8d8b-056f68b79286">https://asset.productmarketingcloud.com/api/assetstorage/3577_6a68539c-c460-4642-8d8b-056f68b79286</a>



# Bronnen

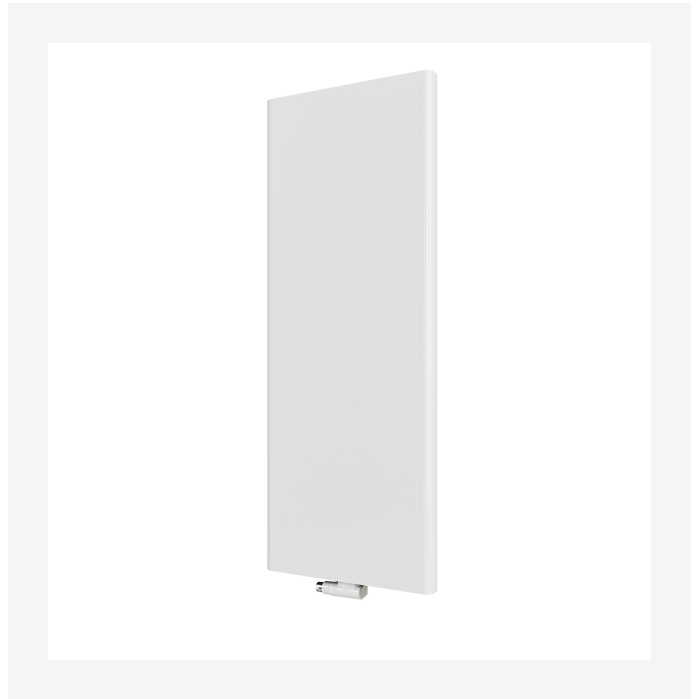

ProductImage - New\_Paros-V-Towel-warmer product image

ProductImage - New\_Paros-V main picture

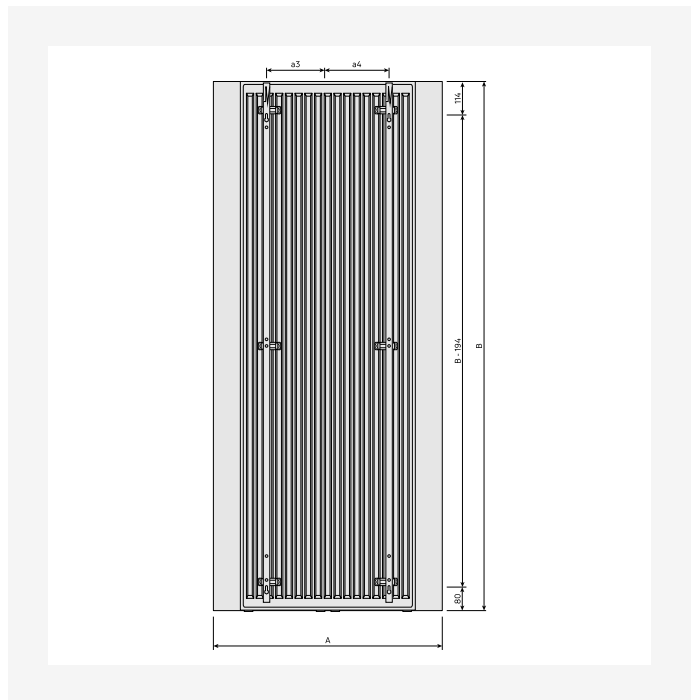
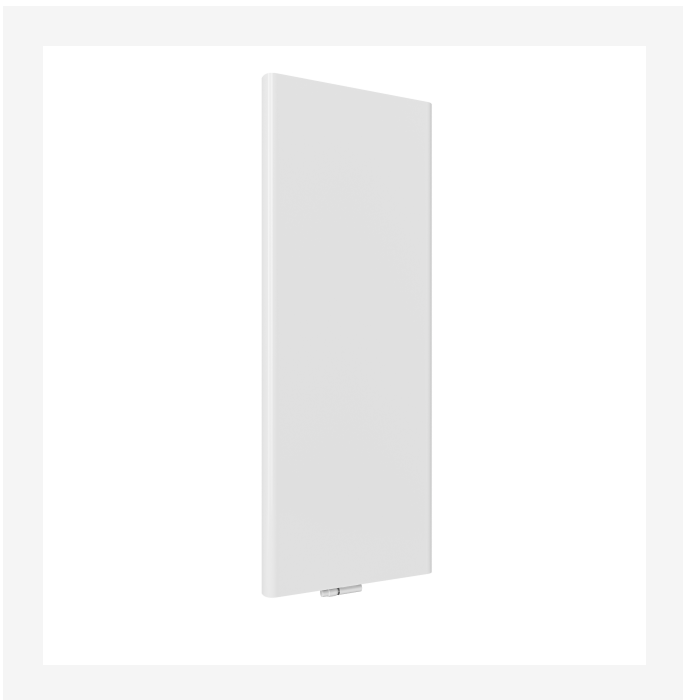

ProductImage - New\_Paros-V product image

DimensionalDrawing - New\_Paros V rear view



# Bronnen

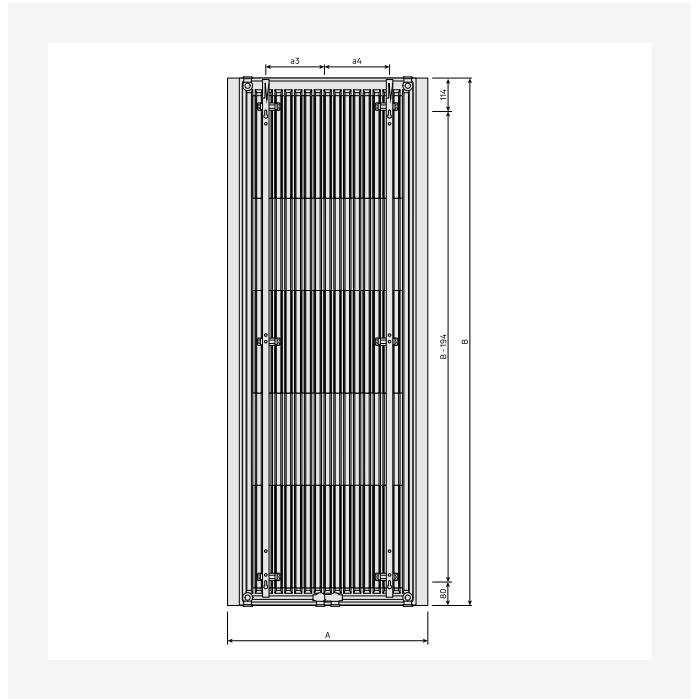
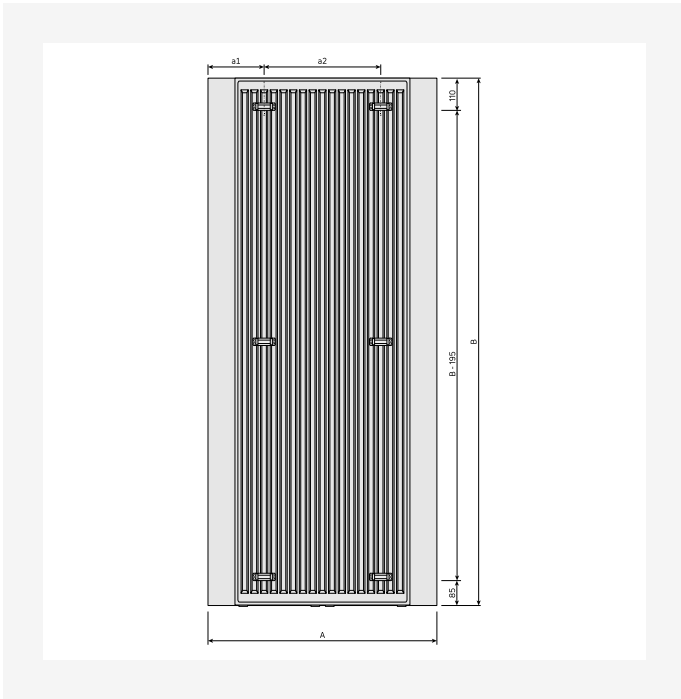

DimensionalDrawing - New\_Paros V rear view

DimensionalDrawing - New\_Paros V rear view

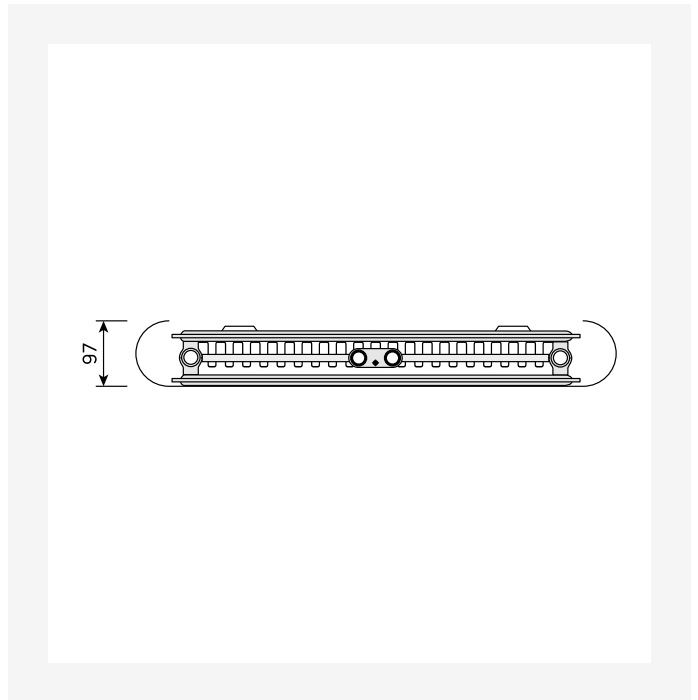
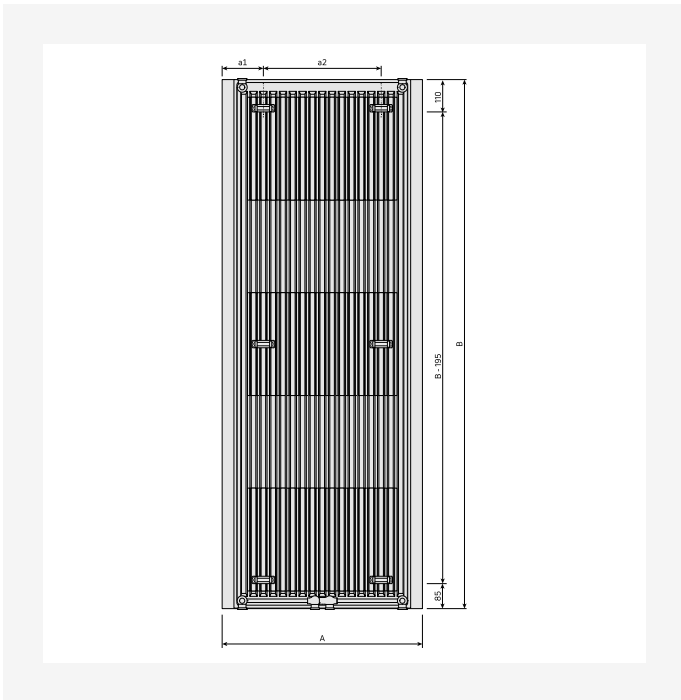

DimensionalDrawing - New\_Paros V rear view

DimensionalDrawing - New\_Paros V top view



# Bronnen

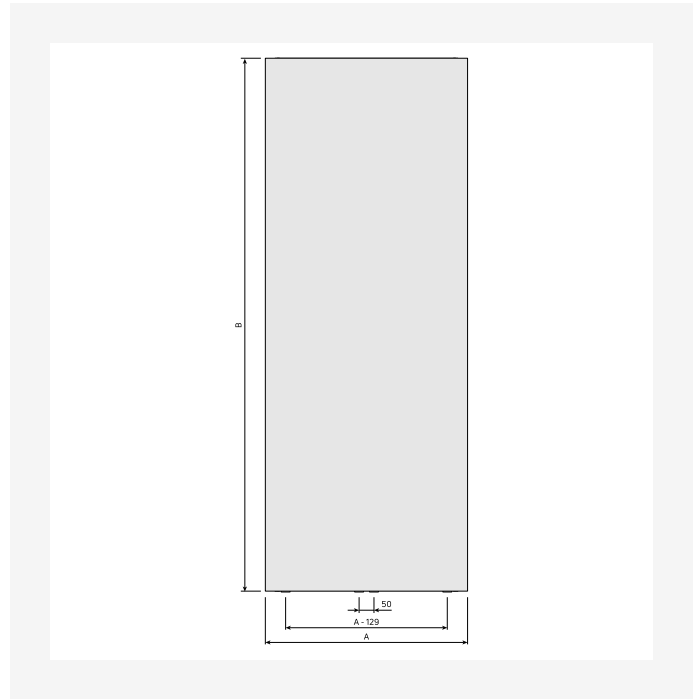
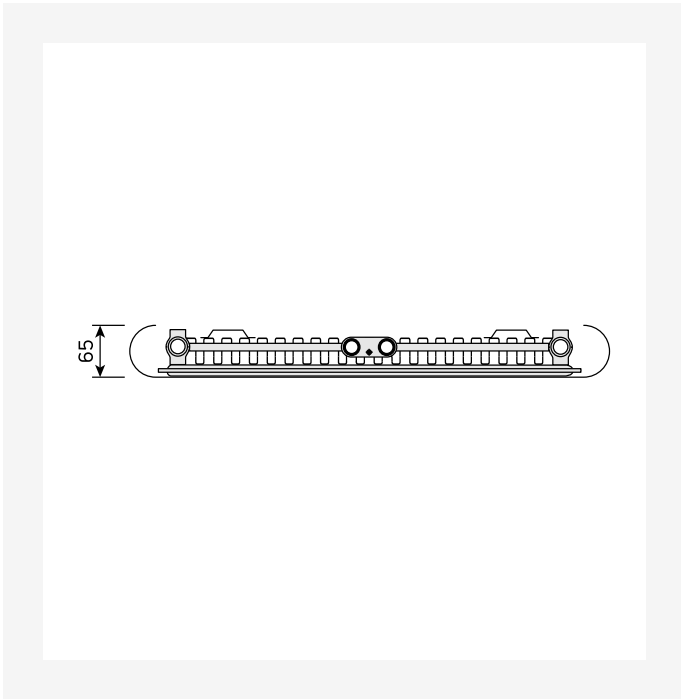

DimensionalDrawing - New\_Paros V top view

DimensionalDrawing - New\_Paros V front view

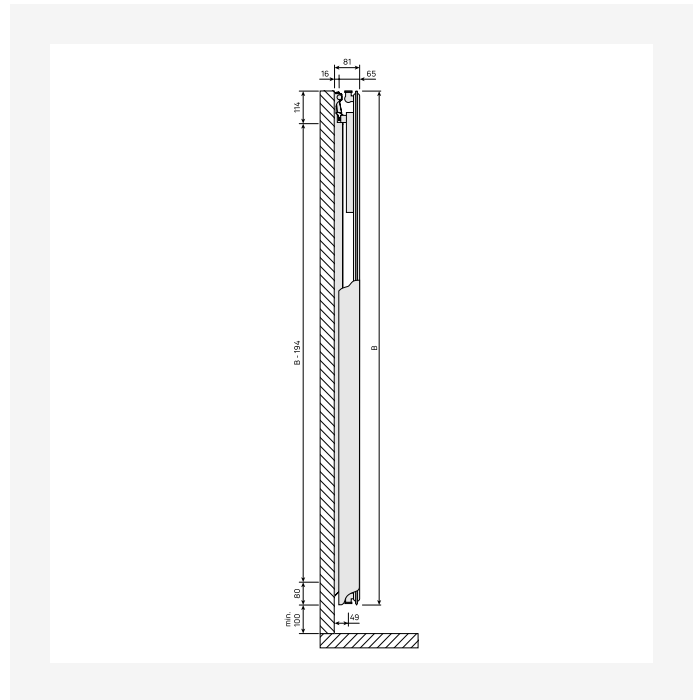
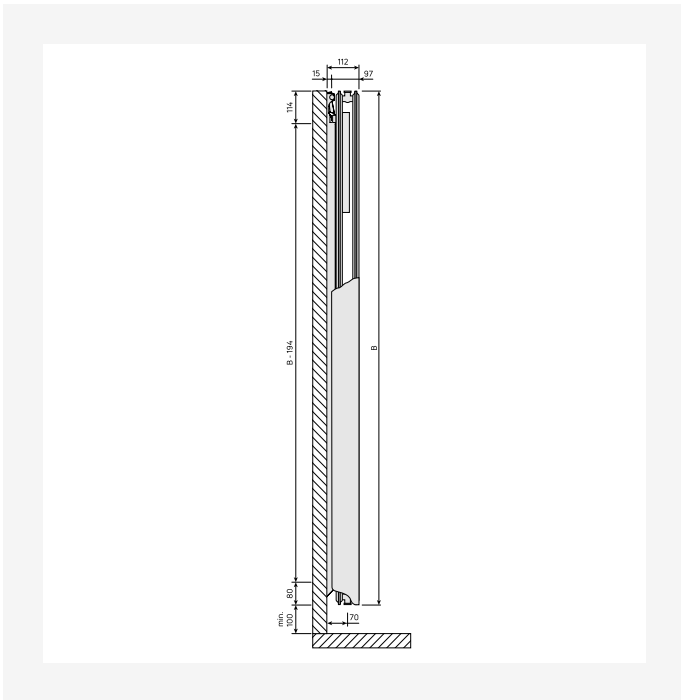

DimensionalDrawing - New\_Tinos V-Paros V side view

DimensionalDrawing - New\_Tinos V-Paros V side view





# Bronnen

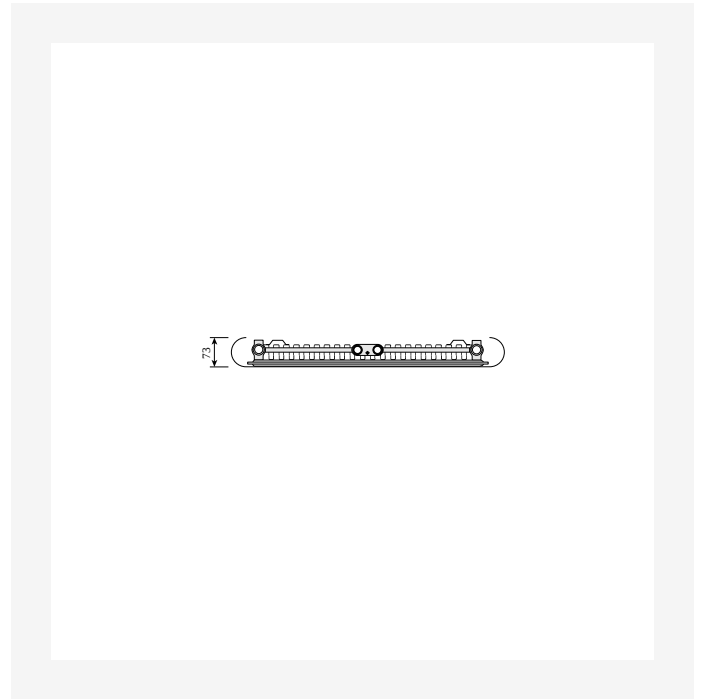
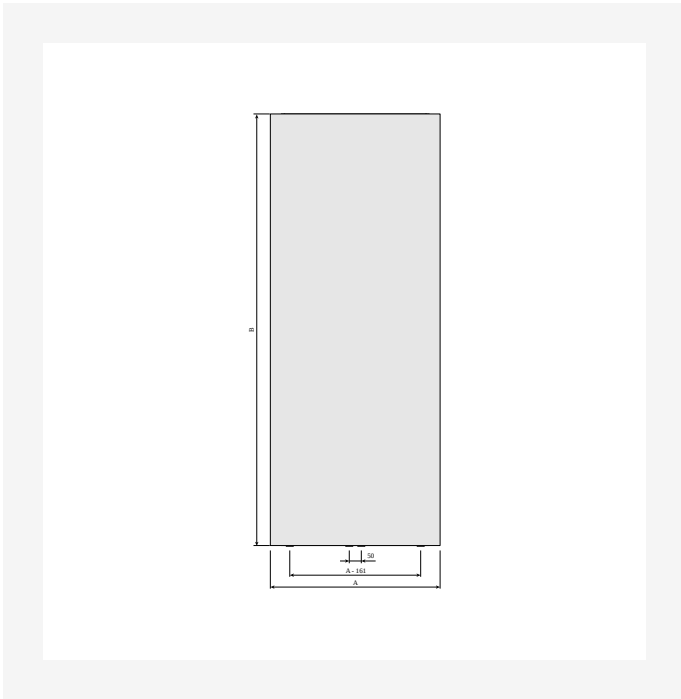

DimensionalDrawing - Paros V, type 21, front view

DimensionalDrawing - Paros V, type 11, top view

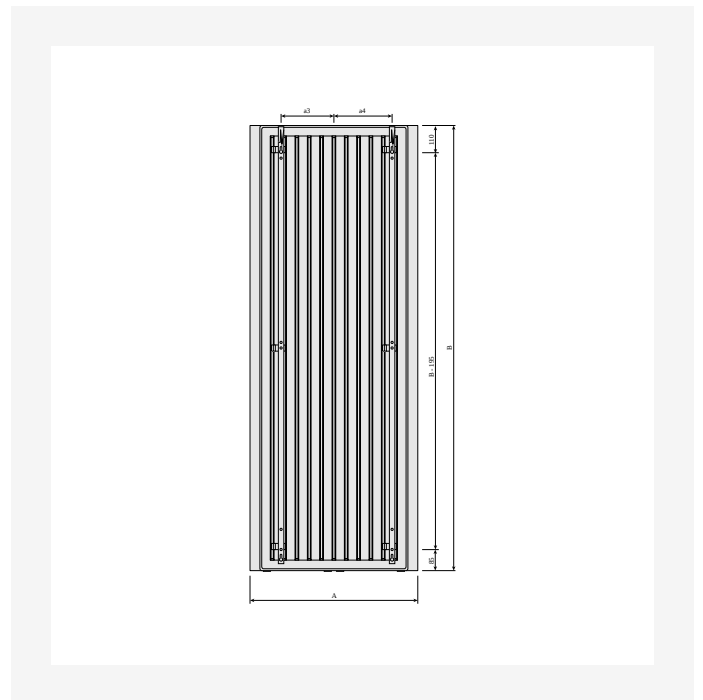
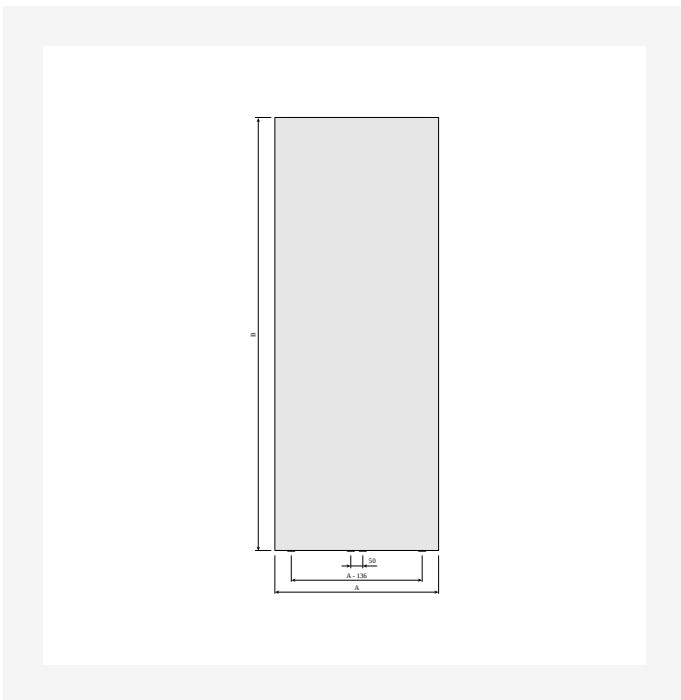

DimensionalDrawing - Paros V, type 11, front view

DimensionalDrawing - Paros V, back view with MCW V brackets



# Bronnen

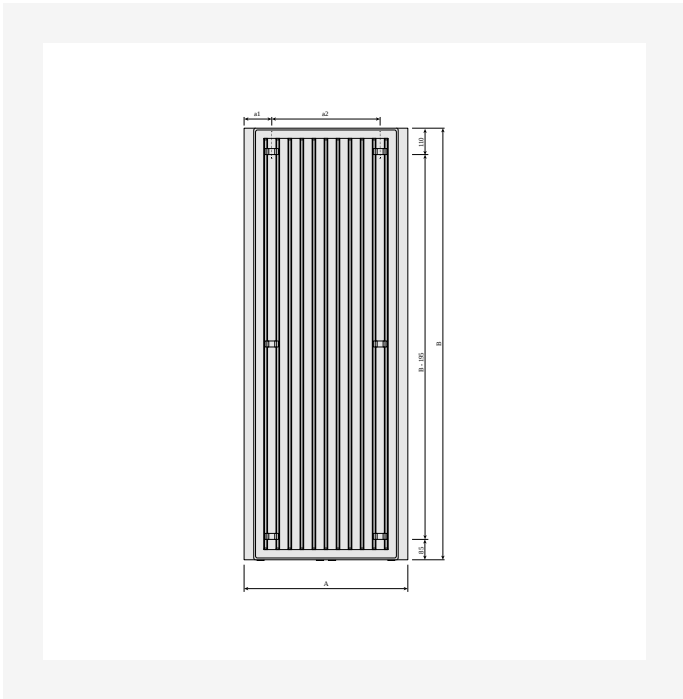

DimensionalDrawing - Paros V, back view



# Gerelateerde producten





# 1800

HOOGTE 1800 mm	LENGTE	DIEPTE	ARTIKELCODE	Regime (W) 45/35/20°C	Regime (W) 75/65/20°C	VOLUME (l)	N- EXPONENT	GEWICHT (kg)
<b>Type 11</b>								
	373	65	PAVP111800380	365	720	2.6	1.26	21.0
	523	65	PAVP111800530	524	1042	3.8	1.26	29.6
	673	65	PAVP111800680	678	1355	4.9	1.27	38.1
<b>Type 21</b>								
	405	97	PAVP211800405	449	955	4.8	1.29	32.3
	555	97	PAVP211800555	637	1389	7.2	1.30	47.7
	705	97	PAVP211800705	810	1812	9.7	1.31	63.1



# 1950

HOOGTE 1950 mm	LENGTE	DIEPTE	ARTIKELCODE	Regime (W) 45/35/20°C	Regime (W) 75/65/20°C	VOLUME (l)	N- EXPONENT	GEWICHT (kg)
<b>Type 11</b>								
	373	65	PAVP111950380	393	767	2.9	1.26	22.5
	523	65	PAVP111950530	560	1110	4.1	1.26	31.6
	673	65	PAVP111950680	717	1444	5.4	1.27	40.8
	823	65	PAVP111950830	865	1770	6.7	1.27	49.9
<b>Type 21</b>								
	405	97	PAVP211950405	470	1008	5.2	1.29	34.8
	555	97	PAVP211950555	674	1466	7.8	1.30	51.3
	705	97	PAVP211950705	868	1913	10.4	1.30	67.9
	855	97	PAVP211950855	1051	2351	13.0	1.31	84.4



# 2100

HOOGTE 2100 mm	LENGTE	DIEPTE	ARTIKELCODE	Regime (W) 45/35/20°C	Regime (W) 75/65/20°C	VOLUME (l)	N- EXPONENT	GEWICHT (kg)
<b>Type 11</b>								
	673	65	PAVP112100680	761	1530	5.8	1.26	43.6
	823	65	PAVP112100830	908	1876	7.3	1.27	53.4
<b>Type 21</b>								
	705	97	PAVP212100705	926	2012	11.1	1.30	72.7
	855	97	PAVP212100855	1135	2473	13.9	1.30	90.4