



Datu lapa

2026-06-07

Plint R

Nodrošina efektīvu apkuri ar elegantu dizainu.



- ✓ Viegla apkope
- ✓ Labs termiskais komforts
- ✓ Elastīga uzstādīšana
- ✓ Izturīga un uzticama konstrukcija
- ✓ Mūsdienīgs dizains

Plint R paneļu radiators ar gludu priekšējo virsmu un viegliem horizontāliem reljefiem nodrošina estētisku un efektīvu apkures risinājumu. Piemērots sienas vai grīdas montāžai, ar termostatisko vārstu un RAL 9016 apdari.



Pielietojuma joma

Plint R radiatori paredzēti telpām ar lielām stiklotām virsmām. Darba spiediens 10 bar, temperatūra 110°C. Pieslēgumi: 6 porti. Augstums 200 mm, garums 600–3000 mm.

Dimensiju noteikšana

Lai nodrošinātu pareizu produktu izvēli, lūdzu, izmantojiet mūsu kalkulatoru rīkus un produktu bukletus. Ja nepieciešama palīdzība, sazinieties ar mūsu pārdošanas komandu.

Lietošana

Lai nodrošinātu optimālu veiktspēju, Plint R radiatoru uzstādi ar sienas kronšteiniem vai grīdas statīviem

atbilstoši telpas prasībām, pieslēdz visus sešus pieslēguma portus (4 sānu un 2 apakšējos) un nepārsniedz maksimālo spiedienu un temperatūru, regulārā apkope ietver priekšējā paneļa tīrīšanu efektivitātes un izskata saglabāšanai.

AMA teksts

Plint R plākšņu radiators paredzēts ūdens apkures sistēmām. Pieslēgums no apakšas vai pēc vārsta ieliktna demontāžas — no sāna. Radiatoram ir gluda priekšējā plate ar vieglām horizontālām reljefa līnijām. Divi 1/2" apakšējie pieslēgumi nodrošina diskretu instalācijas izvietojumu. Aprīkots ar termostatisko vārstu ar priekšiestatījumu. Standarta krāsa RAL 9016, citi toņi pieejami pēc pieprasījuma. Garantija 10 gadi.



Specifikācijas

ĪPAŠĪBAS	VIENĪBA	VĒRTĪBAS
ETIM klase		EC011022
Materiāls		Tērauds
Tips		21, 22, 33, 44
Virsmas struktūra		Līdzens gluds
Maks. darba spiediens	bar	10
Standarta pieslēgumu skaits		2
Siltuma atdeve pēc EN 442 atzītas laboratorijas		Jā
Maksimālā darbības temperatūra	°C	110
Standarta krāsa		Jā
Krāsa		Balts
RAL numurs		9016
Restes/Vāka plāksne		Jā
Restes/Vāka plāksne		Jā
Spīduma vērtība		Spīdīgs
Vītnes izmērs (collas)		1/2 inch
Pieslēguma vītne		Iekšējā vītne
Ar vienpunkta pieslēgumu		Jā
Ar ventilācijas pieslēgumu		Jā
Ar ventilācijas vārstu/gaisa atgaisotāju		Jā
Ar iztukšošanas iespēju		Jā



Resursi



ProductImage - Panel radiator Plint R, 200 mm.

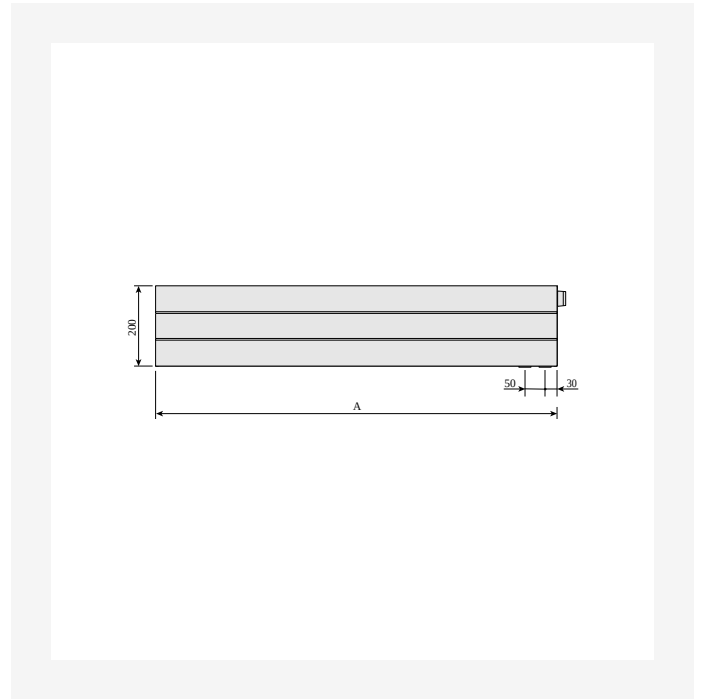

DimensionalDrawing - Plint R un Plint RD, skats no priekšpuses

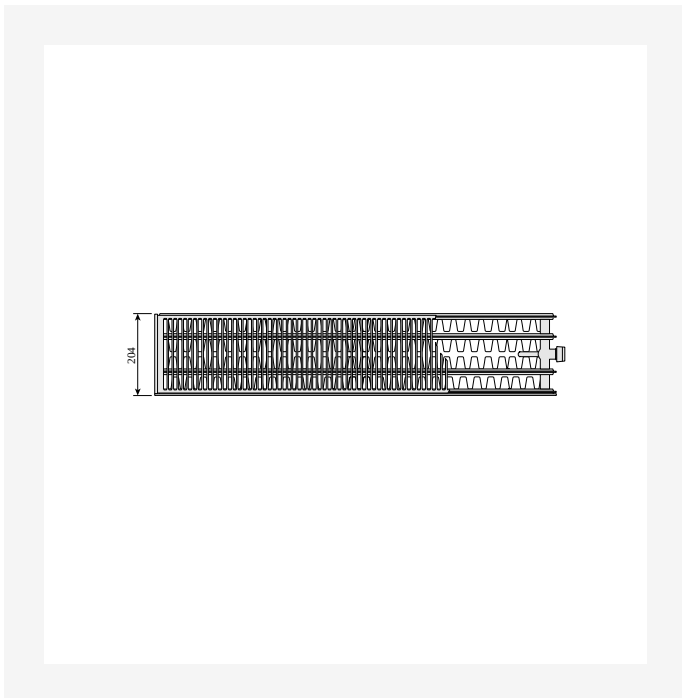

DimensionalDrawing - Plint P un Plint R, tips 44, skats no augšas

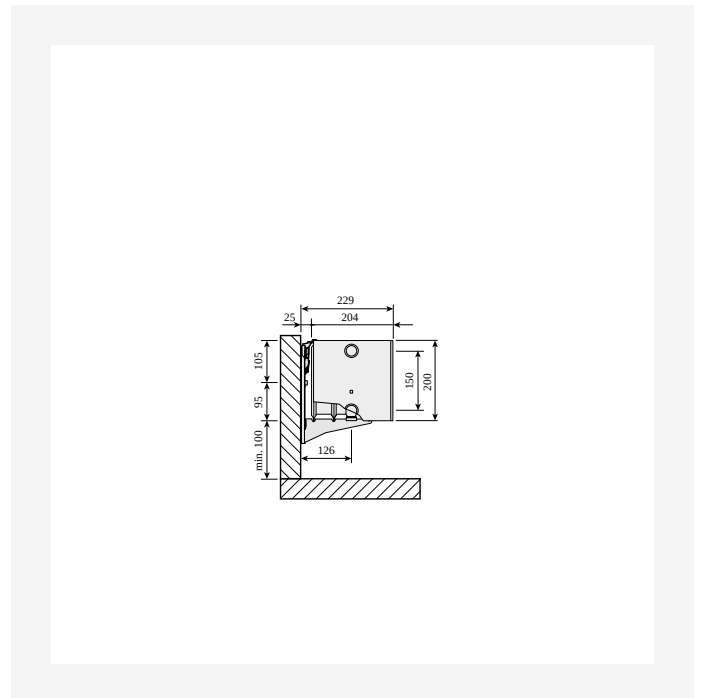

DimensionalDrawing - Plint P un Plint R, tips 44, skats no sāniem ar Monclac sienas kronšteinu



Resursi

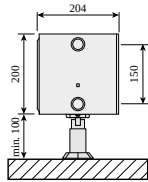

DimensionalDrawing - Plint P un Plint R, tips 44, ar grīdas kronšteinu, skats no sāniem

DimensionalDrawing - Plint P un Plint R, tips 33, skats no augšas

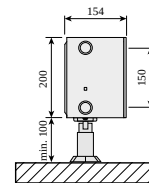
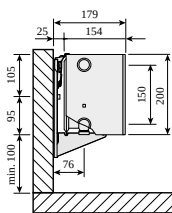

DimensionalDrawing - Plint P un Plint R, tips 33, skats no sāniem ar Monclac sienas kronšteinu

DimensionalDrawing - Plint P un Plint R, tips 33, ar grīdas kronšteinu, skats no sāniem



Resursi

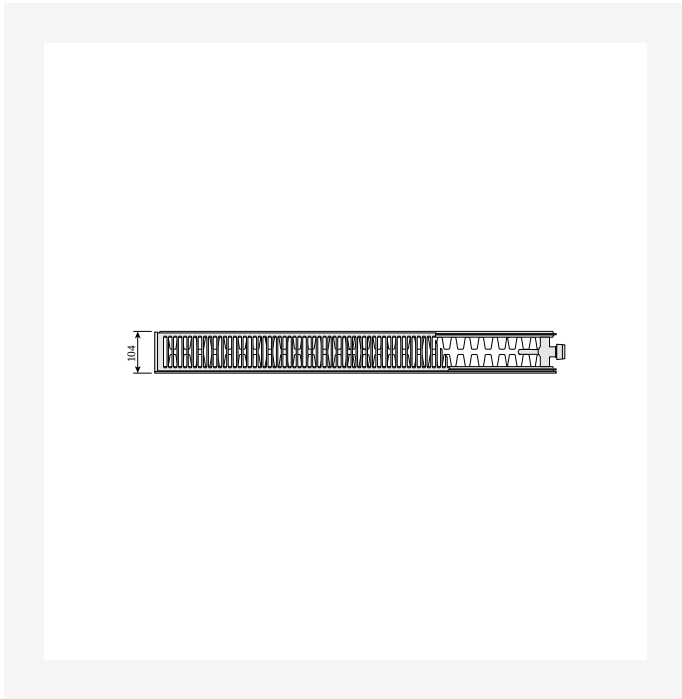

DimensionalDrawing - Plint P un Plint R, tips 22, skats no augšas

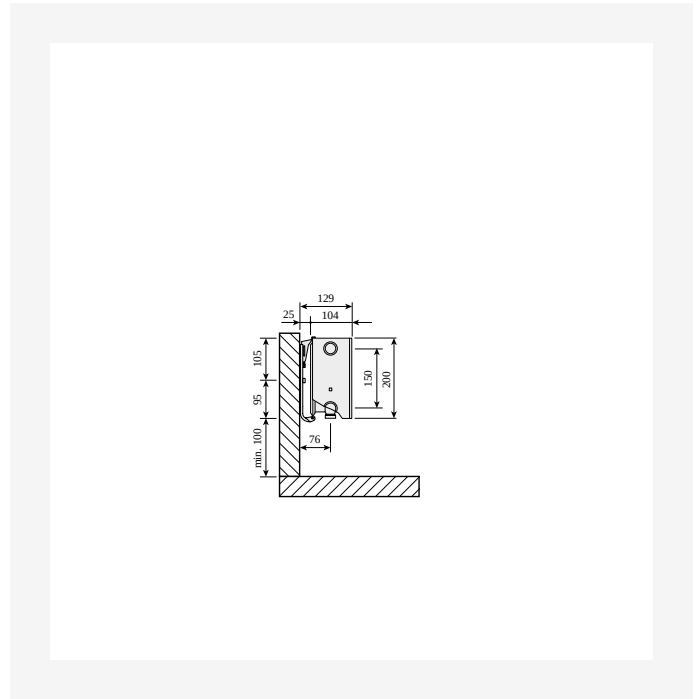

DimensionalDrawing - Plint P un Plint R, tips 22, skats no sāniem ar Monclac sienas kronšteiniem

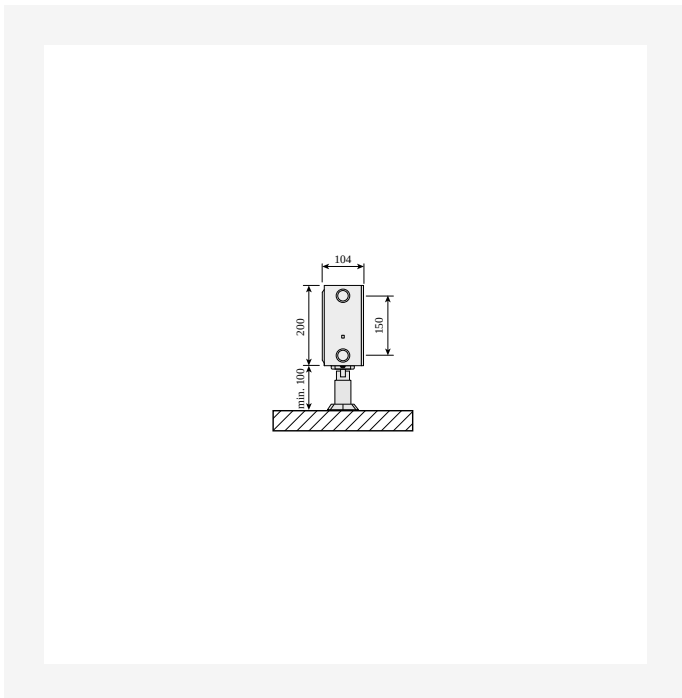

DimensionalDrawing - Plint P un Plint R, tips 22, ar grīdas kronšteiniem, skats no sāniem

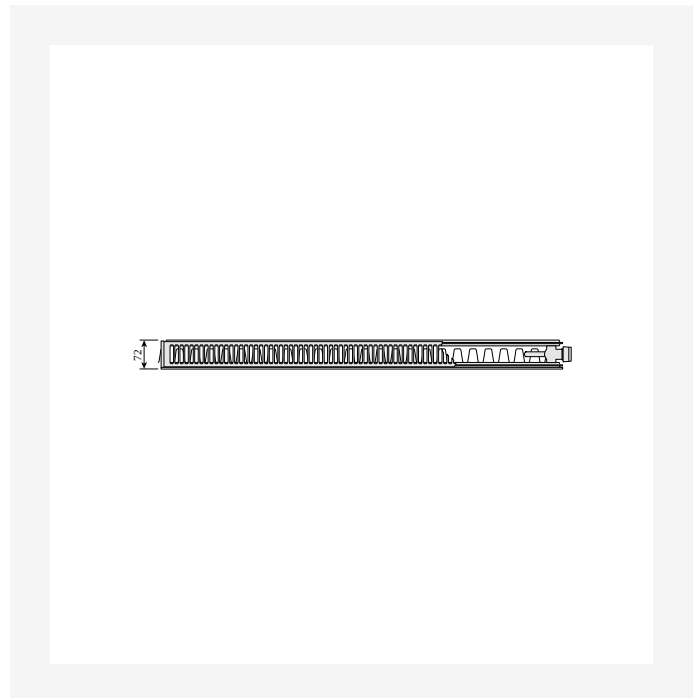

DimensionalDrawing - Plint P un Plint R, tips 21s, skats no augšas



Resursi

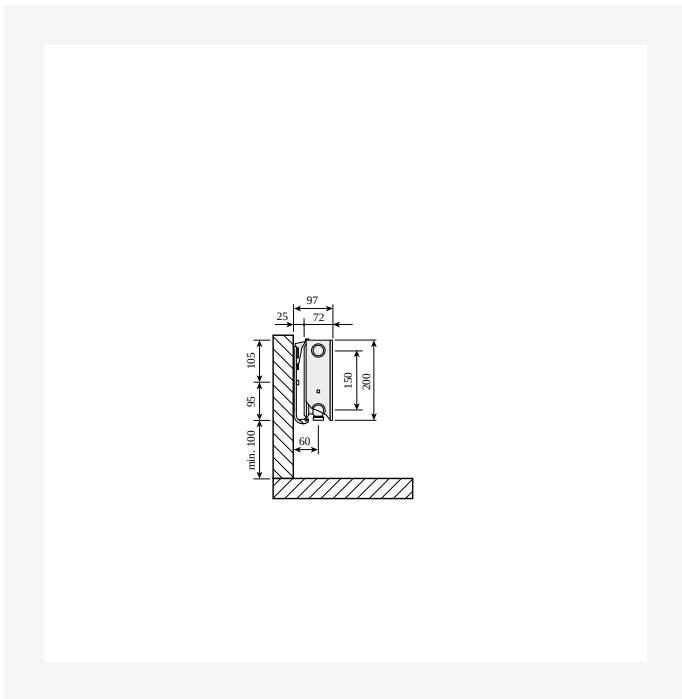

DimensionalDrawing - Plint P un Plint R, tips 21s, skats no sāniem ar Monclac sienas kronšteiniem

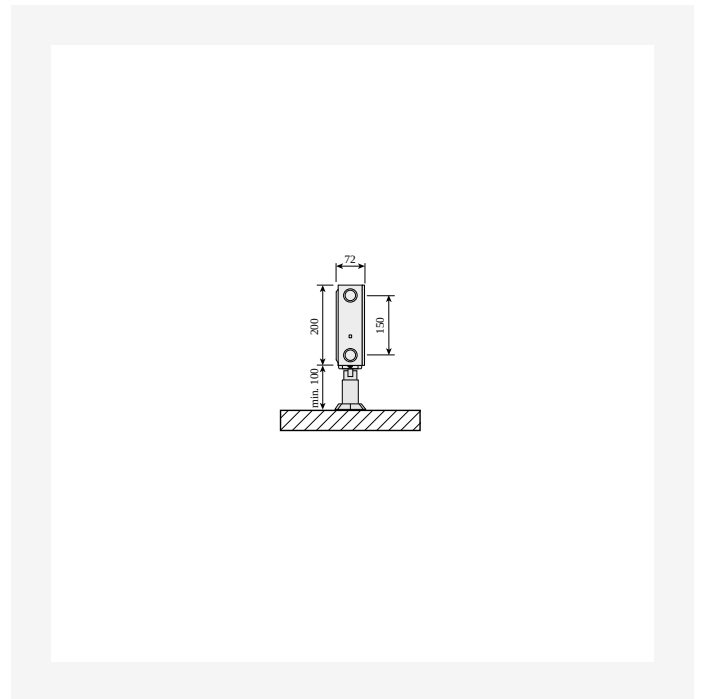

DimensionalDrawing - Plint P un Plint R, tips 21s, ar grīdas kronšteiniem, skats no sāniem

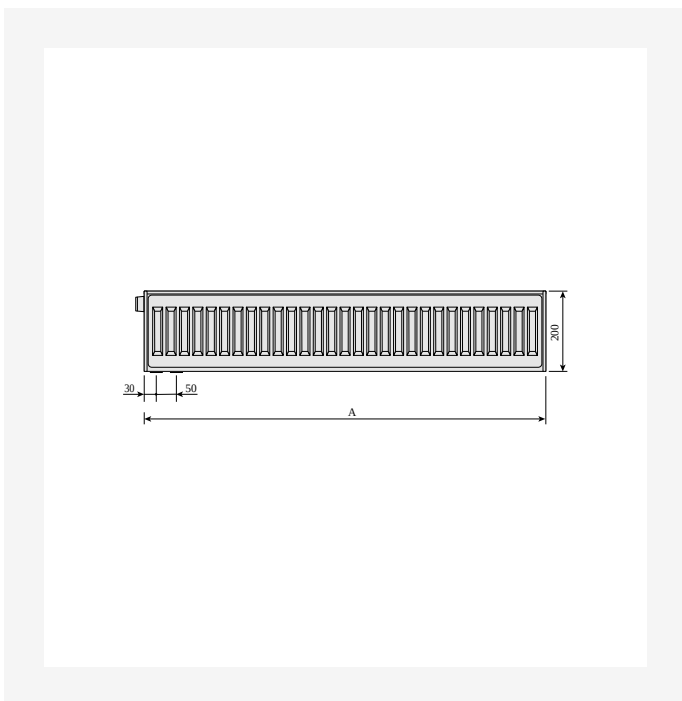

DimensionalDrawing - Plint, Plint P un Plint R, skats no aizmugures

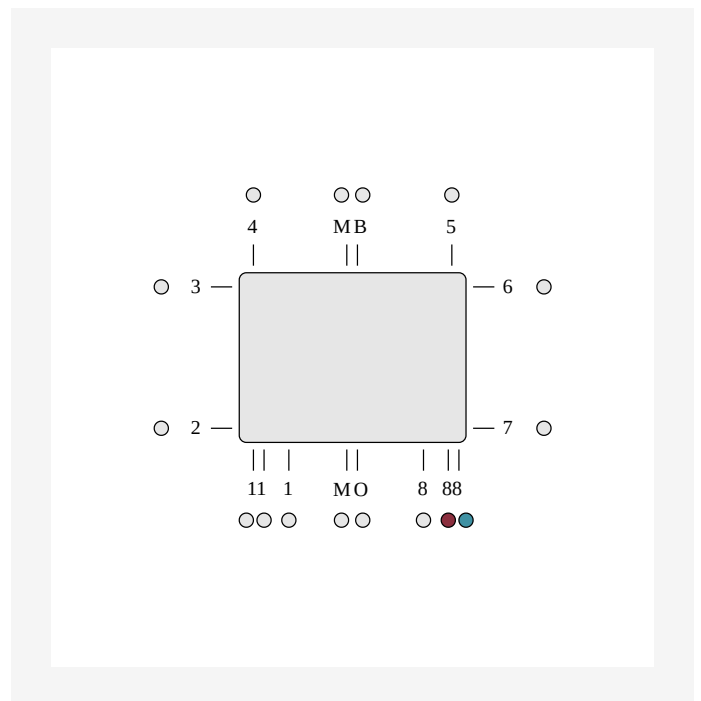

DimensionalDrawing - ETIM 88 LR apakšējais pieslēgums. Apakšējais pieslēgums ar integrētu vārsta prasa vārsta ieliktni izmantošanu. Neizmantojie pieslēgumi ir noslēgti.



Resursi

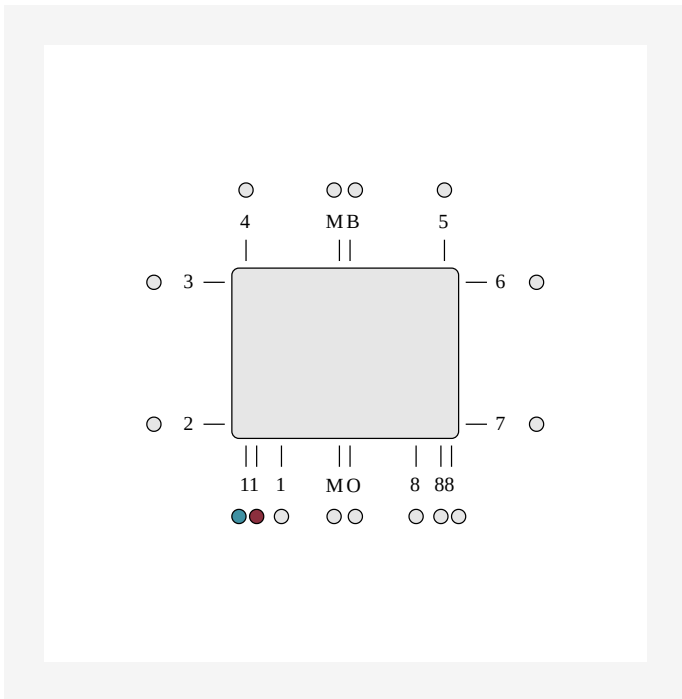

DimensionalDrawing - ETIM 11 apakšējais pieslēgums, ieeja pa labi, izeja pa kreisi. Apakšējais pieslēgums ar integrētu kapilāro cauruli prasa vārsta ieliktna izmantošanu. Neizmantotie pieslēgumi ir aizvērti.



Saistītie produkti



Vārsta inserts M30 OV



Top Grill ©



Gaisa ventilis un aklā aizbāžņa komplekts



Grīdas kronšteins Plint



Remonta krāsa



Sānu panelis ©



Gaisa ventilēšanas atslēga



Sienas kronšteins Monclac
Plint



Remonta krāsas sprejs



Evosense



200

AUGSTUMS 200 mm	GARUMS	DZIĻUMS		Jauda (W) 45/35/20°C	Jauda (W) 55/45/20°C	Jauda (W) 60/45/20°C	TILPUMS (l)	N- ekponents	SVARS (kg)	
Tips 21										
600	72	FOG2102006011310	FOG2102006011300	96	168	183	1.5	1.32	8.3	
700	72	FOG2102007011310	FOG2102007011300	112	196	213	1.8	1.32	10.1	
800	72	FOG2102008011310	FOG2102008011300	128	224	243	2.0	1.32	11.2	
900	72	FOG2102009011310	FOG2102009011300	144	252	274	2.3	1.32	12.4	
1000	72	FOG2102010011310	FOG2102010011300	160	280	304	2.5	1.32	13.8	
1100	72	FOG2102011011310	FOG2102011011300	176	308	335	2.8	1.32	15.2	
1200	72	FOG2102012011310	FOG2102012011300	192	337	365	3.0	1.32	16.6	
1400	72	FOG2102014011310	FOG2102014011300	224	393	426	3.5	1.32	19.8	
1600	72	FOG2102016011310	FOG2102016011300	256	449	487	4.0	1.32	22.4	
1800	72	FOG2102018011310	FOG2102018011300	288	505	548	4.5	1.32	24.8	
2000	72	FOG2102020011310	FOG2102020011300	320	561	608	5.0	1.32	27.6	
2300	72	FOG2102023011310	FOG2102023011300	367	645	700	5.8	1.32	31.7	
2600	72	FOG2102026011310	FOG2102026011300	415	729	791	6.5	1.32	35.9	
3000	72	FOG2102030011310	FOG2102030011300	479	841	913	7.5	1.32	41.4	
Tips 22										
600	104	FOG2202006011310	FOG2202006011300	126	221	240	1.5	1.32	9.2	
700	104	FOG2202007011310	FOG2202007011300	147	258	280	1.8	1.32	11.3	
800	104	FOG2202008011310	FOG2202008011300	167	295	320	2.0	1.32	12.9	
900	104	FOG2202009011310	FOG2202009011300	188	331	360	2.3	1.32	14.5	
1000	104	FOG2202010011310	FOG2202010011300	209	368	400	2.5	1.32	16.1	
1100	104	FOG2202011011310	FOG2202011011300	230	405	439	2.8	1.32	17.8	
1200	104	FOG2202012011310	FOG2202012011300	251	442	479	3.0	1.32	19.4	
1400	104	FOG2202014011310	FOG2202014011300	293	515	559	3.5	1.32	22.6	
1600	104	FOG2202016011310	FOG2202016011300	335	589	639	4.0	1.32	25.8	



200

AUGSTUMS 200 mm	GARUMS	DZIĻUMS		Jauda (W) 45/35/20°C	Jauda (W) 55/45/20°C	Jauda (W) 60/45/20°C	TILPUMS (l)	N- ekponents	SVARS (kg)
	1800	104	FOG2202018011310 FOG2202018011300	377	663	719	4.5	1.32	29.0
	2000	104	FOG2202020011310 FOG2202020011300	419	736	799	5.0	1.32	32.2
	2300	104	FOG2202023011310 FOG2202023011300	481	847	919	5.8	1.32	37.4
	2600	104	FOG2202026011310 FOG2202026011300	544	957	1039	6.5	1.32	41.9
	3000	104	FOG2202030011310 FOG2202030011300	628	1105	1199	7.5	1.32	48.4

Tips 33

	600	154	FOG3302006011310 FOG3302006011300	180	318	345	2.3	1.33	13.8
	700	154	FOG3302007011310 FOG3302007011300	210	371	403	2.7	1.33	16.1
	800	154	FOG3302008011310 FOG3302008011300	240	424	460	3.0	1.33	18.4
	900	154	FOG3302009011310 FOG3302009011300	270	477	518	3.4	1.33	14.6
	1000	154	FOG3302010011310 FOG3302010011300	300	530	575	3.8	1.33	23.6
	1100	154	FOG3302011011310 FOG3302011011300	330	583	633	4.2	1.33	25.4
	1200	154	FOG3302012011310 FOG3302012011300	360	636	690	4.6	1.33	27.7
	1400	154	FOG3302014011310 FOG3302014011300	420	742	805	5.3	1.33	32.3
	1600	154	FOG3302016011310 FOG3302016011300	480	848	920	6.1	1.33	36.9
	1800	154	FOG3302018011310 FOG3302018011300	540	954	1035	6.8	1.33	41.6
	2000	154	FOG3302020011310 FOG3302020011300	600	1059	1150	7.6	1.33	46.1
	2300	154	FOG3302023011310 FOG3302023011300	690	1218	1323	8.7	1.33	53.9
	2600	154	FOG3302026011310 FOG3302026011300	780	1377	1496	9.9	1.33	59.9
	3000	154	FOG3302030011310 FOG3302030011300	900	1589	1726	11.4	1.33	69.2

Tips 44

	600	204	FOG4402006011310 FOG4402006011300	228	405	439	3.3	1.34	17.3
	700	204	FOG4402007011310 FOG4402007011300	266	472	513	3.9	1.34	19.8
	800	204	FOG4402008011310 FOG4402008011300	304	539	586	4.4	1.34	22.7
	900	204	FOG4402009011310 FOG4402009011300	342	607	659	5.0	1.34	25.5
	1000	204	FOG4402010011310 FOG4402010011300	380	674	732	5.5	1.34	29.5



200

AUGSTUMS 200 mm	GARUMS	DZIĻUMS		Jauda (W) 45/35/20°C	Jauda (W) 55/45/20°C	Jauda (W) 60/45/20°C	TILPUMS (l)	N- ekponents	SVARS (kg)
	1100	204	FOG4402011011310 FOG4402011011300	418	742	806	6.0	1.34	31.2
	1200	204	FOG4402012011310 FOG4402012011300	456	809	879	6.6	1.34	34.8
	1400	204	FOG4402014011310 FOG4402014011300	532	944	1025	7.7	1.34	39.8
	1600	204	FOG4402016011310 FOG4402016011300	608	1079	1172	8.8	1.34	45.4
	1800	204	FOG4402018011310 FOG4402018011300	684	1214	1318	9.9	1.34	51.8
	2000	204	FOG4402020011310 FOG4402020011300	760	1348	1465	11.0	1.34	56.8
	2300	204	FOG4402023011310 FOG4402023011300	874	1551	1685	12.7	1.34	65.4
	2600	204	FOG4402026011310 FOG4402026011300	988	1753	1904	14.3	1.34	73.8
	3000	204	FOG4402030011310 FOG4402030011300	1140	2023	2197	16.5	1.34	85.1