



Datu lapa

2026-04-26

Plint R

Nodrošina efektīvu apkuri ar elegantu dizainu.



- ✓ Viegla apkope
- ✓ Labs termiskais komforts
- ✓ Elastīga uzstādīšana
- ✓ Izturīga un uzticama konstrukcija
- ✓ Mūsdienīgs dizains

Plint R paneļu radiators ar gludu priekšējo virsmu un viegliem horizontāliem reljefiem nodrošina estētisku un efektīvu apkures risinājumu. Piemērots sienas vai grīdas montāžai, ar termostātisko vārstu un RAL 9016 apdari.



Pielietojuma joma

Plint R radiatori paredzēti telpām ar lielām stiklotām virsmām. Darba spiediens 10 bar, temperatūra 110°C. Pieslēgumi: 6 porti. Augstums 200 mm, garums 600–3000 mm.

Dimensiju noteikšana

Lai nodrošinātu pareizu produktu izvēli, lūdzu, izmantojiet mūsu kalkulatoru rīkus un produktu bukletus. Ja nepieciešama palīdzība, sazinieties ar mūsu pārdošanas komandu.

Lietošana

Lai nodrošinātu optimālu veiktspēju, Plint R radiatoru uzstādi ar sienas kronšteinjiem vai grīdas statīviem atbilstoši telpas prasībām, pieslēdz visus sešus pieslēguma portus (4 sānu un 2 apakšējos) un nepārsniedz maksimālo spiedienu un temperatūru, regulārā apkope ietver priekšējā paneļa tīrīšanu efektivitātes un izskata saglabāšanai.

AMA teksts

Plint R plāksņu radiatora paredzēts ūdens apkures sistēmām. Pieslēgums no apakšas vai pēc vārsta ieliktna demontāžas — no sāna. Radiatoram ir gluda priekšējā plāte ar vieglām horizontālām reljefa līnijām. Divi ½" apakšējie pieslēgumi nodrošina diskretu instalācijas izvietojumu. Aprīkots ar termostātisko vārstu ar priekšiestatījumu. Standarta krāsa RAL 9016, citi toņi pieejami pēc pieprasījuma. Garantija 10 gadi.



Specifikācijas

ĪPAŠĪBAS	VIENĪBA	VĒRTĪBAS
ETIM klase		EC011022
Materiāls		Tērauds
Tips		21, 22, 33, 44
Virsmas struktūra		Līdzens gluds
Maks. darba spiediens	bar	10
Standarta pieslēgumu skaits		2
Siltuma atdeve pēc EN 442 atzītas laboratorijas		Jā
Maksimālā darbības temperatūra	°C	110
Standarta krāsa		Jā
Krāsa		Balts
RAL numurs		9016
Restes/Vāka plāksne		Jā
Restes/Vāka plāksne		Jā
Spīduma vērtība		Spīdīgs
Vitnes izmērs (collas)		1/2 inch
Pieslēguma vītne		lekšējā vītne
Ar vienpunkta pieslēgumu		Jā
Ar ventilācijas pieslēgumu		Jā
Ar ventilācijas vārstu/gaisa atgaisotāju		Jā
Ar iztukšošanas iespēju		Jā



Resursi



ProductImage - Panel radiator Plint R, 200 mm.

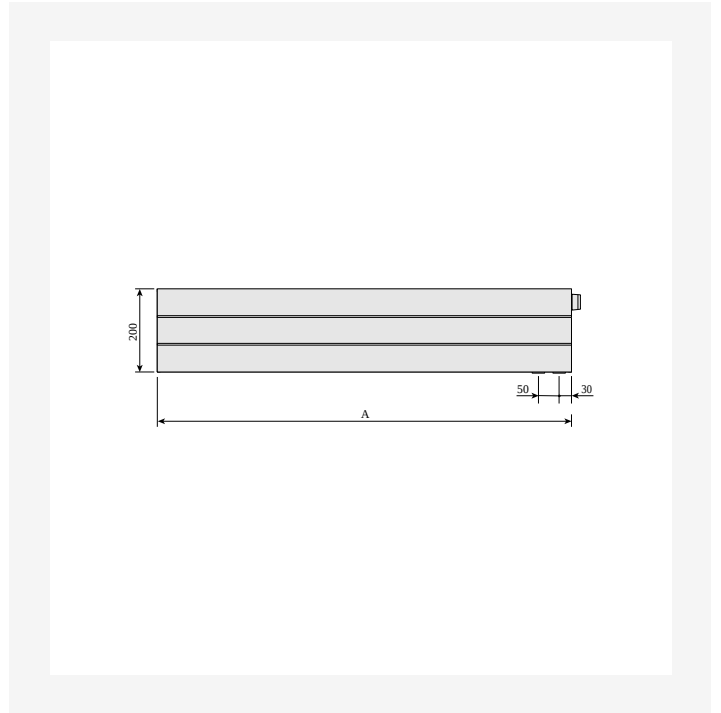

DimensionalDrawing - Plint R un Plint RD, skats no priekšpuses

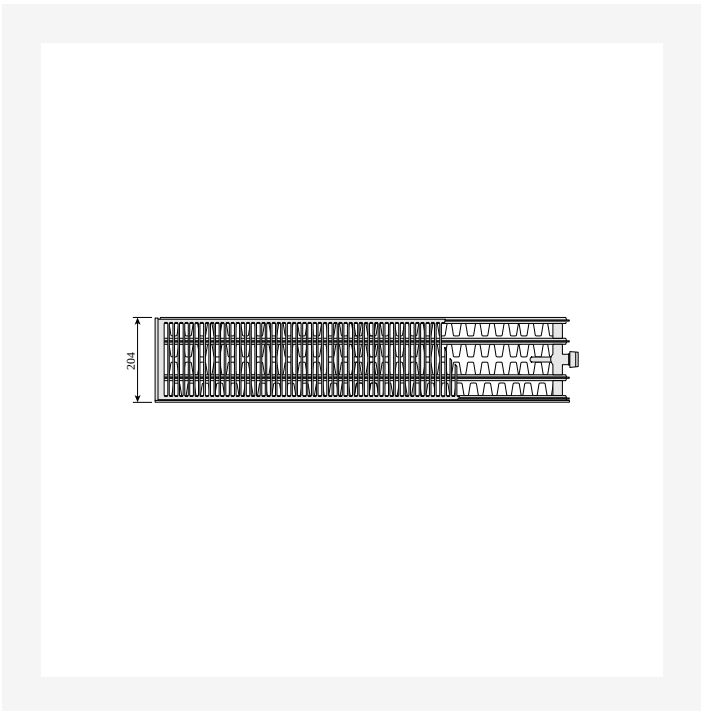

DimensionalDrawing - Plint P un Plint R, tips 44, skats no augšas

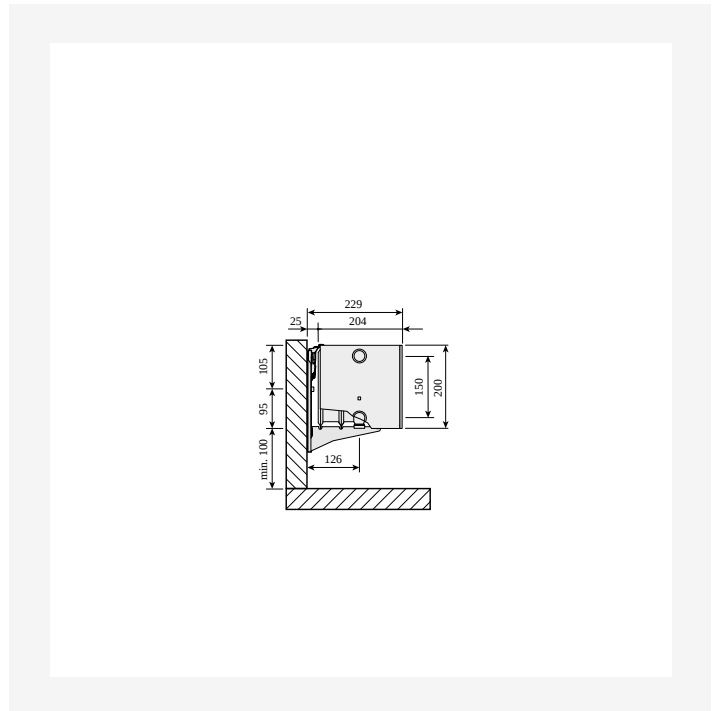

DimensionalDrawing - Plint P un Plint R, tips 44, skats no sāniem ar Monclac sienas kronšteinu



Resursi

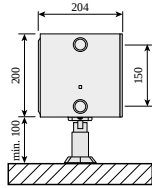

DimensionalDrawing - Plint P un Plint R, tips 44, ar grīdas kronšteinu, skats no sāniem

DimensionalDrawing - Plint P un Plint R, tips 33, skats no augšas

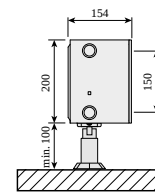
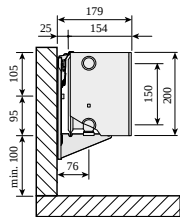

DimensionalDrawing - Plint P un Plint R, tips 33, skats no sāniem ar Monclac sienas kronšteinu

DimensionalDrawing - Plint P un Plint R, tips 33, ar grīdas kronšteinu, skats no sāniem



Resursi

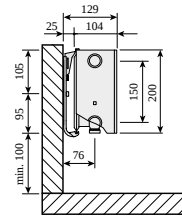

DimensionalDrawing - Plint P un Plint R, tips 22, skats no augšas

DimensionalDrawing - Plint P un Plint R, tips 22, skats no sāniem ar Monclac sienas kronšteiniem

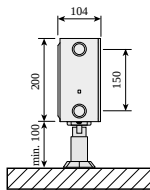

DimensionalDrawing - Plint P un Plint R, tips 22, ar grīdas kronšteiniem, skats no sāniem

DimensionalDrawing - Plint P un Plint R, tips 21s, skats no augšas



Resursi

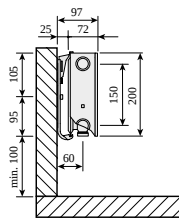

DimensionalDrawing - Plint P un Plint R, tips 21s, skats no sāniem ar Monclac sienas kronšteinu

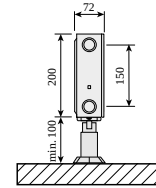

DimensionalDrawing - Plint P un Plint R, tips 21s, ar grīdas kronšteinu, skats no sāniem

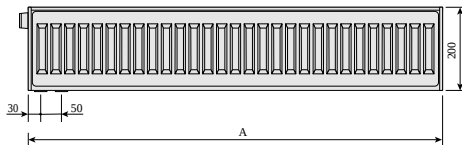

DimensionalDrawing - Plint, Plint P un Plint R, skats no aizmugures

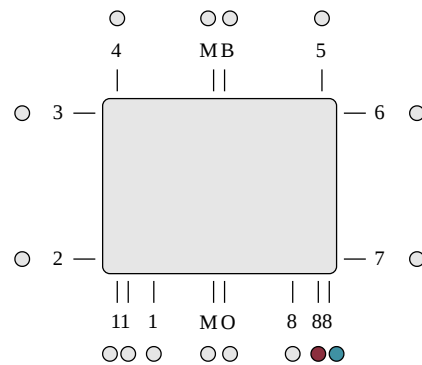

DimensionalDrawing - ETIM 88 LR apakšējais pieslēgums. Apakšējais pieslēgums ar integrētu vārsta prasa vārsta ieliktni izmantošanu. Neizmantojamie pieslēgumi ir noslēgti.



Resursi

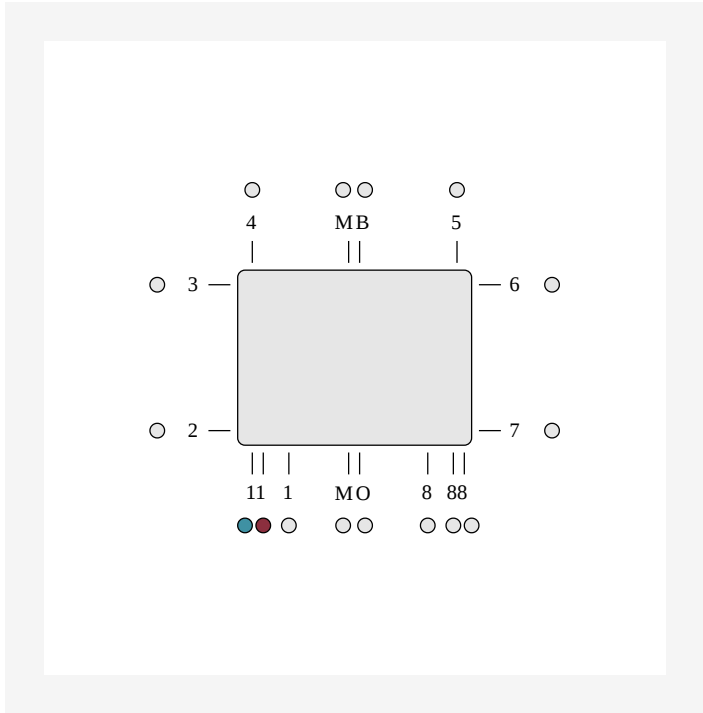

DimensionalDrawing - ETIM 11 apakšējais pieslēgums, ieeja pa labi, izeja pa kreisi. Apakšējais pieslēgums ar integrētu kapilāro cauruli prasa vārsta ieliktna izmantošanu. Neizmantojie pieslēgumi ir aizvērti.



Saistītie produkti

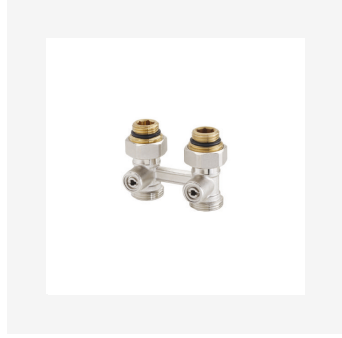



Saistītie produkti





200

AUGSTUMS 200 mm	GARUMS	DZIĻUMS		Jauda (W) 45/35/20°C	Jauda (W) 55/45/20°C	Jauda (W) 60/45/20°C	TILPUMS (l)	N- ekponents	SVARS (kg)
Tips 21									
800	72		FOG2102008011310	128	224	243	2.0	1.32	11.2
900	72		FOG2102009011300	144	252	274	2.3	1.32	12.4
1000	72		FOG2102010011300	160	280	304	2.5	1.32	13.8
1100	72		FOG2102011011310 FOG2102011011300	176	308	335	2.8	1.32	15.2
1200	72		FOG2102012011300	192	337	365	3.0	1.32	16.6
1800	72		FOG2102018011300	288	505	548	4.5	1.32	24.8
2000	72		FOG2102020011300	320	561	608	5.0	1.32	27.6
2300	72		FOG2102023011310 FOG2102023011300	367	645	700	5.8	1.32	31.7
2600	72		FOG2102026011300	415	729	791	6.5	1.32	35.9
Tips 22									
600	104		FOG2202006011310	126	221	240	1.5	1.32	9.2
700	104		FOG2202007011310 FOG2202007011300	147	258	280	1.8	1.32	11.3
800	104		FOG2202008011310 FOG2202008011300	167	295	320	2.0	1.32	12.9
900	104		FOG2202009011310	188	331	360	2.3	1.32	14.5
1000	104		FOG2202010011310	209	368	400	2.5	1.32	16.1
1100	104		FOG2202011011300	230	405	439	2.8	1.32	17.8
1200	104		FOG2202012011300	251	442	479	3.0	1.32	19.4
1400	104		FOG2202014011310	293	515	559	3.5	1.32	22.6
1600	104		FOG2202016011300	335	589	639	4.0	1.32	25.8
2000	104		FOG2202020011300	419	736	799	5.0	1.32	32.2
2600	104		FOG2202026011310 FOG2202026011300	544	957	1039	6.5	1.32	41.9
Tips 33									
600	154		FOG3302006011310	180	318	345	2.3	1.33	13.8
700	154		FOG3302007011310 FOG3302007011300	210	371	403	2.7	1.33	16.1



200

AUGSTUMS 200 mm	GARUMS	DZIĻUMS		Jauda (W) 45/35/20°C	Jauda (W) 55/45/20°C	Jauda (W) 60/45/20°C	TILPUMS (l)	N- ekponents	SVARS (kg)
	800	154	FOG3302008011300	240	424	460	3.0	1.33	18.4
	1000	154	FOG3302010011300	300	530	575	3.8	1.33	23.6
	1100	154	FOG3302011011300	330	583	633	4.2	1.33	25.4
	1400	154	FOG3302014011310 FOG3302014011300	420	742	805	5.3	1.33	32.3
	1600	154	FOG3302016011310	480	848	920	6.1	1.33	36.9
	1800	154	FOG3302018011310	540	954	1035	6.8	1.33	41.6
	2000	154	FOG3302020011310	600	1059	1150	7.6	1.33	46.1
	2300	154	FOG3302023011300	690	1218	1323	8.7	1.33	53.9
	2600	154	FOG3302026011310	780	1377	1496	9.9	1.33	59.9
Tips 44									
	800	204	FOG4402008011310	304	539	586	4.4	1.34	22.7
	900	204	FOG4402009011300	342	607	659	5.0	1.34	25.5
	1000	204	FOG4402010011310	380	674	732	5.5	1.34	29.5
	1200	204	FOG4402012011310	456	809	879	6.6	1.34	34.8
	1400	204	FOG4402014011310	532	944	1025	7.7	1.34	39.8
	1600	204	FOG4402016011310 FOG4402016011300	608	1079	1172	8.8	1.34	45.4
	2000	204	FOG4402020011310	760	1348	1465	11.0	1.34	56.8
	2300	204	FOG4402023011310 FOG4402023011300	874	1551	1685	12.7	1.34	65.4
	2600	204	FOG4402026011310	988	1753	1904	14.3	1.34	73.8
	3000	204	FOG4402030011310	1140	2023	2197	16.5	1.34	85.1