



Datenblatt

2026-06-28

Ramo Ventil Compact

Der Ramo Ventil Compact ist ein klassischer Kompaktheizkörper mit ...



- ✓ Plane Vorderfront
- ✓ flexible Anschlußmöglichkeiten
- ✓ 6 Anschlüsse (4xseitlich, 2x unten)
- ✓ Große Vielfalt an Bauhöhen und -tiefen
- ✓ Elegantes Design

Der **Ramo Ventil Compact** ist ein klassischer Kompaktheizkörper mit einer flachen, feinprofilierten Front für geschlossene warmwasserbasierte Heizsysteme. Seine integrierte Ventilgarnitur ermöglicht eine attraktive und einfache Installation. Die Beschichtung ist standardmäßig weiß - RAL 9016.



Anwendungsbereich

Der Ramo Ventil Compact ist ein klassischer Kompaktheizkörper mit einer flachen, feinprofilierten Front für geschlossene warmwasserbasierte Heizsysteme. Seine integrierte Ventilgarnitur ermöglicht eine attraktive und einfache Installation. Die Beschichtung ist standardmäßig weiß - RAL 9016.

Dimensionierung

Für die richtige Produktauswahl oder weitere Infos nutzen Sie bitte unsere technischen Unterlagen, Produkthandbücher, unseren Planungsservice oder kontaktieren Sie uns via E-Mail oder Telefon.

Verwendung

Der Ramo Ventil Compact ist ein klassischer Kompaktheizkörper mit einer flachen, feinprofilierten Front für geschlossene warmwasserbasierte Heizsysteme. Seine integrierte Ventilgarnitur ermöglicht eine attraktive und einfache Installation. Die Beschichtung ist standardmäßig weiß - RAL 9016.

Ausschreibungstext

Purmo Ramo Ventil Compact
6-Muffen-Ventilheizkörper mit feinprofilierter Planfront ohne Laschenaufhängung Typen 21 S, 22, 33 und 44, Standard Rechtsanschluss mit Laschenaufhängung Typ 11, Standard Rechtsanschluss

Fertiglackierter, mit Epoxydharzpulver beschichteter Heizkörper aus Stahlblech DC01 nach EN 10130 und EN 10131, Blechdicke gemäß Anforderungen der EN 442-1, mit einseitiger, verzinkter feinprofilierter Planfront, zur Anwendung in Warmwasserheizungsanlagen nach DIN 4751.

Entfettet, phosphatiert, im KTL-Verfahren tauchgrundiert und pulverbeschichtet nach DIN 55 900.

Wärmeleistung gemäß EN 442 und bei WSP-CERT registriert.

RAL-Gütezeichen, 10 Jahre Garantie

Montageverpackt, mit Pappkantenschutz, Pappschutzecken und Schrumpffolie.

Mit integrierter Ventilgarnitur und serienmäßig voreinstellbarem Ventileinsatz (Regelbereich 0,05 -0,70 m³/h) zum Anbau von Thermostat-Ventilköpfen.

Ventileinsatz leistungsmäßig werkseitig voreingestellt und farbig gekennzeichnet. Ventilgarnitur werkseitig für 2-Rohr-Betrieb, Anschlussmöglichkeit von unten über entsprechende Anschlussverschraubungen. Anschluss seitlich 4 x G ½" möglich.

Mit Zierabdeckung und Seitenverkleidungen, ab Baulänge 1800 mm mit zusätzlicher Befestigung der Zierabdeckung fertig montiert.

Bauhöhe 200 mm ohne Befestigung; Bauhöhen 300 bis 900 mm einschließlich FZ-Halterung (VDI 6036, AK2) mit Schallschutzeinlage inkl. Aushebesicherung für Typen 21S, 22 + 33 bzw. Schnellmontage-Set (VDI 6036, AK2) mit Aushebesicherungen und Schallschutzeinlagen für Typ 11, inkl. Schrauben und Dübel.

Ventileinsatz ½", Blind- und Entlüftungsstopfen werkseitig montiert

Ventilgarnitur standardmäßig rechts, auf Wunsch als Sonderanfertigung links ohne Mehrpreis lieferbar

Farbe: RAL 9016, weitere RAL Farben auf Anfrage

Betriebsdruck: 10 bar

Prüfdruck: 13 bar

Temperatur: max. 120° C

Medium: Wasser

Anschlüsse: 2 x G ½" unten, 4 x G ½" seitlich, nach ISO 228

Typen: 11-EK; 21S-EKE schmal; 22-DK; 33-DKEK, 44-EKDKEK (BH 200)

Bauhöhen: 200, 300, 400, 500, 600, 900 mm

Baulängen: 400...2000 mm

Liefernachweis: PG Germany GmbH · Lierestraße 68 · 38690 Goslar

Telefon (0 53 24) 8 08-0 · Telefax (0 53 24) 8 08-999

Stück Typ: 11-EK, Ventil-Kompaktheizkörper - liefern
Bauhöhe:.....mm; Baulänge:mm - montieren

Stück Typ: 21S-EKE schmal, Ventil-Kompaktheizkörper - liefern
Bauhöhe:.....mm; Baulänge:mm - montieren

Stück Typ: 22-DK, Ventil-Kompaktheizkörper - liefern
Bauhöhe:mm; Baulänge:mm - montieren

Stück Typ: 33-DKEK, Ventil-Kompaktheizkörper - liefern
Bauhöhe:mm; Baulänge:mm - montieren

Stück Typ: 44-EKDKEK, Ventil-Kompaktheizkörper - liefern
Bauhöhe:mm; Baulänge:mm - montieren



Spezifikationen

EIGENSCHAFTEN	EINHEIT	WERTE
ETIM-Klasse		EC011022
Material		Stahl
Typ		11, 21, 22, 33
Bauart		flach glatt
Maximaler Betriebsdruck	bar	10
Anzahl der Standardanschlüsse		2
Wärmeleistung nach DIN EN 442 zertifiziert		Ja
Max. Betriebstemperatur	°C	110
Standardfarbe		Ja
Farbe		weiß
RAL-Nummer		9016
Zierritter		Ja
Seitenteile		Ja
Glanzgrad		glänzend
Gewindemaß (Zoll)		1/2 Zoll
Gewindeanschluss		Innengewinde
Mit Einpunktanschluss		Ja
Mit Entlüftungsanschluss		Ja
Mit Entlüftungsventil		Ja
Mit Entleerungsmöglichkeit		Ja



Dokumente

DOKUMENTE	DOKUMENTENTYP	LINK
Gesamtprospekt Purmo Produktkatalog	ProductCatalog	https://asset.productmarketingcloud.com/api/assetstorage/3577_2fa18b7b-6b77-472f-80d4-925ab66fb184
Montageanleitung_MCW_5_console	User	https://asset.productmarketingcloud.com/api/assetstorage/3577_b74fea56-fd9b-471b-b884-8bdd1117186d
Garantiebedingungen Heizkörper, Konvektoren und andere Komponenten	Warranty	https://asset.productmarketingcloud.com/api/assetstorage/3577_0b2455b1-4f72-4336-9409-00a3bb24227d
Montageanleitung FZ-Halterungen für Flachheizkörper	Installation	https://asset.productmarketingcloud.com/api/assetstorage/3577_40b8e51f-c96a-48bf-80ee-9adbe248dcac
Montageanleitung Schnellmontage-Set	Installation	https://asset.productmarketingcloud.com/api/assetstorage/3577_a03319f4-b913-485e-8b9e-437f1dde6ab3
Montageanleitung Standkonsole BH 300-900 mm	Installation	https://asset.productmarketingcloud.com/api/assetstorage/3577_73b1b432-1a36-40d5-944f-9374edb49a53
Leistungskalkulator Flachheizkörper	TechDia	https://asset.productmarketingcloud.com/api/assetstorage/3577_2da398bb-5820-4a58-af2d-62333aa4e65e



Ressourcen



ProductImage - Panel radiator Ramo Ventil Compact, RCV.

RAMO VENTIL COMPACT (mm)		
	RCV11	
A	a1	a2
400-1600	117	-
1800	117	917
2000	117	1017
2300	117	1150
2600	117	1317
3000	117	1517

DimensionalDrawing - Ramo-Ventil-Compact-table drawings a

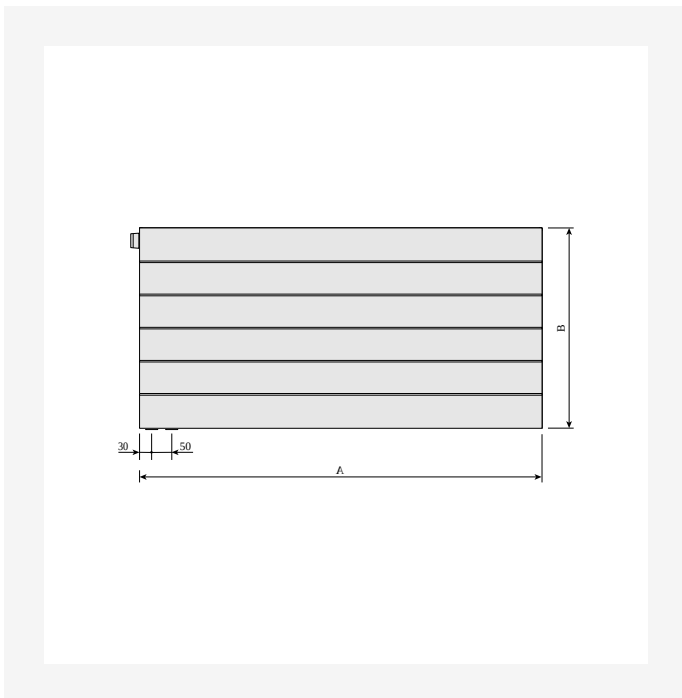

DimensionalDrawing - Ramo Ventil Compact, front view left

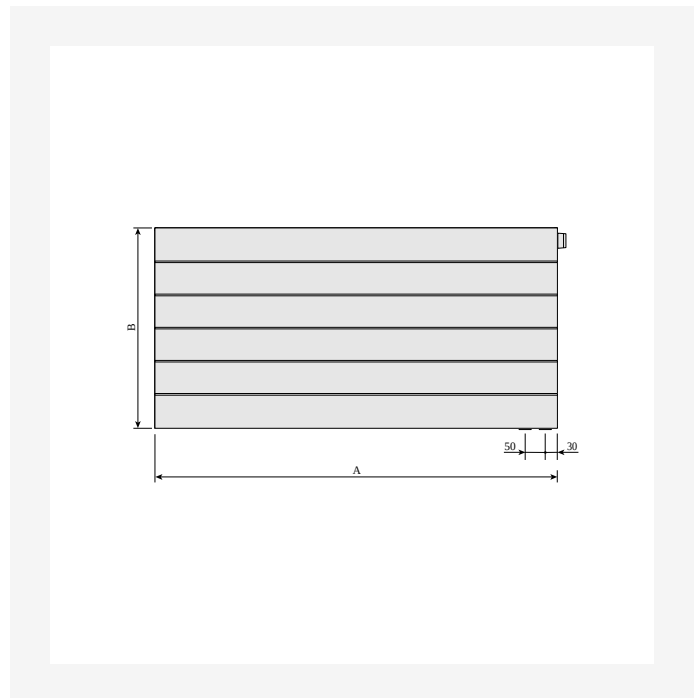

DimensionalDrawing - Ramo Ventil Compact, front view right



Ressourcen

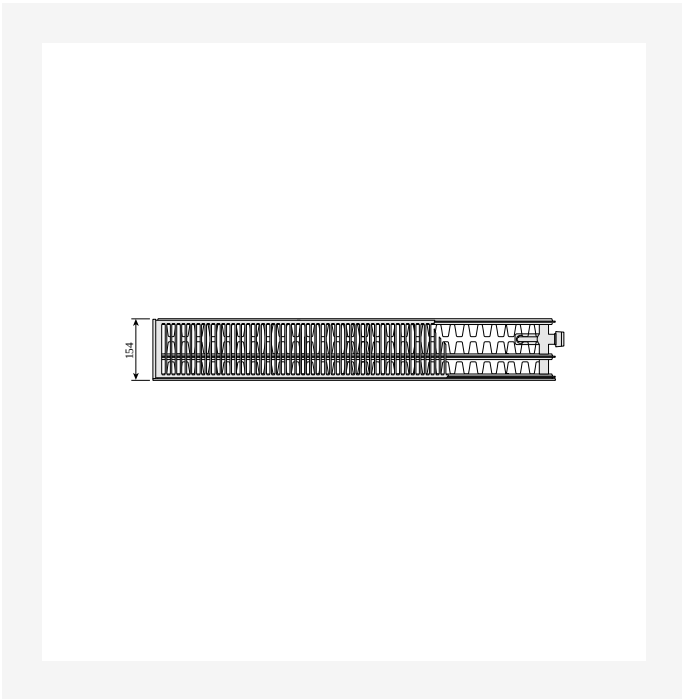

Dimensional Drawing - Plan Ventil Compact and Ramo Ventil Compact, type 33 right, top view

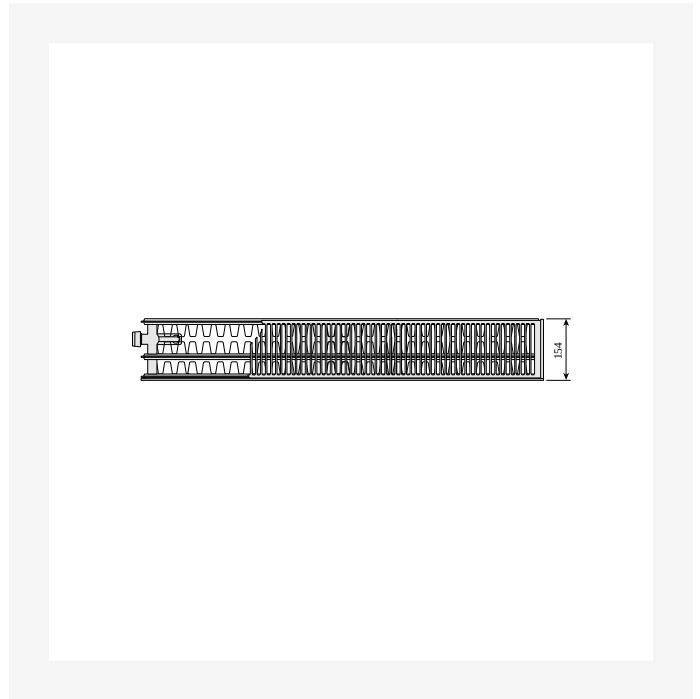

Dimensional Drawing - Plan Ventil Compact and Ramo Ventil Compact, type 33 left, top view

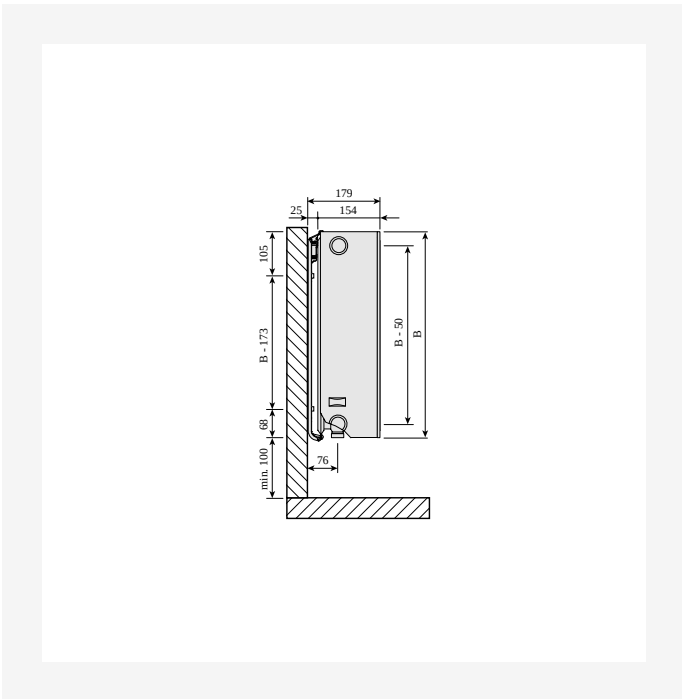

Dimensional Drawing - Plan Ventil Compact and Ramo Ventil Compact, types 30-33, side view

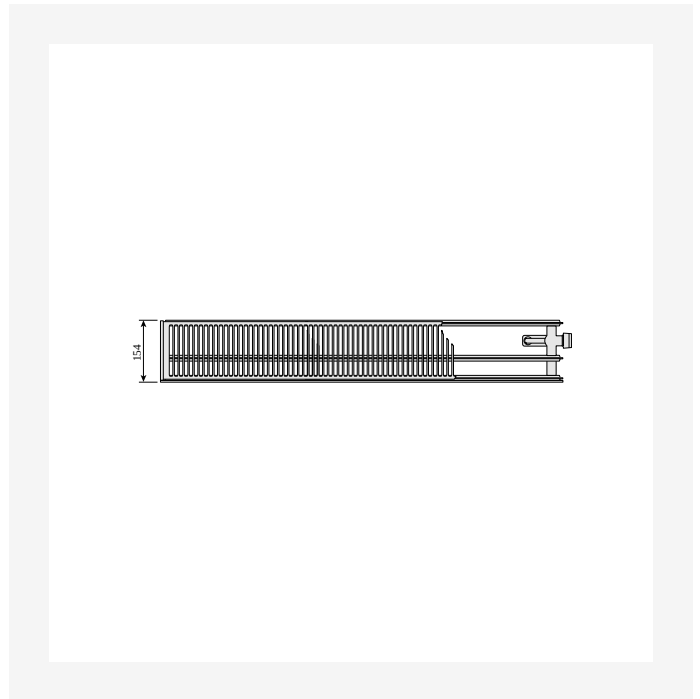

Dimensional Drawing - Plan Ventil Compact and Ramo Ventil Compact, type 30 right, top view



Ressourcen

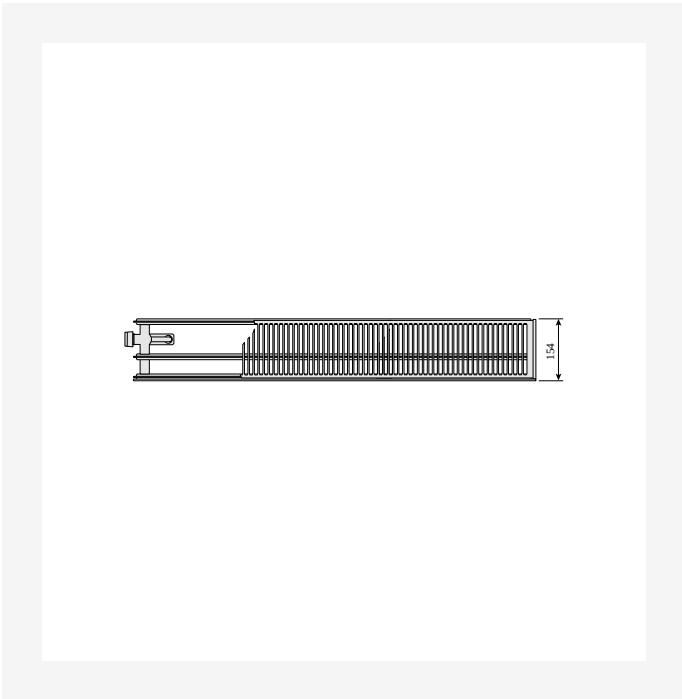

DimensionalDrawing - Plan Ventil Compact and Ramo Ventil Compact, type 30 left, top view



DimensionalDrawing - Plan Ventil Compact and Ramo Ventil Compact, type 22 right, top view



DimensionalDrawing - Plan Ventil Compact and Ramo Ventil Compact, type 22 left, top view

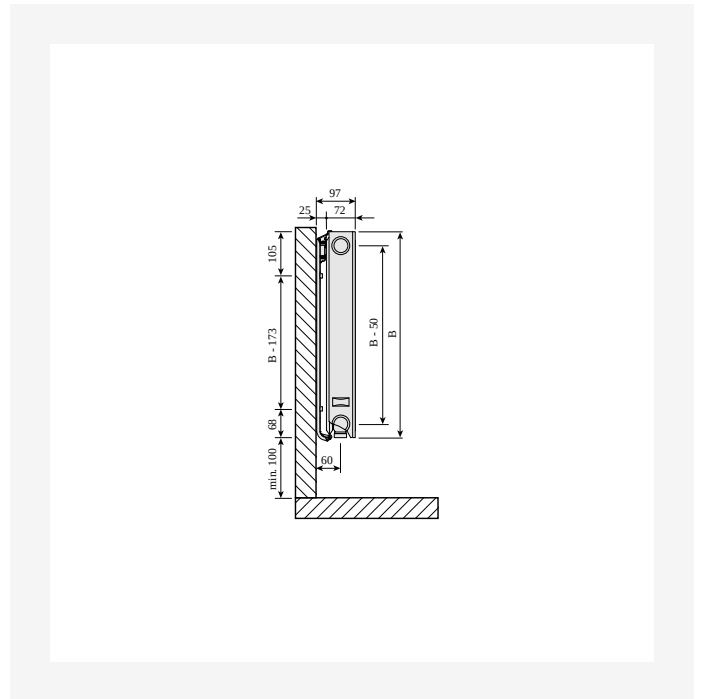

DimensionalDrawing - Plan Ventil Compact and Ramo Ventil Compact, type 21s, side view



Ressourcen

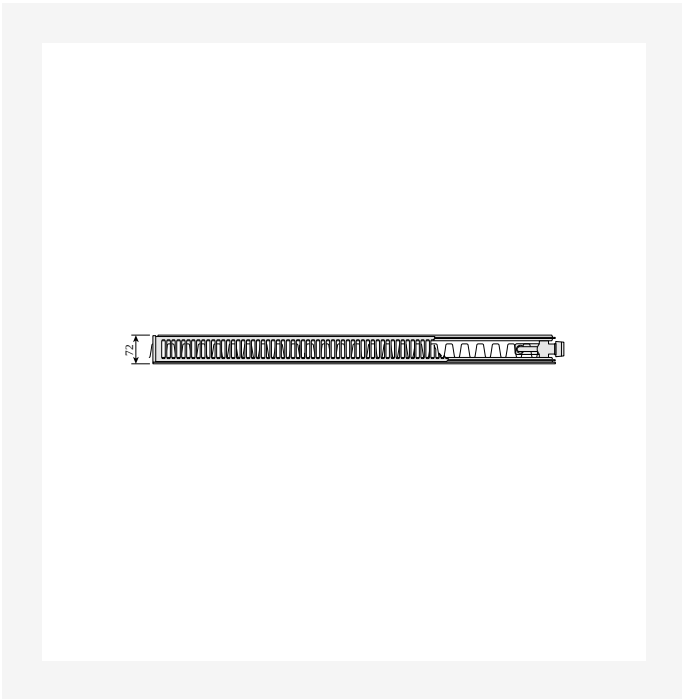

Dimensional Drawing - Plan Ventil Compact and Ramo Ventil Compact, type 21s right, top view

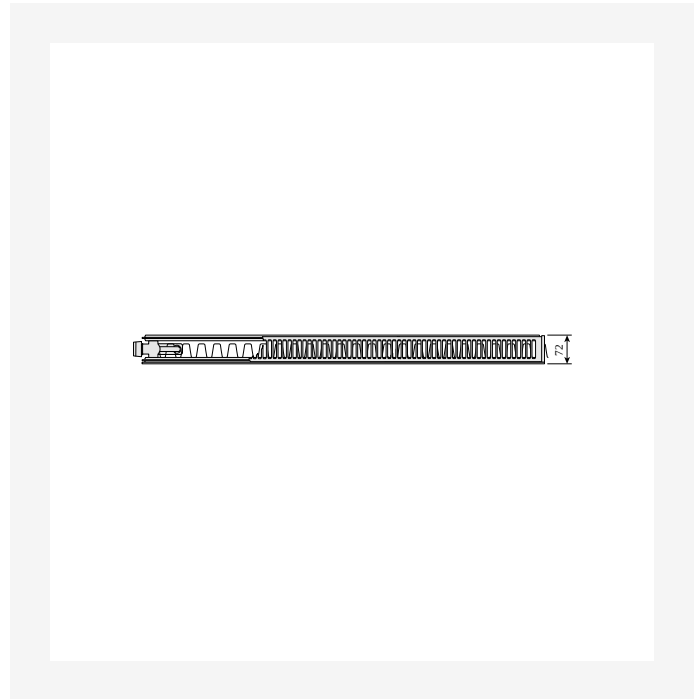

Dimensional Drawing - Plan Ventil Compact and Ramo Ventil Compact, type 21s left, top view

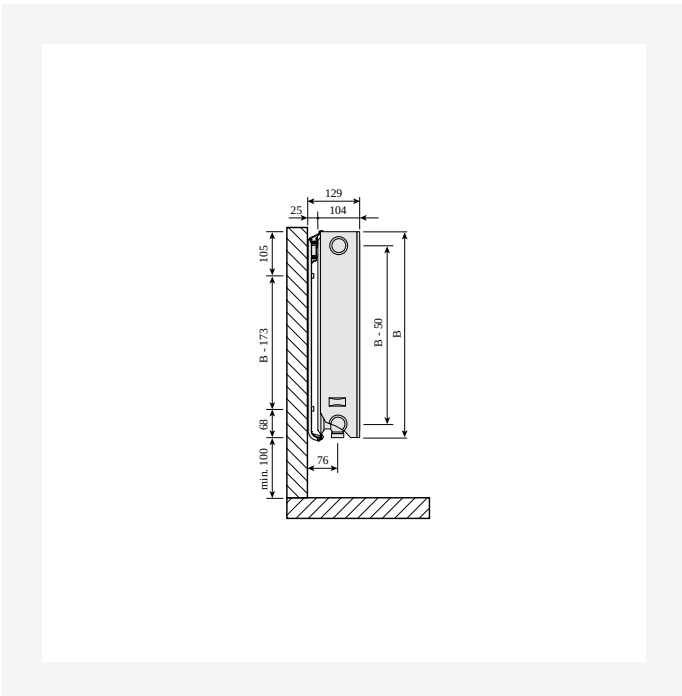

Dimensional Drawing - Plan Ventil Compact and Ramo Ventil Compact types 20-22, side view

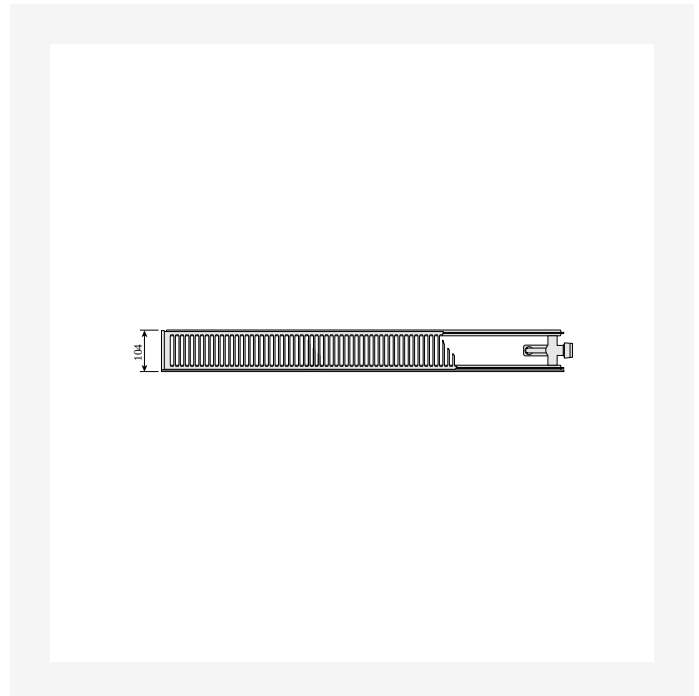

Dimensional Drawing - Plan Ventil Compact and Ramo Ventil Compact, type 20 right, top view



Ressourcen

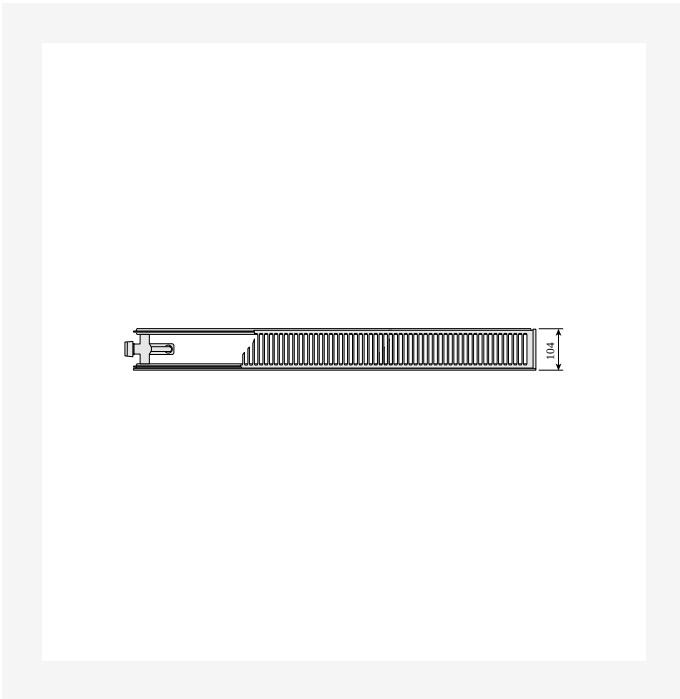

DimensionalDrawing - Plan Ventil Compact and Ramo Ventil Compact, type 20 left, top view

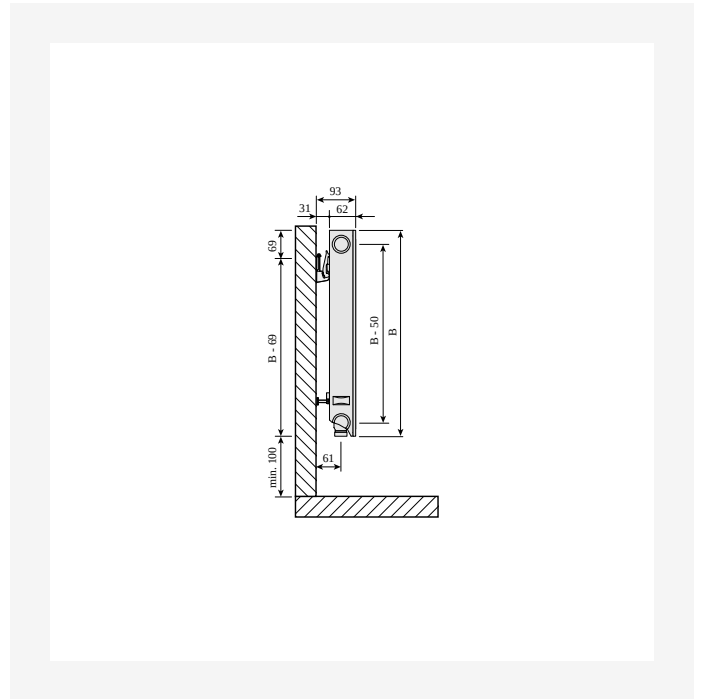

DimensionalDrawing - Plan Ventil Compact and Ramo Ventil Compact type 11, side view

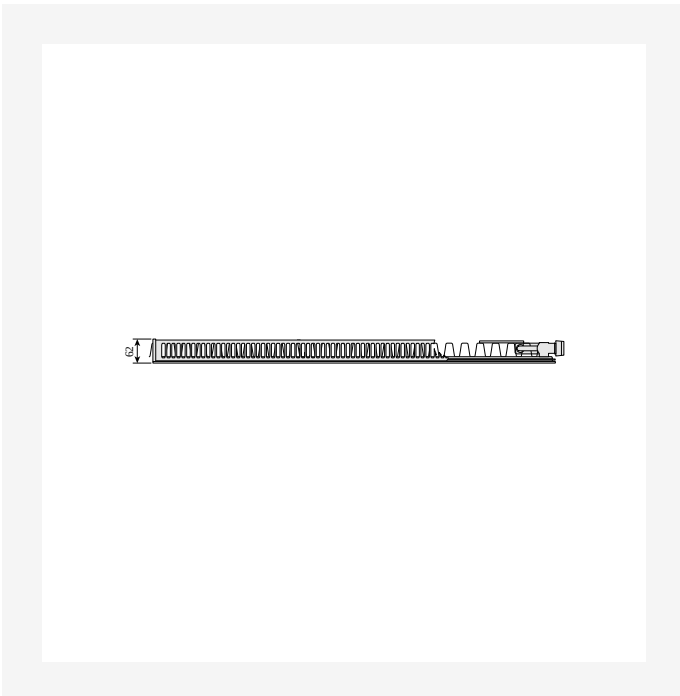

DimensionalDrawing - Plan Ventil Compact and Ramo Ventil Compact, type 11 right, top view

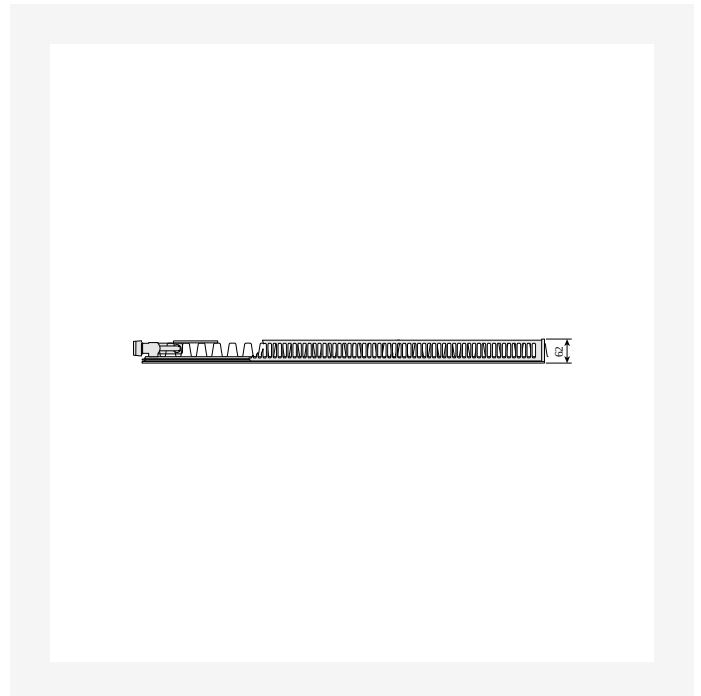

DimensionalDrawing - Plan Ventil Compact and Ramo Ventil Compact type 11 left, top view



Verwandte Produkte



Reinigungsbürste



300

Höhe 300 mm	Länge	Tiefe	Artikelnummer (links)	Artikelnummer (rechts)	Systemtemperatur 55/45/20 °C	Systemtemperatur 70/55/20 °C	Systemtemperatur 75/65/20 °C	Volumen (l)	Exponent n	Gewicht (kg)
Typ 11										
400	62		FOG1103004010310	FOG1103004010300	110	172	212	0.7	1.28	5.6
600	62		FOG1103006010310	FOG1103006010300	165	258	317	1.0	1.28	7.7
700	62		FOG1103007010310	FOG1103007010300	192	301	370	1.2	1.28	8.8
800	62		FOG1103008010300		220	344	423	1.4	1.28	10.2
900	62		FOG1103009010310	FOG1103009010300	247	387	476	1.5	1.28	1.9
1000	62		FOG1103010010310	FOG1103010010300	275	430	529	1.7	1.28	11.9
1100	62		FOG1103011010310	FOG1103011010300	302	472	582	1.9	1.28	13.1
1400	62		FOG1103014010310	FOG1103014010300	385	601	741	2.4	1.28	16.2
1600	62		FOG1103016010310		440	687	846	2.7	1.28	18.3
1800	62		FOG1103018010310	FOG1103018010300	495	773	952	3.1	1.28	2.4
2000	62		FOG1103020010310	FOG1103020010300	550	859	1058	3.4	1.28	22.5
2300	62		FOG1103023010310	FOG1103023010300	632	988	1217	3.9	1.28	25.8
2600	62		FOG1103026010310	FOG1103026010300	715	1117	1375	4.4	1.28	28.9
3000	62		FOG1103030010310	FOG1103030010300	824	1289	1587	5.1	1.28	33.1
Typ 21										
400	72		FOG2103004011310	FOG2103004011300	152	238	293	1.4	1.28	7.6
500	72		FOG2103005011310	FOG2103005011300	190	297	366	1.7	1.28	9.2
600	72		FOG2103006011310		229	357	439	2.0	1.28	1.7
700	72		FOG2103007011310		267	416	512	2.4	1.28	12.2
800	72		FOG2103008011310	FOG2103008011300	305	476	586	2.7	1.28	14.2
900	72		FOG2103009011300		343	535	659	3.1	1.28	15.2
1000	72		FOG2103010011310	FOG2103010011300	381	595	732	3.4	1.28	16.7
1100	72		FOG2103011011310	FOG2103011011300	419	654	805	3.7	1.28	18.2
1200	72		FOG2103012011310	FOG2103012011300	457	714	878	4.1	1.28	19.7



300

Höhe 300 mm	Länge	Tiefe	Artikelnummer (links)	Artikelnummer (rechts)	Systemtemperatur 55/45/20 °C	Systemtemperatur 70/55/20 °C	Systemtemperatur 75/65/20 °C	Volumen (l)	Exponent n	Gewicht (kg)
	1400	72		FOG2103014011300	533	833	1025	4.8	1.28	22.7
	1600	72	FOG2103016011310	FOG2103016011300	610	951	1171	5.4	1.28	25.8
	1800	72	FOG2103018011310	FOG2103018011300	686	1070	1318	6.1	1.28	28.8
	2000	72		FOG2103020011310	762	1189	1464	6.8	1.28	31.8
	2600	72	FOG2103026011310	FOG2103026011300	990	1546	1903	8.8	1.28	4.9
	3000	72		FOG2103030011310	1143	1784	2196	10.2	1.28	46.9

Typ 22

	400	104	FOG2203004011310	FOG2203004011300	193	303	375	1.4	1.30	8.6
	500	104	FOG2203005011310	FOG2203005011300	241	379	469	1.7	1.30	1.2
	600	104		FOG2203006011310	289	455	562	2.0	1.30	11.9
	800	104		FOG2203008011310	386	607	750	2.7	1.30	15.2
	900	104		FOG2203009011310	434	683	843	3.1	1.30	16.9
	1000	104	FOG2203010011310	FOG2203010011300	482	759	937	3.4	1.30	18.5
	1100	104		FOG2203011011300	531	834	1031	3.7	1.30	2.2
	1200	104		FOG2203012011310	579	910	1124	4.1	1.30	21.9
	1400	104	FOG2203014011310	FOG2203014011300	675	1062	1312	4.8	1.30	25.2
	1600	104	FOG2203016011310	FOG2203016011300	772	1214	1499	5.4	1.30	28.5
	1800	104		FOG2203018011300	868	1365	1687	6.1	1.30	31.8
	2000	104		FOG2203020011310	965	1517	1874	6.8	1.30	35.1
	2300	104	FOG2203023011310	FOG2203023011300	1109	1745	2155	7.8	1.30	4.1
	2600	104		FOG2203026011310	1254	1972	2436	8.8	1.30	45.1

Typ 33

	400	154	FOG3303004011310	FOG3303004011300	268	424	526	2.0	1.32	11.7
	500	154	FOG3303005011310	FOG3303005011300	335	531	657	2.5	1.32	14.5
	600	154	FOG3303006011310	FOG3303006011300	403	637	788	3.1	1.32	16.4
	700	154	FOG3303007011310	FOG3303007011300	470	743	920	3.6	1.32	18.8



300

Höhe 300 mm	Länge	Tiefe	Artikelnummer (links)	Artikelnummer (rechts)	Systemtemperatur 55/45/20 °C	Systemtemperatur 70/55/20 °C	Systemtemperatur 75/65/20 °C	Volumen (l)	Exponent n	Gewicht (kg)
	800	154	FOG3303008011310	FOG3303008011300	537	849	1051	4.1	1.32	21.2
	900	154	FOG3303009011310	FOG3303009011300	604	955	1183	4.6	1.32	23.5
	1000	154	FOG3303010011310		671	1061	1314	5.1	1.32	25.9
	1100	154	FOG3303011011310	FOG3303011011300	738	1167	1445	5.6	1.32	28.3
	1200	154	FOG3303012011310	FOG3303012011300	805	1273	1577	6.1	1.32	3.6
	1400	154	FOG3303014011310		939	1485	1840	7.1	1.32	35.4
	1600	154	FOG3303016011310		1073	1698	2102	8.2	1.32	4.1
	1800	154	FOG3303018011310	FOG3303018011300	1208	1910	2365	9.2	1.32	44.9
	2000	154	FOG3303020011310		1342	2122	2628	10.2	1.32	49.6
	2300	154	FOG3303023011310	FOG3303023011300	1543	2440	3022	11.7	1.32	56.8
	2600	154	FOG3303026011310	FOG3303026011300	1744	2759	3416	13.3	1.32	63.8
	3000	154	FOG3303030011300		2013	3183	3942	15.3	1.32	73.3



400

Höhe 400 mm	Länge	Tiefe	Artikelnummer (links)	Artikelnummer (rechts)	Systemtemperatur 55/45/20 °C	Systemtemperatur 70/55/20 °C	Systemtemperatur 75/65/20 °C	Volumen (l)	Exponent n	Gewicht (kg)
Typ 11										
400	62		FOG1104004010310	FOG1104004010300	141	221	272	0.9	1.28	7.4
500	62		FOG1104005010310	FOG1104005010300	177	276	340	1.1	1.28	8.5
600	62		FOG1104006010310		212	331	408	1.3	1.28	10.4
700	62		FOG1104007010310	FOG1104007010300	247	386	476	1.5	1.28	11.4
800	62		FOG1104008010300		283	442	544	1.8	1.28	12.8
900	62		FOG1104009010310		318	497	612	2.0	1.28	14.3
1000	62		FOG1104010010310	FOG1104010010300	353	552	680	2.2	1.28	15.7
1400	62		FOG1104014010300		494	773	952	3.1	1.28	21.4
1600	62		FOG1104016010310	FOG1104016010300	565	883	1088	3.5	1.28	24.3
1800	62		FOG1104018010310	FOG1104018010300	636	994	1224	4.0	1.28	27.2
2000	62		FOG1104020010310	FOG1104020010300	706	1104	1360	4.4	1.28	3.2
2300	62		FOG1104023010300		812	1270	1564	5.1	1.28	34.3
3000	62		FOG1104030010310	FOG1104030010300	1060	1656	2040	6.6	1.28	44.4
Typ 21										
400	72		FOG2104004011310	FOG2104004011300	193	302	372	1.8	1.28	10.4
500	72		FOG2104005011310	FOG2104005011300	241	377	465	2.3	1.28	12.0
600	72		FOG2104006011310	FOG2104006011300	289	452	557	2.7	1.28	14.0
700	72		FOG2104007011310		337	528	650	3.1	1.28	16.0
800	72		FOG2104008011310	FOG2104008011300	386	603	743	3.6	1.28	18.0
900	72		FOG2104009011310	FOG2104009011300	434	679	836	4.0	1.28	20.0
1000	72		FOG2104010011310	FOG2104010011300	482	754	929	4.5	1.28	22.0
1100	72		FOG2104011011310		530	829	1022	5.0	1.28	24.0
1200	72		FOG2104012011300		578	905	1115	5.4	1.28	26.0
1400	72		FOG2104014011310	FOG2104014011300	675	1056	1301	6.3	1.28	30.0
1600	72		FOG2104016011310	FOG2104016011300	771	1206	1486	7.2	1.28	34.0



400

Höhe 400 mm	Länge	Tiefe	Artikelnummer (links)	Artikelnummer (rechts)	Systemtemperatur 55/45/20 °C	Systemtemperatur 70/55/20 °C	Systemtemperatur 75/65/20 °C	Volumen (l)	Exponent n	Gewicht (kg)
	2000	72	FOG2104020011310	FOG2104020011300	964	1508	1858	9.0	1.28	42.5
	2300	72	FOG2104023011310	FOG2104023011300	1109	1734	2137	10.3	1.28	48.8
	2600	72	FOG2104026011300		1253	1960	2415	11.7	1.28	54.2
	3000	72	FOG2104030011310		1446	2262	2787	13.5	1.28	62.3
Typ 22										
	400	104	FOG2204004011310	FOG2204004011300	245	387	479	1.8	1.31	11.5
	500	104	FOG2204005011310	FOG2204005011300	307	484	599	2.3	1.31	13.4
	600	104	FOG2204006011310		368	581	719	2.7	1.31	15.6
	700	104	FOG2204007011310	FOG2204007011300	430	678	839	3.1	1.31	17.9
	800	104	FOG2204008011310		491	775	958	3.6	1.31	2.2
	900	104	FOG2204009011310		552	871	1078	4.0	1.31	22.4
	1000	104	FOG2204010011310	FOG2204010011300	614	968	1198	4.5	1.31	24.7
	1100	104	FOG2204011011310	FOG2204011011300	675	1065	1318	5.0	1.31	27.0
	1200	104	FOG2204012011310	FOG2204012011300	736	1162	1438	5.4	1.31	29.2
	1400	104	FOG2204014011310	FOG2204014011300	859	1356	1677	6.3	1.31	33.8
	1600	104	FOG2204016011300		982	1549	1917	7.2	1.31	38.3
	1800	104	FOG2204018011310	FOG2204018011300	1104	1743	2156	8.1	1.31	42.8
	2000	104	FOG2204020011310		1227	1937	2396	9.0	1.31	47.4
	2300	104	FOG2204023011310	FOG2204023011300	1411	2227	2755	10.3	1.31	54.2
	2600	104	FOG2204026011310		1595	2518	3115	11.7	1.31	7.0
	3000	104	FOG2204030011310	FOG2204030011300	1841	2905	3594	13.5	1.31	75
Typ 33										
	400	154	FOG3304004011310		338	537	666	2.7	1.32	15.3
	500	154	FOG3304005011310	FOG3304005011300	423	671	832	3.4	1.32	18.5
	600	154	FOG3304006011310		508	805	998	4.0	1.32	21.7
	700	154	FOG3304007011310	FOG3304007011300	592	939	1165	4.7	1.32	24.9



400

Höhe 400 mm	Länge	Tiefe	Artikelnummer (links)	Artikelnummer (rechts)	Systemtemperatur 55/45/20 °C	Systemtemperatur 70/55/20 °C	Systemtemperatur 75/65/20 °C	Volumen (l)	Exponent n	Gewicht (kg)
800	154		FOG3304008011310		677	1073	1331	5.4	1.32	28.7
900	154		FOG3304009011310	FOG3304009011300	761	1208	1498	6.0	1.32	31.3
1000	154		FOG3304010011310		846	1342	1664	6.7	1.32	34.4
1100	154		FOG3304011011310	FOG3304011011300	930	1476	1830	7.4	1.32	37.6
1200	154		FOG3304012011310	FOG3304012011300	1015	1610	1997	8.0	1.32	4.8
1400	154		FOG3304014011310	FOG3304014011300	1184	1878	2330	9.4	1.32	47.2
1600	154		FOG3304016011310	FOG3304016011300	1353	2147	2662	10.7	1.32	53.6
1800	154		FOG3304018011300		1523	2415	2995	12.1	1.32	59.9
2300	154		FOG3304023011310	FOG3304023011300	1946	3086	3827	15.4	1.32	75.9
2600	154		FOG3304026011310		2199	3489	4326	17.4	1.32	85.4
3000	154		FOG3304030011310	FOG3304030011300	2538	4025	4992	20.1	1.32	102.1



500

Höhe 500 mm	Länge	Tiefe	Artikelnummer (links)	Artikelnummer (rechts)	Systemtemperatur 55/45/20 °C	Systemtemperatur 70/55/20 °C	Systemtemperatur 75/65/20 °C	Volumen (l)	Exponent n	Gewicht (kg)
Typ 11										
400	62		FOG1105004010300		171	267	329	1.1	1.28	8.8
500	62		FOG1105005010310	FOG1105005010300	214	334	412	1.4	1.28	15
600	62		FOG1105006010310	FOG1105006010300	256	401	494	1.6	1.28	12.3
700	62		FOG1105007010310		299	468	576	1.9	1.28	14.6
800	62		FOG1105008010310		342	535	658	2.2	1.28	15.8
900	62		FOG1105009010310	FOG1105009010300	385	601	741	2.4	1.28	17.6
1000	62		FOG1105010010310	FOG1105010010300	427	668	823	2.7	1.28	19.3
1100	62		FOG1105011010310		470	735	905	3.0	1.28	21.1
1200	62		FOG1105012010300		513	802	988	3.2	1.28	22.9
1400	62		FOG1105014010310	FOG1105014010300	598	935	1152	3.8	1.28	26.4
1600	62		FOG1105016010310	FOG1105016010300	684	1069	1317	4.3	1.28	29.9
1800	62		FOG1105018010310	FOG1105018010300	769	1203	1481	4.9	1.28	33.4
2000	62		FOG1105020010310	FOG1105020010300	855	1336	1646	5.4	1.28	37.0
2300	62		FOG1105023010310	FOG1105023010300	983	1537	1893	6.2	1.28	42.2
2600	62		FOG1105026010310	FOG1105026010300	1111	1737	2140	7.0	1.28	47.5
3000	62		FOG1105030010310	FOG1105030010300	1282	2004	2469	8.1	1.28	54.6
Typ 21										
400	72		FOG2105004011310	FOG2105004011300	230	361	445	2.2	1.29	12.0
500	72		FOG2105005011310		288	451	557	2.8	1.29	14.6
600	72		FOG2105006011310	FOG2105006011300	345	541	668	3.3	1.29	17.5
700	72		FOG2105007011310	FOG2105007011300	403	632	779	3.9	1.29	19.6
800	72		FOG2105008011310		461	722	890	4.4	1.29	22.2
900	72		FOG2105009011310	FOG2105009011300	518	812	1002	5.0	1.29	24.6
1000	72		FOG2105010011310	FOG2105010011300	576	902	1113	5.5	1.29	27.2
1100	72		FOG2105011011300		633	993	1224	6.0	1.29	29.7



500

Höhe 500 mm	Länge	Tiefe	Artikelnummer (links)	Artikelnummer (rechts)	Systemtemperatur 55/45/20 °C	Systemtemperatur 70/55/20 °C	Systemtemperatur 75/65/20 °C	Volumen (l)	Exponent n	Gewicht (kg)
	1200	72		FOG2105012011300	691	1083	1336	6.6	1.29	32.3
	1400	72	FOG2105014011310	FOG2105014011300	806	1263	1558	7.7	1.29	37.3
	1600	72		FOG2105016011300	921	1444	1781	8.8	1.29	42.4
	1800	72	FOG2105018011310	FOG2105018011300	1036	1624	2003	9.9	1.29	47.5
	2000	72	FOG2105020011310	FOG2105020011300	1151	1805	2226	11.0	1.29	52.5
	2300	72		FOG2105023011300	1324	2076	2560	12.7	1.29	6.1
	2600	72		FOG2105026011310	1497	2346	2894	14.3	1.29	67.8
	3000	72	FOG2105030011310	FOG2105030011300	1727	2707	3339	16.5	1.29	77.9
Typ 22										
	400	104	FOG2205004011310	FOG2205004011300	294	466	578	2.2	1.32	13.7
	500	104	FOG2205005011310	FOG2205005011300	368	583	722	2.8	1.32	16.5
	600	104	FOG2205006011310	FOG2205006011300	442	699	866	3.3	1.32	19.3
	700	104	FOG2205007011310	FOG2205007011300	515	816	1011	3.9	1.32	22.2
	800	104	FOG2205008011310	FOG2205008011300	589	932	1155	4.4	1.32	25.0
	900	104	FOG2205009011310	FOG2205009011300	662	1049	1300	5.0	1.32	27.8
	1100	104	FOG2205011011310	FOG2205011011300	809	1282	1588	6.0	1.32	33.4
	1200	104	FOG2205012011310	FOG2205012011300	883	1398	1733	6.6	1.32	36.2
	1400	104		FOG2205014011310	1030	1631	2022	7.7	1.32	41.9
	1600	104	FOG2205016011310	FOG2205016011300	1177	1864	2310	8.8	1.32	47.5
	1800	104	FOG2205018011310	FOG2205018011300	1325	2097	2599	9.9	1.32	53.2
	2000	104	FOG2205020011310	FOG2205020011300	1472	2331	2888	11.0	1.32	58.8
	2300	104	FOG2205023011310	FOG2205023011300	1692	2680	3321	12.7	1.32	67.2
	3000	104	FOG2205030011310	FOG2205030011300	2208	3496	4332	16.5	1.32	87.0
Typ 33										
	400	154	FOG3305004011310	FOG3305004011300	404	642	798	3.3	1.33	18.8
	500	154	FOG3305005011310	FOG3305005011300	505	803	997	4.1	1.33	22.8



500

Höhe 500 mm	Länge	Tiefe	Artikelnummer (links)	Artikelnummer (rechts)	Systemtemperatur 55/45/20 °C	Systemtemperatur 70/55/20 °C	Systemtemperatur 75/65/20 °C	Volumen (l)	Exponent n	Gewicht (kg)
600	154		FOG3305006011310	FOG3305006011300	606	963	1196	4.9	1.33	27.0
700	154		FOG3305007011310		706	1124	1396	5.7	1.33	4.0
900	154		FOG3305009011310	FOG3305009011300	908	1445	1795	7.4	1.33	40.0
1000	154		FOG3305010011310	FOG3305010011300	1009	1606	1994	8.2	1.33	43.2
1100	154		FOG3305011011310		1110	1766	2193	9.0	1.33	47.2
1200	154		FOG3305012011310	FOG3305012011300	1211	1927	2393	9.8	1.33	51.3
1400	154		FOG3305014011310		1413	2248	2792	11.5	1.33	59.4
1600	154		FOG3305016011310	FOG3305016011300	1615	2569	3190	13.1	1.33	67.6
1800	154		FOG3305018011310	FOG3305018011300	1817	2890	3589	14.8	1.33	75.7
2300	154		FOG3305023011310	FOG3305023011300	2321	3693	4586	18.9	1.33	96.2
2600	154		FOG3305026011310	FOG3305026011300	2624	4175	5184	21.3	1.33	112.5
3000	154		FOG3305030011310	FOG3305030011300	3028	4817	5982	24.6	1.33	124.5



600

Höhe 600 mm	Länge	Tiefe	Artikelnummer (links)	Artikelnummer (rechts)	Systemtemperatur 55/45/20 °C	Systemtemperatur 70/55/20 °C	Systemtemperatur 75/65/20 °C	Volumen (l)	Exponent n	Gewicht (kg)
Typ 11										
400	62		FOG1106004010310		200	312	384	1.3	1.28	1.3
500	62		FOG1106005010310	FOG1106005010300	249	390	481	1.6	1.28	12.4
600	62		FOG1106006010310	FOG1106006010300	299	468	577	1.9	1.28	14.6
700	62		FOG1106007010310		349	546	673	2.2	1.28	16.7
800	62		FOG1106008010310		399	624	769	2.6	1.28	18.9
900	62		FOG1106009010310	FOG1106009010300	449	702	865	2.9	1.28	3.0
1000	62		FOG1106010010300		499	780	961	3.2	1.28	23.1
1100	62		FOG1106011010310	FOG1106011010300	549	858	1057	3.5	1.28	25.2
1200	62		FOG1106012010310	FOG1106012010300	599	936	1153	3.8	1.28	27.4
1400	62		FOG1106014010300		699	1092	1345	4.5	1.28	31.6
1600	62		FOG1106016010310	FOG1106016010300	798	1248	1538	5.1	1.28	35.9
1800	62		FOG1106018010310	FOG1106018010300	898	1404	1730	5.8	1.28	4.2
2600	62		FOG1106026010310	FOG1106026010300	1297	2028	2499	8.3	1.28	57.2
Typ 21										
400	72		FOG2106004011310	FOG2106004011300	266	417	515	2.6	1.30	14.4
500	72		FOG2106005011310	FOG2106005011300	332	522	644	3.3	1.30	17.5
600	72		FOG2106006011310	FOG2106006011300	398	626	773	4.0	1.30	2.5
700	72		FOG2106007011310		465	730	902	4.6	1.30	23.6
800	72		FOG2106008011310	FOG2106008011300	531	835	1030	5.3	1.30	26.6
1000	72		FOG2106010011310	FOG2106010011300	664	1043	1288	6.6	1.30	32.7
1100	72		FOG2106011011310	FOG2106011011300	731	1148	1417	7.3	1.30	35.8
1200	72		FOG2106012011310		797	1252	1546	7.9	1.30	38.8
1600	72		FOG2106016011310	FOG2106016011300	1063	1669	2061	10.6	1.30	51.1
1800	72		FOG2106018011310	FOG2106018011300	1195	1878	2318	11.9	1.30	57.1
2000	72		FOG2106020011310		1328	2087	2576	13.2	1.30	63.2



600

Höhe 600 mm	Länge	Tiefe	Artikelnummer (links)	Artikelnummer (rechts)	Systemtemperatur 55/45/20 °C	Systemtemperatur 70/55/20 °C	Systemtemperatur 75/65/20 °C	Volumen (l)	Exponent n	Gewicht (kg)
	2300	72	FOG2106023011310	FOG2106023011300	1527	2400	2962	15.2	1.30	72.4
	2600	72	FOG2106026011300		1727	2712	3349	17.2	1.30	81.5
	3000	72	FOG2106030011310		1992	3130	3864	19.8	1.30	93.7
Typ 22	400	104	FOG2206004011310	FOG2206004011300	340	540	670	2.6	1.33	16.4
	500	104	FOG2206005011310	FOG2206005011300	425	675	838	3.3	1.33	19.8
	600	104	FOG2206006011310		510	810	1006	4.0	1.33	23.3
	700	104	FOG2206007011310	FOG2206007011300	595	945	1173	4.6	1.33	26.7
	800	104	FOG2206008011310	FOG2206008011300	680	1080	1341	5.3	1.33	3.2
	900	104	FOG2206009011300		765	1215	1508	5.9	1.33	33.7
	1000	104	FOG2206010011300		850	1350	1676	6.6	1.33	37.1
	1100	104	FOG2206011011300		935	1485	1844	7.3	1.33	4.6
	1200	104	FOG2206012011310		1020	1620	2011	7.9	1.33	44.2
	1400	104	FOG2206014011310	FOG2206014011300	1190	1890	2346	9.2	1.33	5.9
	1600	104	FOG2206016011310		1360	2161	2682	10.6	1.33	57.8
	1800	104	FOG2206018011310	FOG2206018011300	1530	2431	3017	11.9	1.33	64.7
	2000	104	FOG2206020011310	FOG2206020011300	1700	2701	3352	13.2	1.33	71.7
	2300	104	FOG2206023011310	FOG2206023011300	1955	3106	3855	15.2	1.33	82.3
	2600	104	FOG2206026011310	FOG2206026011300	2210	3511	4358	17.2	1.33	92.4
	3000	104	FOG2206030011310		2549	4051	5028	19.8	1.33	110.4
Typ 33	500	154	FOG3306005011310		582	928	1155	4.9	1.34	27.4
	600	154	FOG3306006011310	FOG3306006011300	698	1114	1385	5.9	1.34	32.2
	700	154	FOG3306007011310		814	1300	1616	6.9	1.34	37.9
	800	154	FOG3306008011310	FOG3306008011300	931	1485	1847	7.8	1.34	42.0
	900	154	FOG3306009011310	FOG3306009011300	1047	1671	2078	8.8	1.34	46.8



600

Höhe 600 mm	Länge	Tiefe	Artikelnummer (links)	Artikelnummer (rechts)	Systemtemperatur 55/45/20 °C	Systemtemperatur 70/55/20 °C	Systemtemperatur 75/65/20 °C	Volumen (l)	Exponent n	Gewicht (kg)
1000	154		FOG3306010011310	FOG3306010011300	1164	1857	2309	9.8	1.34	51.7
1100	154			FOG3306011011310	1280	2042	2540	10.8	1.34	56.6
1200	154			FOG3306012011300	1396	2228	2771	11.8	1.34	61.4
1400	154			FOG3306014011300	1629	2599	3233	13.7	1.34	71.2
1600	154			FOG3306016011300	1862	2971	3694	15.7	1.34	8.9
1800	154		FOG3306018011310	FOG3306018011300	2094	3342	4156	17.6	1.34	9.7
2000	154			FOG3306020011310	2327	3713	4618	19.6	1.34	14
2300	154			FOG3306023011300	2676	4270	5311	22.5	1.34	115.1
2600	154		FOG3306026011310	FOG3306026011300	3025	4827	6003	25.5	1.34	129.6
3000	154			FOG3306030011310	3491	5570	6927	29.4	1.34	149.9



900

Höhe 900 mm	Länge	Tiefe	Artikelnummer (links)	Artikelnummer (rechts)	Systemtemperatur 55/45/20 °C	Systemtemperatur 70/55/20 °C	Systemtemperatur 75/65/20 °C	Volumen (l)	Exponent n	Gewicht (kg)
Typ 11										
400	62		FOG1109004010310	FOG1109004010300	277	436	539	1.8	1.30	14.9
500	62		FOG1109005010300		346	545	674	2.3	1.30	18.2
600	62		FOG1109006010300		416	654	808	2.7	1.30	21.4
700	62		FOG1109007010300		485	763	943	3.1	1.30	24.6
800	62		FOG1109008010310	FOG1109008010300	554	872	1078	3.6	1.30	27.9
900	62		FOG1109009010310	FOG1109009010300	624	981	1212	4.0	1.30	32.4
1000	62		FOG1109010010310		693	1090	1347	4.5	1.30	34.3
1100	62		FOG1109011010310	FOG1109011010300	762	1199	1482	5.0	1.30	37.6
1400	62		FOG1109014010310	FOG1109014010300	970	1526	1886	6.3	1.30	47.3
1600	62		FOG1109016010300		1109	1744	2155	7.2	1.30	53.8
1800	62		FOG1109018010310	FOG1109018010300	1247	1962	2425	8.1	1.30	6.2
2000	62		FOG1109020010310	FOG1109020010300	1386	2180	2694	9.0	1.30	66.7
Typ 21										
400	72		FOG2109004011300		357	568	706	3.6	1.34	2.9
500	72		FOG2109005011300		446	710	883	4.5	1.34	25.5
600	72		FOG2109006011310	FOG2109006011300	535	852	1059	5.4	1.34	3.2
700	72		FOG2109007011310	FOG2109007011300	624	994	1236	6.3	1.34	34.8
800	72		FOG2109008011310	FOG2109008011300	713	1136	1412	7.2	1.34	39.4
900	72		FOG2109009011310	FOG2109009011300	802	1278	1589	8.1	1.34	44.1
1000	72		FOG2109010011300		891	1420	1765	9.0	1.34	48.7
1100	72		FOG2109011011300		981	1562	1942	9.9	1.34	53.4
1200	72		FOG2109012011310	FOG2109012011300	1070	1704	2118	10.8	1.34	58.4
1400	72		FOG2109014011310	FOG2109014011300	1248	1988	2471	12.6	1.34	67.3
1600	72		FOG2109016011300		1426	2272	2824	14.4	1.34	76.6
1800	72		FOG2109018011310		1605	2556	3177	16.2	1.34	85.9



900

Höhe 900 mm	Länge	Tiefe	Artikelnummer (links)	Artikelnummer (rechts)	Systemtemperatur 55/45/20 °C	Systemtemperatur 70/55/20 °C	Systemtemperatur 75/65/20 °C	Volumen (l)	Exponent n	Gewicht (kg)
	2000	72	FOG2109020011310	FOG2109020011300	1783	2841	3530	18.0	1.34	95.2
Typ 22										
	400	104	FOG2209004011310	FOG2209004011300	462	739	920	3.6	1.35	23.9
	500	104	FOG2209005011310	FOG2209005011300	578	924	1151	4.5	1.35	28.9
	600	104	FOG2209006011310	FOG2209006011300	693	1109	1381	5.4	1.35	34.9
	700	104	FOG2209007011310	FOG2209007011300	809	1294	1611	6.3	1.35	39.2
	800	104	FOG2209008011310	FOG2209008011300	924	1478	1841	7.2	1.35	44.4
	900	104	FOG2209009011310		1040	1663	2071	8.1	1.35	49.5
	1000	104	FOG2209010011310	FOG2209010011300	1155	1848	2301	9.0	1.35	54.6
	1100	104	FOG2209011011310		1271	2033	2531	9.9	1.35	59.8
	1200	104	FOG2209012011310	FOG2209012011300	1386	2218	2761	10.8	1.35	64.9
	1400	104	FOG2209014011310	FOG2209014011300	1617	2587	3221	12.6	1.35	75.2
	1600	104	FOG2209016011310		1848	2957	3682	14.4	1.35	85.5
	1800	104	FOG2209018011310	FOG2209018011300	2080	3327	4142	16.2	1.35	95.7
	2000	104	FOG2209020011310	FOG2209020011300	2311	3696	4602	18.0	1.35	110.2
Typ 33										
	400	154	FOG3309004011310	FOG3309004011300	633	1017	1268	5.3	1.36	33.8
	500	154	FOG3309005011310		791	1271	1586	6.7	1.36	4.4
	600	154	FOG3309006011310	FOG3309006011300	949	1525	1903	8.0	1.36	47.8
	700	154	FOG3309007011310	FOG3309007011300	1107	1779	2220	9.3	1.36	55.2
	800	154	FOG3309008011310	FOG3309008011300	1266	2033	2537	10.6	1.36	62.6
	900	154	FOG3309009011310	FOG3309009011300	1424	2288	2854	12.0	1.36	69.9
	1000	154	FOG3309010011310		1582	2542	3171	13.3	1.36	77.3
	1100	154	FOG3309011011310	FOG3309011011300	1740	2796	3488	14.6	1.36	84.7
	1200	154	FOG3309012011310	FOG3309012011300	1898	3050	3805	16.0	1.36	92.6
	1400	154	FOG3309014011310		2215	3558	4439	18.6	1.36	111.1



900

Höhe 900 mm	Länge	Tiefe	Artikelnummer (links)	Artikelnummer (rechts)	Systemtemperatur 55/45/20 °C	Systemtemperatur 70/55/20 °C	Systemtemperatur 75/65/20 °C	Volumen (l)	Exponent n	Gewicht (kg)
1600	154		FOG3309016011310	FOG3309016011300	2531	4067	5074	21.3	1.36	121.5
1800	154		FOG3309018011310	FOG3309018011300	2848	4575	5708	23.9	1.36	136.3
2000	154		FOG3309020011310	FOG3309020011300	3164	5083	6342	26.6	1.36	151.3