



Datenblatt

2026-06-07

Plan Ventil Compact

Der Plan Ventil Compact ist ein klassischer Kompaktheizkörper mit ...



- ✓ Plane Vorderfront
- ✓ flexible Anschlußmöglichkeiten
- ✓ 6 Anschlüsse (4xseitlich, 2x unten)
- ✓ Große Vielfalt an Bauhöhen und -tiefen
- ✓ Verschiedene Größenoptionen

Der **Plan Ventil Compact** ist ein klassischer Kompaktheizkörper mit flacher, glatter Front für geschlossene warmwasserbasierte Heizsysteme. Sein integrierter Ventilanschluss und sein flaches Profil ermöglichen eine attraktive und einfache Installation. Die Beschichtung ist standardmäßig weiß - RAL 9016.



Anwendungsbereich

Der Plan Ventil Compact ist ein klassischer Kompaktheizkörper mit flacher, glatter Front für geschlossene warmwasserbasierte Heizsysteme. Sein integrierter Ventilanschluss und sein flaches Profil ermöglichen eine attraktive und einfache Installation. Die Beschichtung ist standardmäßig weiß - RAL 9016.

Dimensionierung

Für die richtige Produktauswahl oder weitere Infos nutzen Sie bitte unsere technischen Unterlagen, Produkthandbücher, unseren Planungsservice oder kontaktieren Sie uns via E-Mail oder Telefon.

Verwendung

Der Plan Ventil Compact ist ein klassischer Kompaktheizkörper mit flacher, glatter Front für geschlossene warmwasserbasierte Heizsysteme. Sein integrierter Ventilanschluss und sein flaches Profil ermöglichen eine attraktive und einfache Installation. Die Beschichtung ist standardmäßig weiß - RAL 9016.

Ausschreibungstext

Plan Ventil Compact 6-Muffen-Planheizkörper ohne Laschenaufhängung Typen 21 S, 22, 33 und 44, Standard Rechtsanschluss, mit Laschenaufhängung Typ 11, Standard Rechtsanschluss

Fertiglackierter, mit Epoxydharzpulver beschichteter Heizkörper aus Stahlblech DC01 nach EN 10130 und EN 10131, Blechdicke gemäß Anforderungen der EN 442-1, mit einseitiger, verzinkter Planfront, zur Anwendung in Warmwasserheizungsanlagen nach DIN 4751.

Entfettet, phosphatiert, im KTL-Verfahren tauchgrundiert und pulverbeschichtet nach DIN 55 900.

Wärmeleistung gemäß EN 442 und bei WSP-CERT registriert.

RAL-Gütezeichen, 10 Jahre Garantie

Montageverpackt, mit Pappkantenschutz, Pappschutzecken und Schrumpffolie.

Mit integrierter Ventilgarnitur und serienmäßig voreinstellbarem Ventileinsatz (Regelbereich 0,05-0,70 m³/h) zum Anbau von Thermostat-Ventilköpfen. Ventileinsatz leistungsmäßig werkseitig voreingestellt und farbig gekennzeichnet Ventilgarnitur werkseitig für 2-Rohr-Betrieb, Anschlussmöglichkeit von unten über

entsprechende Anschlussverschraubungen. Anschluss seitlich 4 x G ½" möglich.

Mit Zierabdeckung und Seitenverkleidungen, ab Baulänge 1800 mm mit zusätzlicher Befestigung der Zierabdeckung fertig montiert.

Bauhöhe 200 mm ohne Befestigung; Bauhöhen 300 bis 900 mm einschließlich FZ-Halterung (VDI 6036, AK2) mit Schallschutzeinlage inkl. Aushebesicherung für Typen 21S, 22 + 33 bzw. Schnellmontage-Set (VDI 6036, AK2) mit Aushebesicherungen und Schallschutzeinlagen für Typ 11, inkl. Schrauben und Dübel.

Ventileinsatz ½", Blind- und Entlüftungsstopfen werkseitig montiert.

Ventilgarnitur standardmäßig rechts, auf Wunsch als Sonderanfertigung links ohne Mehrpreis lieferbar

Farbe: RAL 9016, weitere RAL Farben auf Anfrage

Betriebsdruck: 10 bar

Prüfdruck: 13 bar

Temperatur: max. 110° C

Medium: Wasser

Anschlüsse: 2 x G ½" unten, 4 x G ½" seitlich, nach ISO 228

Typen:10-E, 11-EK; 21S-EKE schmal; 22-DK; 33-DKEK, 44-EKDKEK(BH 200)

Bauhöhen: 200, 300, 400, 500, 600, 900 mm

Baulängen: 400...3000 mm (BH 900: bis 2000 mm)

Liefernachweis: PG Germany GmbH · Lierestraße 68 · 38690 Goslar

Telefon (0 53 24) 8 08-0 · Telefax (0 53 24) 8 08-999

Stück Typ: 10-E, Planheizkörper, ohne Zierabdeckung und Seitenverkleidung - liefern

Bauhöhe:mm; Baulänge:mm - montieren

Stück Typ: 11-EK, Ventil-Kompaktheizkörper - liefern

Bauhöhe:.....mm; Baulänge:mm - montieren

Stück Typ: 21S-EKE schmal, Ventil-Kompaktheizkörper - liefern

Bauhöhe:.....mm; Baulänge:mm - montieren

Stück Typ: 22-DK, Ventil-Kompaktheizkörper - liefern

Bauhöhe:mm; Baulänge:mm - montieren

Stück Typ: 33-DKEK, Ventil-Kompaktheizkörper - liefern

Bauhöhe:mm; Baulänge:mm - montieren

Stück Typ: 44-EKDKEK, Ventil-Kompaktheizkörper - liefern

Bauhöhe:mm; Baulänge:mm - montieren





Spezifikationen

EIGENSCHAFTEN	EINHEIT	WERTE
ETIM-Klasse		EC011022
Material		Stahl
Typ		11, 21, 22, 33
Bauart		flach glatt
Maximaler Betriebsdruck	bar	10
Anzahl der Standardanschlüsse		2
Wärmeleistung nach DIN EN 442 zertifiziert		Ja
Max. Betriebstemperatur	°C	110
Standardfarbe		Ja
Farbe		weiß
RAL-Nummer		9016
Zierritter		Ja
Seitenteile		Ja
Glanzgrad		glänzend
Gewindemaß (Zoll)		1/2 Zoll
Gewindeanschluss		Innengewinde
Mit Einpunktanschluss		Ja
Mit Entlüftungsanschluss		Ja
Mit Entlüftungsventil		Ja
Mit Entleerungsmöglichkeit		Ja



Dokumente

DOKUMENTE	DOKUMENTENTYP	LINK
Gesamtprospekt Purmo Produktkatalog	ProductCatalog	https://asset.productmarketingcloud.com/api/assetstorage/3577_2fa18b7b-6b77-472f-80d4-925ab66fb184
Garantiebedingungen Heizkörper, Konvektoren und andere Komponenten	Warranty	https://asset.productmarketingcloud.com/api/assetstorage/3577_0b2455b1-4f72-4336-9409-00a3bb24227d
Montageanleitung FZ-Halterungen für Flachheizkörper	Installation	https://asset.productmarketingcloud.com/api/assetstorage/3577_40b8e51f-c96a-48bf-80ee-9adbe248dcac
Montageanleitung Schnellmontage- Set	Installation	https://asset.productmarketingcloud.com/api/assetstorage/3577_a03319f4-b913-485e-8b9e-437f1dde6ab3
Montageanleitung Standkonsole BH 300-900 mm	Installation	https://asset.productmarketingcloud.com/api/assetstorage/3577_73b1b432-1a36-40d5-944f-9374edb49a53
Leistungskalkulator Flachheizkörper	TechDia	https://asset.productmarketingcloud.com/api/assetstorage/3577_2da398bb-5820-4a58-af2d-62333aa4e65e



Ressourcen

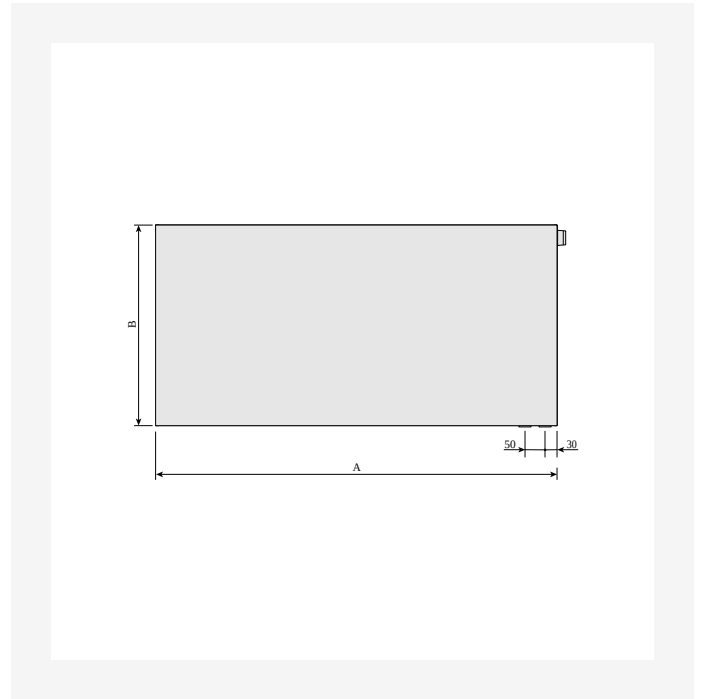

ProductImage - Panel radiator Plan Ventil Compact, FCV, with flat front.

DimensionalDrawing - Plan Ventil Compact, front view right

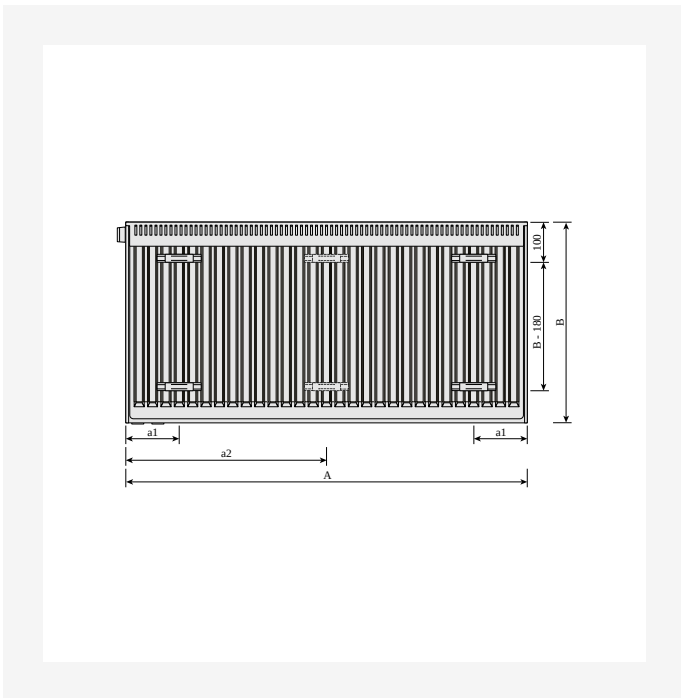

PLAN VENTIL COMPACT (mm)		
	FCV11	
A	a1	a2
400-1600	117	-
1800	117	917
2000	117	1017
2300	117	1150
2600	117	1317
3000	117	1517

DimensionalDrawing - Plan Ventil Compact, back view

DimensionalDrawing - Plan-Ventil-Compact-table-drawings a



Ressourcen

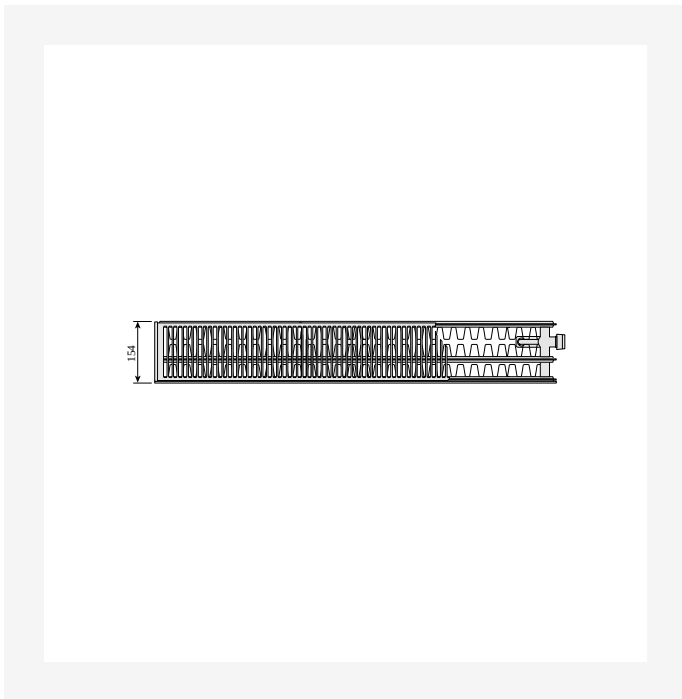

DimensionalDrawing - Plan Ventil Compact and Ramo Ventil Compact, type 33 right, top view

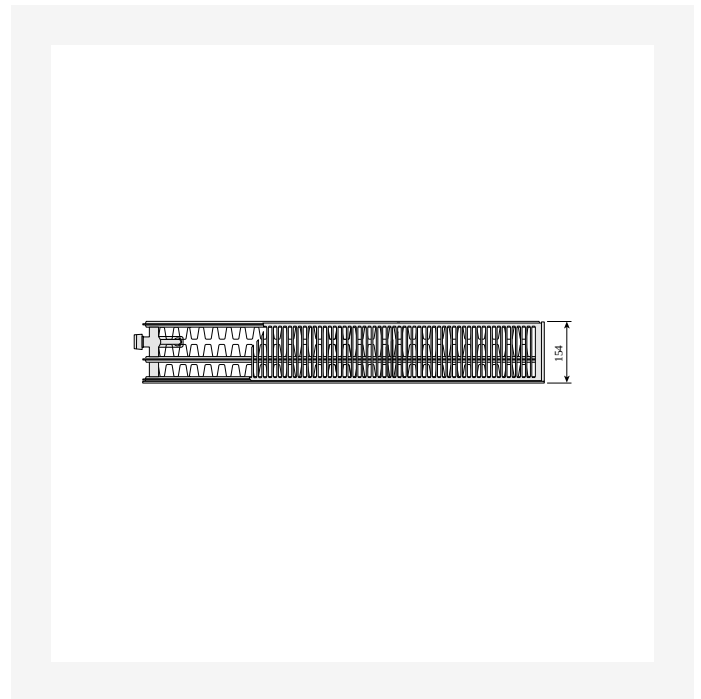

DimensionalDrawing - Plan Ventil Compact and Ramo Ventil Compact, type 33 left, top view

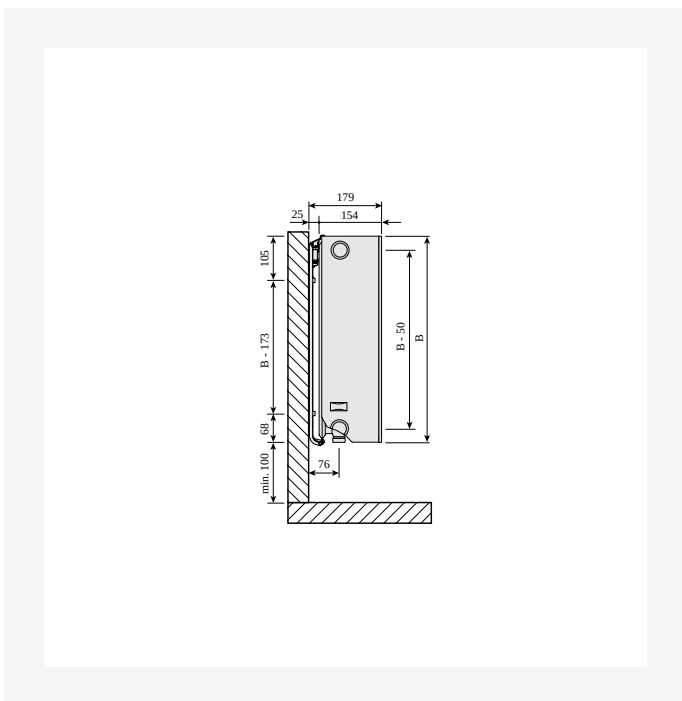

DimensionalDrawing - Plan Ventil Compact and Ramo Ventil Compact, types 30-33, side view



DimensionalDrawing - Plan Ventil Compact and Ramo Ventil Compact, type 22 right, top view



Ressourcen

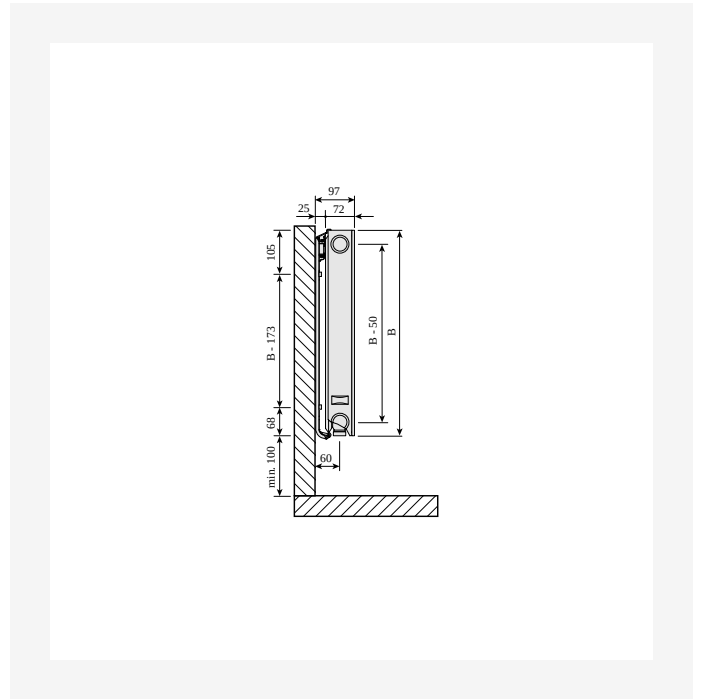
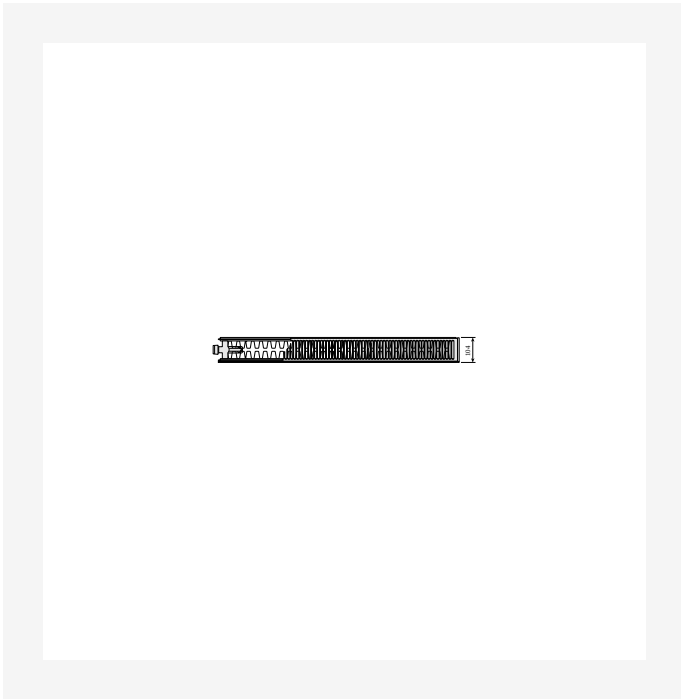

DimensionalDrawing - Plan Ventil Compact and Ramo Ventil Compact, type 22 left, top view

DimensionalDrawing - Plan Ventil Compact and Ramo Ventil Compact, type 21s, side view

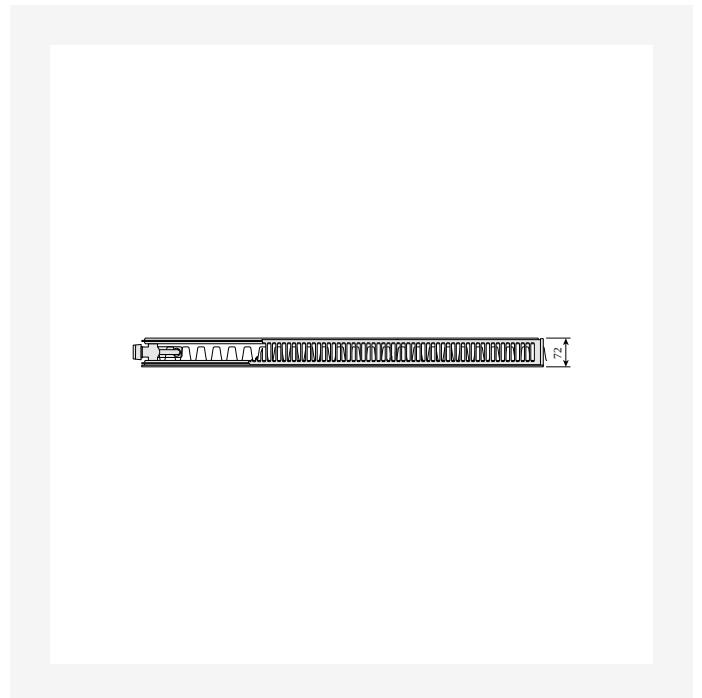
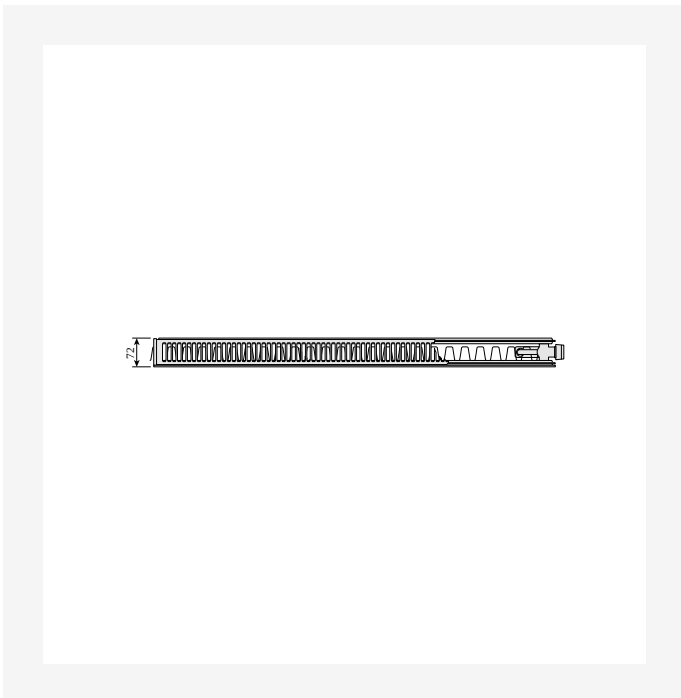

DimensionalDrawing - Plan Ventil Compact and Ramo Ventil Compact, type 21s right, top view

DimensionalDrawing - Plan Ventil Compact and Ramo Ventil Compact, type 21s left, top view



Ressourcen

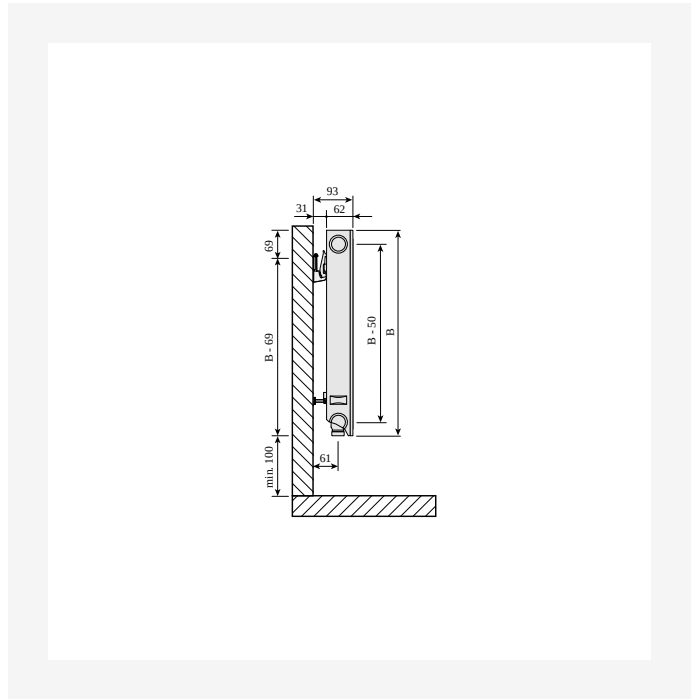
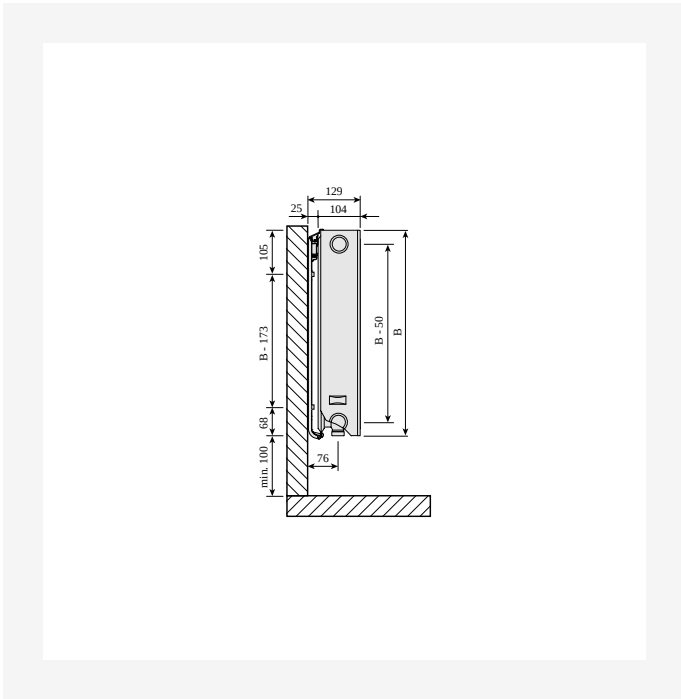

DimensionalDrawing - Plan Ventil Compact and Ramo Ventil Compact types 20-22, side view

DimensionalDrawing - Plan Ventil Compact and Ramo Ventil Compact type 11, side view

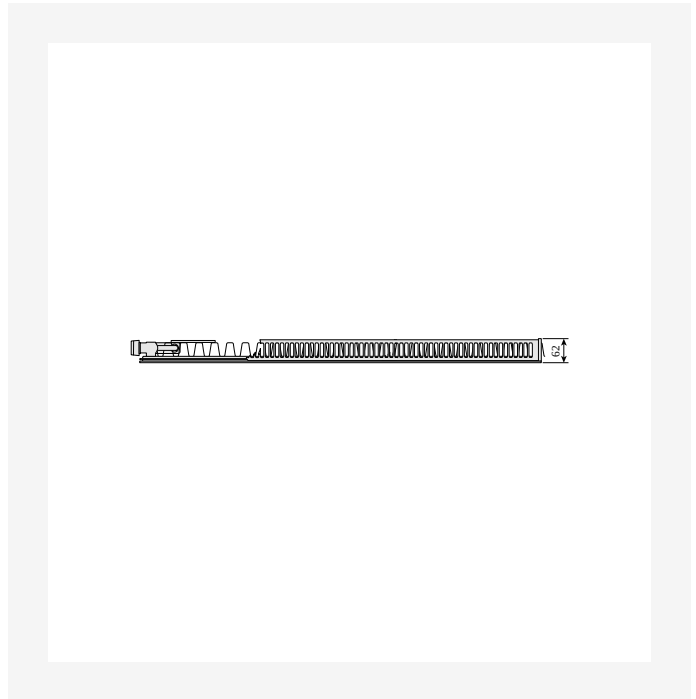
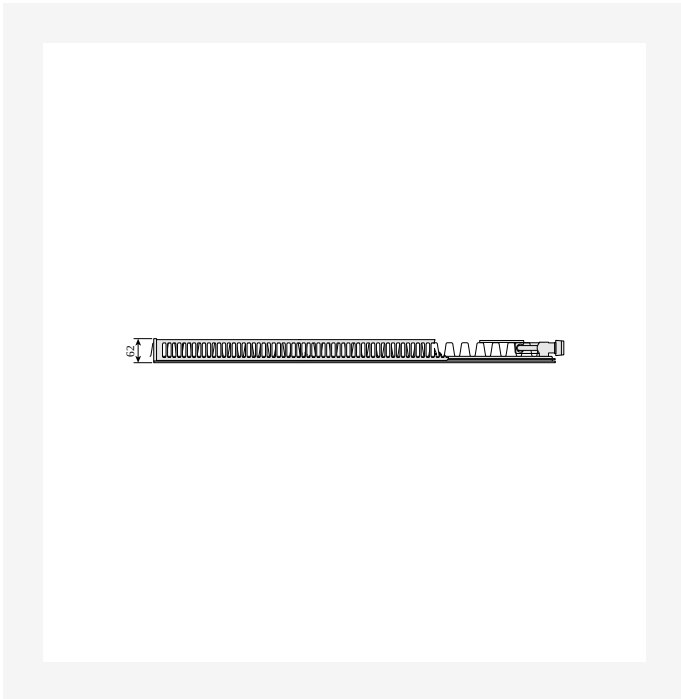

DimensionalDrawing - Plan Ventil Compact and Ramo Ventil Compact, type 11 right, top view

DimensionalDrawing - Plan Ventil Compact and Ramo Ventil Compact type 11 left, top view



Ressourcen

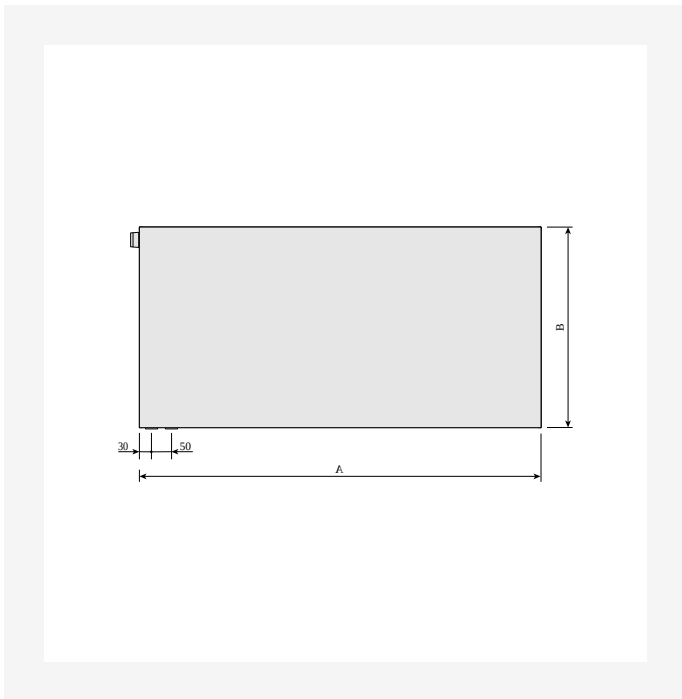

DimensionalDrawing - Plan Ventil Compact, front view left



Verwandte Produkte



Zierabdeckung



Seitenteil
Kompaktheizkörper



300

Höhe 300 mm	Länge	Tiefe	Artikelnummer (links)	Artikelnummer (rechts)	Systemtemperatur 55/45/20 °C	Systemtemperatur 70/55/20 °C	Systemtemperatur 75/65/20 °C	Volumen (l)	Exponent n	Gewicht (kg)
Typ 11										
400	62		FOA1103004010310	FOA1103004010300	110	172	212	0.7	1.28	5.6
500	62		FOA1103005010310		137	215	265	0.8	1.28	6.7
600	62		FOA1103006010310	FOA1103006010300	165	258	317	1.0	1.28	7.7
700	62		FOA1103007010310	FOA1103007010300	192	301	370	1.2	1.28	8.8
800	62		FOA1103008010310		220	344	423	1.4	1.28	10.2
900	62		FOA1103009010310		247	387	476	1.5	1.28	1.9
1000	62		FOA1103010010310	FOA1103010010300	275	430	529	1.7	1.28	11.9
1100	62		FOA1103011010310	FOA1103011010300	302	472	582	1.9	1.28	13.1
1200	62		FOA1103012010310		330	515	635	2.0	1.28	14.6
1400	62		FOA1103014010300		385	601	741	2.4	1.28	16.2
1600	62		FOA1103016010310	FOA1103016010300	440	687	846	2.7	1.28	18.3
1800	62		FOA1103018010310	FOA1103018010300	495	773	952	3.1	1.28	2.4
2000	62		FOA1103020010310	FOA1103020010300	550	859	1058	3.4	1.28	22.5
2300	62		FOA1103023010300		632	988	1217	3.9	1.28	25.8
2600	62		FOA1103026010310		715	1117	1375	4.4	1.28	28.9
3000	62		FOA1103030010310	FOA1103030010300	824	1289	1587	5.1	1.28	33.1
Typ 21										
400	72		FOA2103004011300		152	238	293	1.4	1.28	7.6
500	72		FOA2103005011310	FOA2103005011300	190	297	366	1.7	1.28	9.2
700	72		FOA2103007011310	FOA2103007011300	267	416	512	2.4	1.28	12.2
800	72		FOA2103008011310		305	476	586	2.7	1.28	13.7
900	72		FOA2103009011310	FOA2103009011300	343	535	659	3.1	1.28	15.2
1000	72		FOA2103010011310	FOA2103010011300	381	595	732	3.4	1.28	16.7
1100	72		FOA2103011011300		419	654	805	3.7	1.28	18.2



300

Höhe 300 mm	Länge	Tiefe	Artikelnummer (links)	Artikelnummer (rechts)	Systemtemperatur 55/45/20 °C	Systemtemperatur 70/55/20 °C	Systemtemperatur 75/65/20 °C	Volumen (l)	Exponent n	Gewicht (kg)
1400	72		FOA2103014011310	FOA2103014011300	533	833	1025	4.8	1.28	22.7
1600	72		FOA2103016011310		610	951	1171	5.4	1.28	25.8
1800	72		FOA2103018011300		686	1070	1318	6.1	1.28	28.8
2000	72		FOA2103020011310	FOA2103020011300	762	1189	1464	6.8	1.28	31.8
2300	72		FOA2103023011310	FOA2103023011300	876	1368	1684	7.8	1.28	36.3
2600	72		FOA2103026011310	FOA2103026011300	990	1546	1903	8.8	1.28	4.9
3000	72		FOA2103030011310	FOA2103030011300	1143	1784	2196	10.2	1.28	46.9

Typ 22

400	104		FOA2203004011310	FOA2203004011300	193	303	375	1.4	1.30	8.6
500	104		FOA2203005011300		241	379	469	1.7	1.30	1.2
600	104		FOA2203006011310	FOA2203006011300	289	455	562	2.0	1.30	11.9
700	104		FOA2203007011310		338	531	656	2.4	1.30	13.6
800	104		FOA2203008011310		386	607	750	2.7	1.30	15.2
900	104		FOA2203009011300		434	683	843	3.1	1.30	16.9
1000	104		FOA2203010011310	FOA2203010011300	482	759	937	3.4	1.30	18.5
1100	104		FOA2203011011310		531	834	1031	3.7	1.30	2.2
1200	104		FOA2203012011310	FOA2203012011300	579	910	1124	4.1	1.30	21.9
1400	104		FOA2203014011310	FOA2203014011300	675	1062	1312	4.8	1.30	25.2
1600	104		FOA2203016011310	FOA2203016011300	772	1214	1499	5.4	1.30	28.5
1800	104		FOA2203018011300		868	1365	1687	6.1	1.30	31.8
2000	104		FOA2203020011310	FOA2203020011300	965	1517	1874	6.8	1.30	35.1
2300	104		FOA2203023011300		1109	1745	2155	7.8	1.30	4.1
2600	104		FOA2203026011300		1254	1972	2436	8.8	1.30	45.1
3000	104		FOA2203030011310	FOA2203030011300	1447	2276	2811	10.2	1.30	51.8

Typ 33

400	154		FOA3303004011300		268	424	526	2.0	1.32	11.7
-----	-----	--	------------------	--	-----	-----	-----	-----	------	------



300

Höhe 300 mm	Länge	Tiefe	Artikelnummer (links)	Artikelnummer (rechts)	Systemtemperatur 55/45/20 °C	Systemtemperatur 70/55/20 °C	Systemtemperatur 75/65/20 °C	Volumen (l)	Exponent n	Gewicht (kg)
500	154		FOA3303005011310		335	531	657	2.5	1.32	14.5
600	154		FOA3303006011310	FOA3303006011300	403	637	788	3.1	1.32	16.4
700	154		FOA3303007011310	FOA3303007011300	470	743	920	3.6	1.32	18.8
800	154		FOA3303008011310		537	849	1051	4.1	1.32	21.2
900	154		FOA3303009011310	FOA3303009011300	604	955	1183	4.6	1.32	23.5
1000	154		FOA3303010011310	FOA3303010011300	671	1061	1314	5.1	1.32	25.9
1100	154		FOA3303011011310		738	1167	1445	5.6	1.32	28.3
1200	154		FOA3303012011310	FOA3303012011300	805	1273	1577	6.1	1.32	3.6
1600	154		FOA3303016011310	FOA3303016011300	1073	1698	2102	8.2	1.32	4.1
1800	154		FOA3303018011300		1208	1910	2365	9.2	1.32	44.9
2000	154		FOA3303020011310	FOA3303020011300	1342	2122	2628	10.2	1.32	49.6
2300	154		FOA3303023011310	FOA3303023011300	1543	2440	3022	11.7	1.32	56.8
2600	154		FOA3303026011310	FOA3303026011300	1744	2759	3416	13.3	1.32	63.8
3000	154		FOA3303030011310	FOA3303030011300	2013	3183	3942	15.3	1.32	73.3



400

Höhe 400 mm	Länge	Tiefe	Artikelnummer (links)	Artikelnummer (rechts)	Systemtemperatur 55/45/20 °C	Systemtemperatur 70/55/20 °C	Systemtemperatur 75/65/20 °C	Volumen (l)	Exponent n	Gewicht (kg)
Typ 11										
400	62		FOA1104004010310		141	221	272	0.9	1.28	7.4
500	62		FOA1104005010310	FOA1104005010300	177	276	340	1.1	1.28	8.5
600	62		FOA1104006010310		212	331	408	1.3	1.28	10.4
700	62		FOA1104007010310	FOA1104007010300	247	386	476	1.5	1.28	11.4
800	62		FOA1104008010310	FOA1104008010300	283	442	544	1.8	1.28	12.8
1000	62		FOA1104010010310	FOA1104010010300	353	552	680	2.2	1.28	15.7
1100	62		FOA1104011010310	FOA1104011010300	389	607	748	2.4	1.28	17.1
1200	62		FOA1104012010310	FOA1104012010300	424	662	816	2.6	1.28	18.6
1600	62		FOA1104016010310		565	883	1088	3.5	1.28	24.3
1800	62		FOA1104018010310	FOA1104018010300	636	994	1224	4.0	1.28	27.2
2000	62		FOA1104020010310	FOA1104020010300	706	1104	1360	4.4	1.28	3.2
2300	62		FOA1104023010310	FOA1104023010300	812	1270	1564	5.1	1.28	34.3
2600	62		FOA1104026010310	FOA1104026010300	918	1435	1768	5.7	1.28	38.6
3000	62		FOA1104030010310	FOA1104030010300	1060	1656	2040	6.6	1.28	44.4
Typ 21										
400	72		FOA2104004011300		193	302	372	1.8	1.28	10.4
500	72		FOA2104005011310	FOA2104005011300	241	377	465	2.3	1.28	12.0
700	72		FOA2104007011310	FOA2104007011300	337	528	650	3.1	1.28	16.0
800	72		FOA2104008011310	FOA2104008011300	386	603	743	3.6	1.28	18.0
1000	72		FOA2104010011310	FOA2104010011300	482	754	929	4.5	1.28	22.0
1100	72		FOA2104011011310	FOA2104011011300	530	829	1022	5.0	1.28	24.0
1200	72		FOA2104012011310	FOA2104012011300	578	905	1115	5.4	1.28	26.0
1400	72		FOA2104014011310	FOA2104014011300	675	1056	1301	6.3	1.28	30.0
1600	72		FOA2104016011310	FOA2104016011300	771	1206	1486	7.2	1.28	34.0
1800	72		FOA2104018011310	FOA2104018011300	868	1357	1672	8.1	1.28	38.3



400

Höhe 400 mm	Länge	Tiefe	Artikelnummer (links)	Artikelnummer (rechts)	Systemtemperatur 55/45/20 °C	Systemtemperatur 70/55/20 °C	Systemtemperatur 75/65/20 °C	Volumen (l)	Exponent n	Gewicht (kg)
	2000	72		FOA2104020011310	964	1508	1858	9.0	1.28	42.5
	2300	72		FOA2104023011300	1109	1734	2137	10.3	1.28	48.8
	2600	72		FOA2104026011300	1253	1960	2415	11.7	1.28	54.2
	3000	72	FOA2104030011310	FOA2104030011300	1446	2262	2787	13.5	1.28	62.3
Typ 22										
	400	104		FOA2204004011310	245	387	479	1.8	1.31	11.5
	500	104	FOA2204005011310	FOA2204005011300	307	484	599	2.3	1.31	13.4
	600	104	FOA2204006011310	FOA2204006011300	368	581	719	2.7	1.31	15.6
	700	104		FOA2204007011310	430	678	839	3.1	1.31	17.9
	800	104	FOA2204008011310	FOA2204008011300	491	775	958	3.6	1.31	2.2
	900	104	FOA2204009011310	FOA2204009011300	552	871	1078	4.0	1.31	22.4
	1000	104	FOA2204010011310	FOA2204010011300	614	968	1198	4.5	1.31	24.7
	1100	104		FOA2204011011310	675	1065	1318	5.0	1.31	27.0
	1200	104	FOA2204012011310	FOA2204012011300	736	1162	1438	5.4	1.31	29.2
	1400	104		FOA2204014011300	859	1356	1677	6.3	1.31	33.8
	1600	104	FOA2204016011310	FOA2204016011300	982	1549	1917	7.2	1.31	38.3
	1800	104	FOA2204018011310	FOA2204018011300	1104	1743	2156	8.1	1.31	42.8
	2000	104		FOA2204020011310	1227	1937	2396	9.0	1.31	47.4
	2600	104		FOA2204026011310	1595	2518	3115	11.7	1.31	7.0
Typ 33										
	400	154	FOA3304004011310	FOA3304004011300	338	537	666	2.7	1.32	15.3
	500	154		FOA3304005011300	423	671	832	3.4	1.32	18.5
	600	154	FOA3304006011310	FOA3304006011300	508	805	998	4.0	1.32	21.7
	700	154	FOA3304007011310	FOA3304007011300	592	939	1165	4.7	1.32	24.9
	800	154	FOA3304008011310	FOA3304008011300	677	1073	1331	5.4	1.32	28.7
	900	154		FOA3304009011300	761	1208	1498	6.0	1.32	31.3



400

Höhe 400 mm	Länge	Tiefe	Artikelnummer (links)	Artikelnummer (rechts)	Systemtemperatur 55/45/20 °C	Systemtemperatur 70/55/20 °C	Systemtemperatur 75/65/20 °C	Volumen (l)	Exponent n	Gewicht (kg)
1000	154		FOA3304010011310	FOA3304010011300	846	1342	1664	6.7	1.32	34.4
1100	154		FOA3304011011310	FOA3304011011300	930	1476	1830	7.4	1.32	37.6
1200	154		FOA3304012011310	FOA3304012011300	1015	1610	1997	8.0	1.32	4.8
1400	154		FOA3304014011310	FOA3304014011300	1184	1878	2330	9.4	1.32	47.2
1600	154		FOA3304016011310	FOA3304016011300	1353	2147	2662	10.7	1.32	53.6
1800	154		FOA3304018011310	FOA3304018011300	1523	2415	2995	12.1	1.32	59.9
2000	154		FOA3304020011310		1692	2683	3328	13.4	1.32	66.3
2300	154		FOA3304023011310	FOA3304023011300	1946	3086	3827	15.4	1.32	75.9
2600	154		FOA3304026011310		2199	3489	4326	17.4	1.32	85.4
3000	154		FOA3304030011310	FOA3304030011300	2538	4025	4992	20.1	1.32	102.1



500

Höhe 500 mm	Länge	Tiefe	Artikelnummer (links)	Artikelnummer (rechts)	Systemtemperatur 55/45/20 °C	Systemtemperatur 70/55/20 °C	Systemtemperatur 75/65/20 °C	Volumen (l)	Exponent n	Gewicht (kg)
Typ 11										
400	62		FOA1105004010310	FOA1105004010300	171	267	329	1.1	1.28	8.8
500	62		FOA1105005010310	FOA1105005010300	214	334	412	1.4	1.28	15
600	62		FOA1105006010310		256	401	494	1.6	1.28	12.3
700	62		FOA1105007010310	FOA1105007010300	299	468	576	1.9	1.28	14.6
1000	62		FOA1105010010310	FOA1105010010300	427	668	823	2.7	1.28	19.3
1100	62		FOA1105011010310	FOA1105011010300	470	735	905	3.0	1.28	21.1
1200	62		FOA1105012010310	FOA1105012010300	513	802	988	3.2	1.28	22.9
1400	62		FOA1105014010300		598	935	1152	3.8	1.28	26.4
1600	62		FOA1105016010310	FOA1105016010300	684	1069	1317	4.3	1.28	29.9
1800	62		FOA1105018010310	FOA1105018010300	769	1203	1481	4.9	1.28	33.4
2000	62		FOA1105020010310	FOA1105020010300	855	1336	1646	5.4	1.28	37.0
2300	62		FOA1105023010300		983	1537	1893	6.2	1.28	42.2
2600	62		FOA1105026010310	FOA1105026010300	1111	1737	2140	7.0	1.28	47.5
3000	62		FOA1105030010310		1282	2004	2469	8.1	1.28	54.6
Typ 21										
400	72		FOA2105004011310		230	361	445	2.2	1.29	12.0
500	72		FOA2105005011310	FOA2105005011300	288	451	557	2.8	1.29	14.6
600	72		FOA2105006011310		345	541	668	3.3	1.29	17.5
700	72		FOA2105007011310	FOA2105007011300	403	632	779	3.9	1.29	19.6
800	72		FOA2105008011310		461	722	890	4.4	1.29	22.2
900	72		FOA2105009011310	FOA2105009011300	518	812	1002	5.0	1.29	24.6
1000	72		FOA2105010011310	FOA2105010011300	576	902	1113	5.5	1.29	27.2
1100	72		FOA2105011011310		633	993	1224	6.0	1.29	29.7
1200	72		FOA2105012011310	FOA2105012011300	691	1083	1336	6.6	1.29	32.3
1400	72		FOA2105014011310		806	1263	1558	7.7	1.29	37.3



500

Höhe 500 mm	Länge	Tiefe	Artikelnummer (links)	Artikelnummer (rechts)	Systemtemperatur 55/45/20 °C	Systemtemperatur 70/55/20 °C	Systemtemperatur 75/65/20 °C	Volumen (l)	Exponent n	Gewicht (kg)
	1600	72	FOA2105016011310	FOA2105016011300	921	1444	1781	8.8	1.29	42.4
	1800	72	FOA2105018011310	FOA2105018011300	1036	1624	2003	9.9	1.29	47.5
	2000	72	FOA2105020011310	FOA2105020011300	1151	1805	2226	11.0	1.29	52.5
	2300	72	FOA2105023011310	FOA2105023011300	1324	2076	2560	12.7	1.29	6.1
	2600	72		FOA2105026011310	1497	2346	2894	14.3	1.29	67.8
	3000	72		FOA2105030011300	1727	2707	3339	16.5	1.29	77.9
Typ 22										
	400	104	FOA2205004011310	FOA2205004011300	294	466	578	2.2	1.32	13.7
	500	104		FOA2205005011310	368	583	722	2.8	1.32	16.5
	600	104	FOA2205006011310	FOA2205006011300	442	699	866	3.3	1.32	19.3
	700	104	FOA2205007011310	FOA2205007011300	515	816	1011	3.9	1.32	22.2
	800	104	FOA2205008011310	FOA2205008011300	589	932	1155	4.4	1.32	25.0
	900	104	FOA2205009011310	FOA2205009011300	662	1049	1300	5.0	1.32	27.8
	1000	104	FOA2205010011310	FOA2205010011300	736	1165	1444	5.5	1.32	3.6
	1200	104	FOA2205012011310	FOA2205012011300	883	1398	1733	6.6	1.32	36.2
	1400	104	FOA2205014011310	FOA2205014011300	1030	1631	2022	7.7	1.32	41.9
	1600	104	FOA2205016011310	FOA2205016011300	1177	1864	2310	8.8	1.32	47.5
	1800	104	FOA2205018011310	FOA2205018011300	1325	2097	2599	9.9	1.32	53.2
	2000	104	FOA2205020011310	FOA2205020011300	1472	2331	2888	11.0	1.32	58.8
	2300	104	FOA2205023011310	FOA2205023011300	1692	2680	3321	12.7	1.32	67.2
	2600	104		FOA2205026011300	1913	3030	3754	14.3	1.32	75.7
	3000	104		FOA2205030011310	2208	3496	4332	16.5	1.32	87.0
Typ 33										
	400	154	FOA3305004011310	FOA3305004011300	404	642	798	3.3	1.33	18.8
	500	154		FOA3305005011300	505	803	997	4.1	1.33	22.8
	600	154		FOA3305006011300	606	963	1196	4.9	1.33	27.0



500

Höhe 500 mm	Länge	Tiefe	Artikelnummer (links)	Artikelnummer (rechts)	Systemtemperatur 55/45/20 °C	Systemtemperatur 70/55/20 °C	Systemtemperatur 75/65/20 °C	Volumen (l)	Exponent n	Gewicht (kg)
700	154		FOA3305007011310	FOA3305007011300	706	1124	1396	5.7	1.33	4.0
800	154		FOA3305008011310	FOA3305008011300	807	1284	1595	6.6	1.33	35.2
900	154		FOA3305009011300		908	1445	1795	7.4	1.33	40.0
1000	154		FOA3305010011310	FOA3305010011300	1009	1606	1994	8.2	1.33	43.2
1100	154		FOA3305011011310		1110	1766	2193	9.0	1.33	47.2
1200	154		FOA3305012011310	FOA3305012011300	1211	1927	2393	9.8	1.33	51.3
1400	154		FOA3305014011310	FOA3305014011300	1413	2248	2792	11.5	1.33	59.4
1600	154		FOA3305016011310	FOA3305016011300	1615	2569	3190	13.1	1.33	67.6
1800	154		FOA3305018011310	FOA3305018011300	1817	2890	3589	14.8	1.33	75.7
2000	154		FOA3305020011310		2018	3211	3988	16.4	1.33	83.8
2300	154		FOA3305023011310	FOA3305023011300	2321	3693	4586	18.9	1.33	96.2
2600	154		FOA3305026011310		2624	4175	5184	21.3	1.33	112.5
3000	154		FOA3305030011310	FOA3305030011300	3028	4817	5982	24.6	1.33	124.5



600

Höhe 600 mm	Länge	Tiefe	Artikelnummer (links)	Artikelnummer (rechts)	Systemtemperatur 55/45/20 °C	Systemtemperatur 70/55/20 °C	Systemtemperatur 75/65/20 °C	Volumen (l)	Exponent n	Gewicht (kg)
Typ 11										
400	62		FOA1106004010310	FOA1106004010300	200	312	384	1.3	1.28	1.3
500	62		FOA1106005010310	FOA1106005010300	249	390	481	1.6	1.28	12.4
600	62		FOA1106006010310		299	468	577	1.9	1.28	14.6
700	62		FOA1106007010300		349	546	673	2.2	1.28	16.7
800	62		FOA1106008010310	FOA1106008010300	399	624	769	2.6	1.28	18.9
900	62		FOA1106009010310	FOA1106009010300	449	702	865	2.9	1.28	3.0
1000	62		FOA1106010010310	FOA1106010010300	499	780	961	3.2	1.28	23.1
1100	62		FOA1106011010310	FOA1106011010300	549	858	1057	3.5	1.28	25.2
1200	62		FOA1106012010310		599	936	1153	3.8	1.28	27.4
1400	62		FOA1106014010310	FOA1106014010300	699	1092	1345	4.5	1.28	31.6
1600	62		FOA1106016010310		798	1248	1538	5.1	1.28	35.9
1800	62		FOA1106018010310		898	1404	1730	5.8	1.28	4.2
2000	62		FOA1106020010300		998	1560	1922	6.4	1.28	44.4
2300	62		FOA1106023010310	FOA1106023010300	1148	1794	2210	7.4	1.28	5.8
2600	62		FOA1106026010300		1297	2028	2499	8.3	1.28	57.2
Typ 21										
400	72		FOA2106004011310	FOA2106004011300	266	417	515	2.6	1.30	14.4
500	72		FOA2106005011310		332	522	644	3.3	1.30	17.5
600	72		FOA2106006011300		398	626	773	4.0	1.30	2.5
700	72		FOA2106007011300		465	730	902	4.6	1.30	23.6
800	72		FOA2106008011300		531	835	1030	5.3	1.30	26.6
900	72		FOA2106009011310	FOA2106009011300	598	939	1159	5.9	1.30	29.7
1000	72		FOA2106010011310	FOA2106010011300	664	1043	1288	6.6	1.30	32.7
1100	72		FOA2106011011310	FOA2106011011300	731	1148	1417	7.3	1.30	35.8
1200	72		FOA2106012011300		797	1252	1546	7.9	1.30	38.8



600

Höhe 600 mm	Länge	Tiefe	Artikelnummer (links)	Artikelnummer (rechts)	Systemtemperatur 55/45/20 °C	Systemtemperatur 70/55/20 °C	Systemtemperatur 75/65/20 °C	Volumen (l)	Exponent n	Gewicht (kg)
1400	72		FOA2106014011310	FOA2106014011300	930	1461	1803	9.2	1.30	44.9
1600	72		FOA2106016011310	FOA2106016011300	1063	1669	2061	10.6	1.30	51.1
1800	72		FOA2106018011310	FOA2106018011300	1195	1878	2318	11.9	1.30	57.1
2000	72		FOA2106020011310	FOA2106020011300	1328	2087	2576	13.2	1.30	63.2
2300	72		FOA2106023011310	FOA2106023011300	1527	2400	2962	15.2	1.30	72.4
2600	72		FOA2106026011300		1727	2712	3349	17.2	1.30	81.5
3000	72		FOA2106030011300		1992	3130	3864	19.8	1.30	93.7

Typ 22

400	104		FOA2206004011310	FOA2206004011300	340	540	670	2.6	1.33	16.4
500	104		FOA2206005011310	FOA2206005011300	425	675	838	3.3	1.33	19.8
600	104		FOA2206006011300		510	810	1006	4.0	1.33	23.3
700	104		FOA2206007011310	FOA2206007011300	595	945	1173	4.6	1.33	26.7
800	104		FOA2206008011310	FOA2206008011300	680	1080	1341	5.3	1.33	3.2
900	104		FOA2206009011310	FOA2206009011300	765	1215	1508	5.9	1.33	33.7
1100	104		FOA2206011011310	FOA2206011011300	935	1485	1844	7.3	1.33	4.6
1200	104		FOA2206012011310	FOA2206012011300	1020	1620	2011	7.9	1.33	44.2
1400	104		FOA2206014011310	FOA2206014011300	1190	1890	2346	9.2	1.33	5.9
1600	104		FOA2206016011310	FOA2206016011300	1360	2161	2682	10.6	1.33	57.8
1800	104		FOA2206018011310	FOA2206018011300	1530	2431	3017	11.9	1.33	64.7
2000	104		FOA2206020011310	FOA2206020011300	1700	2701	3352	13.2	1.33	71.7
2300	104		FOA2206023011310	FOA2206023011300	1955	3106	3855	15.2	1.33	82.3
2600	104		FOA2206026011310	FOA2206026011300	2210	3511	4358	17.2	1.33	92.4
3000	104		FOA2206030011310	FOA2206030011300	2549	4051	5028	19.8	1.33	110.4

Typ 33

400	154		FOA3306004011310	FOA3306004011300	465	743	924	3.9	1.34	22.5
500	154		FOA3306005011310	FOA3306005011300	582	928	1155	4.9	1.34	27.4



600

Höhe 600 mm	Länge	Tiefe	Artikelnummer (links)	Artikelnummer (rechts)	Systemtemperatur 55/45/20 °C	Systemtemperatur 70/55/20 °C	Systemtemperatur 75/65/20 °C	Volumen (l)	Exponent n	Gewicht (kg)
600	154		FOA3306006011310	FOA3306006011300	698	1114	1385	5.9	1.34	32.2
700	154		FOA3306007011300		814	1300	1616	6.9	1.34	37.9
800	154		FOA3306008011310	FOA3306008011300	931	1485	1847	7.8	1.34	42.0
900	154		FOA3306009011310	FOA3306009011300	1047	1671	2078	8.8	1.34	46.8
1000	154		FOA3306010011300		1164	1857	2309	9.8	1.34	51.7
1100	154		FOA3306011011310	FOA3306011011300	1280	2042	2540	10.8	1.34	56.6
1200	154		FOA3306012011310	FOA3306012011300	1396	2228	2771	11.8	1.34	61.4
1400	154		FOA3306014011310		1629	2599	3233	13.7	1.34	71.2
1600	154		FOA3306016011310	FOA3306016011300	1862	2971	3694	15.7	1.34	8.9
1800	154		FOA3306018011310	FOA3306018011300	2094	3342	4156	17.6	1.34	9.7
2000	154		FOA3306020011310		2327	3713	4618	19.6	1.34	14
2300	154		FOA3306023011300		2676	4270	5311	22.5	1.34	115.1
2600	154		FOA3306026011310	FOA3306026011300	3025	4827	6003	25.5	1.34	129.6
3000	154		FOA3306030011310	FOA3306030011300	3491	5570	6927	29.4	1.34	149.9



900

Höhe 900 mm	Länge	Tiefe	Artikelnummer (links)	Artikelnummer (rechts)	Systemtemperatur 55/45/20 °C	Systemtemperatur 70/55/20 °C	Systemtemperatur 75/65/20 °C	Volumen (l)	Exponent n	Gewicht (kg)
Typ 11										
400	62		FOA1109004010310		277	436	539	1.8	1.30	14.9
500	62		FOA1109005010310	FOA1109005010300	346	545	674	2.3	1.30	18.2
600	62		FOA1109006010300		416	654	808	2.7	1.30	21.4
900	62		FOA1109009010310	FOA1109009010300	624	981	1212	4.0	1.30	31.1
1000	62		FOA1109010010310	FOA1109010010300	693	1090	1347	4.5	1.30	34.3
1100	62		FOA1109011010310	FOA1109011010300	762	1199	1482	5.0	1.30	37.6
1200	62		FOA1109012010310	FOA1109012010300	831	1308	1616	5.4	1.30	4.8
1400	62		FOA1109014010300		970	1526	1886	6.3	1.30	47.3
1600	62		FOA1109016010310	FOA1109016010300	1109	1744	2155	7.2	1.30	53.8
1800	62		FOA1109018010310	FOA1109018010300	1247	1962	2425	8.1	1.30	6.2
2000	62		FOA1109020010310		1386	2180	2694	9.0	1.30	66.7
Typ 21										
400	72		FOA2109004011310	FOA2109004011300	357	568	706	3.6	1.34	2.9
500	72		FOA2109005011310	FOA2109005011300	446	710	883	4.5	1.34	25.5
600	72		FOA2109006011310		535	852	1059	5.4	1.34	3.2
700	72		FOA2109007011310	FOA2109007011300	624	994	1236	6.3	1.34	34.8
800	72		FOA2109008011310		713	1136	1412	7.2	1.34	39.4
900	72		FOA2109009011310		802	1278	1589	8.1	1.34	44.1
1000	72		FOA2109010011310	FOA2109010011300	891	1420	1765	9.0	1.34	48.7
1100	72		FOA2109011011310	FOA2109011011300	981	1562	1942	9.9	1.34	53.4
1200	72		FOA2109012011310	FOA2109012011300	1070	1704	2118	10.8	1.34	58.4
1400	72		FOA2109014011310	FOA2109014011300	1248	1988	2471	12.6	1.34	67.3
1600	72		FOA2109016011310	FOA2109016011300	1426	2272	2824	14.4	1.34	76.6
1800	72		FOA2109018011300		1605	2556	3177	16.2	1.34	85.9
2000	72		FOA2109020011310	FOA2109020011300	1783	2841	3530	18.0	1.34	95.2



900

Höhe 900 mm	Länge	Tiefe	Artikelnummer (links)	Artikelnummer (rechts)	Systemtemperatur 55/45/20 °C	Systemtemperatur 70/55/20 °C	Systemtemperatur 75/65/20 °C	Volumen (l)	Exponent n	Gewicht (kg)
Typ 22										
400	104		FOA2209004011310	FOA2209004011300	462	739	920	3.6	1.35	23.9
500	104		FOA2209005011300		578	924	1151	4.5	1.35	28.9
600	104		FOA2209006011310		693	1109	1381	5.4	1.35	34.9
700	104		FOA2209007011310		809	1294	1611	6.3	1.35	39.2
800	104	FOA2209008011310	FOA2209008011300		924	1478	1841	7.2	1.35	44.4
900	104	FOA2209009011310	FOA2209009011300		1040	1663	2071	8.1	1.35	49.5
1000	104	FOA2209010011300			1155	1848	2301	9.0	1.35	54.6
1100	104	FOA2209011011310	FOA2209011011300		1271	2033	2531	9.9	1.35	59.8
1200	104	FOA2209012011310			1386	2218	2761	10.8	1.35	64.9
1400	104	FOA2209014011310			1617	2587	3221	12.6	1.35	75.2
1600	104	FOA2209016011310	FOA2209016011300		1848	2957	3682	14.4	1.35	85.5
1800	104	FOA2209018011310	FOA2209018011300		2080	3327	4142	16.2	1.35	95.7
2000	104	FOA2209020011310	FOA2209020011300		2311	3696	4602	18.0	1.35	110.2
Typ 33										
400	154	FOA3309004011310	FOA3309004011300		633	1017	1268	5.3	1.36	33.8
500	154	FOA3309005011300			791	1271	1586	6.7	1.36	4.4
600	154	FOA3309006011310	FOA3309006011300		949	1525	1903	8.0	1.36	47.8
700	154	FOA3309007011310	FOA3309007011300		1107	1779	2220	9.3	1.36	55.2
800	154	FOA3309008011300			1266	2033	2537	10.6	1.36	62.6
900	154	FOA3309009011310	FOA3309009011300		1424	2288	2854	12.0	1.36	69.9
1000	154	FOA3309010011300			1582	2542	3171	13.3	1.36	77.3
1100	154	FOA3309011011300			1740	2796	3488	14.6	1.36	84.7
1200	154	FOA3309012011310	FOA3309012011300		1898	3050	3805	16.0	1.36	92.6
1400	154	FOA3309014011310	FOA3309014011300		2215	3558	4439	18.6	1.36	111.1
1600	154	FOA3309016011310			2531	4067	5074	21.3	1.36	121.5

