



## Fiche technique

2026-05-20

# T6 3010 Deco

Radiateur panneau habillé, 6 orifices, face avant rainurée.



- ✓ Convient à tous les styles d'intérieur
- ✓ Technologie brevetée d'alimentation en forme de T intégré au radiateur
- ✓ Installation simplifiée grâce au raccordement central
- ✓ Flexibilité dans le choix de la tête thermostatique
- ✓ Installation rapide

Le radiateur panneau habillé T6 3010 Déco est équipé d'une face avant plane lisse aux bords arrondis, de joues latérales et d'une grille supérieure maintenue par des clips marqués FINIMETAL. Raccordement central, 6 orifices, avec une canne intégrée en forme de T. Equipé d'un insert thermostatique universel pré-monté en usine. Pression de service 10 bar. Température de service maximale de 110°C. Inclus : consoles de fixation, étriers, bouchons Couleur standard blanc (RAL 9016). Décliné en 63 couleurs, avec supplément tarifaire.



### Domaine d'application

Le radiateur T6 3010 Deco convient aux espaces résidentiels et commerciaux. Il offre une Raccordement centrale, un tuyau en forme de T intégré, une pression de fonctionnement de 10 bars et un insert thermostatique M30x1.5 pré-monté. Idéal pour les salons, bureaux et boutiques.

### Critères de sélection

Pour la sélection de produits, consultez notre service de conception ou utilisez notre brochure pour une sélection rapide.

### Usage

Lors de l'installation du T6 3010 Deco, assurez-vous d'utiliser la Raccordement centrale. Le tuyau en T intégré simplifie l'installation. L'insert thermostatique M30x1.5 monté en usine ne nécessite aucun réglage supplémentaire. Envisagez de remplacer les capuchons de protection centraux par des capuchons complets

lors de l'utilisation d'une Raccordement traditionnelle. Assurez-vous que le radiateur est solidement fixé à l'aide des supports fournis, et terminez l'installation en fixant les panneaux latéraux et la grille décorative avant à l'aide des clips.

### AMA Text

Le radiateur T6 3010 Deco présente un panneau avant décoratif rainuré et des panneaux latéraux fixés par des clips subtils, le transformant en un élément élégant de tout intérieur. Il est doté d'une Raccordement centrale, d'un tuyau en T intégré, d'une pression de service de 10 bars et d'un insert thermostatique M30x1.5 pré-monté en usine pour une installation polyvalente et facile. Idéal pour les applications résidentielles et commerciales, il offre à la fois un attrait esthétique et un chauffage efficace. Disponible en différentes tailles, de 300 mm à 900 mm de hauteur et de 400 mm à 3000 mm de longueur, il couvre une large gamme de puissances pour répondre à divers besoins de chauffage. Couleur: RAL 9016



# Spécifications

CARACTÉRISTIQUES	UNITÉ	VALEURS
ETIM Class		EC011022
Matériel		--
Type		11, 21, 22, 33
Structure de surface		--
Pression de service max.	bar	10
Nombre de raccords standard		--
Capacité thermique selon EN 442		Oui
Température de fonctionnement maximale	°C	--
Couleur standard		Oui
Couleur		--
Numéro RAL		--
Grille latérale		Oui
Grille supérieure		Oui
Degré de brillance		--
Dimension du filetage (en pouces)		--
Raccord fileté		--
Avec raccordement 1 point		Oui
Avec raccord de purge d'air		Oui
Avec purgeur d'air		Oui
Avec orifice de vidange		Oui



# Documents

DOCUMENTS	TYPE DE DOCUMENT	LIEN
Manuel d'installation fixations murales MCW-6 (sauf pour type 21KV 22KV)	User	<a href="https://asset.productmarketingcloud.com/api/assetstorage/3577_030df0cf-cefc-4820-b050-184afe84b470">https://asset.productmarketingcloud.com/api/assetstorage/3577_030df0cf-cefc-4820-b050-184afe84b470</a>
Manuel d'installation raccordement T6 3010	User	<a href="https://asset.productmarketingcloud.com/api/assetstorage/3577_f1100226-4651-43c5-a9d3-5f8566b65eb1">https://asset.productmarketingcloud.com/api/assetstorage/3577_f1100226-4651-43c5-a9d3-5f8566b65eb1</a>



# Sources



ProductImage - T6 3010 Deco

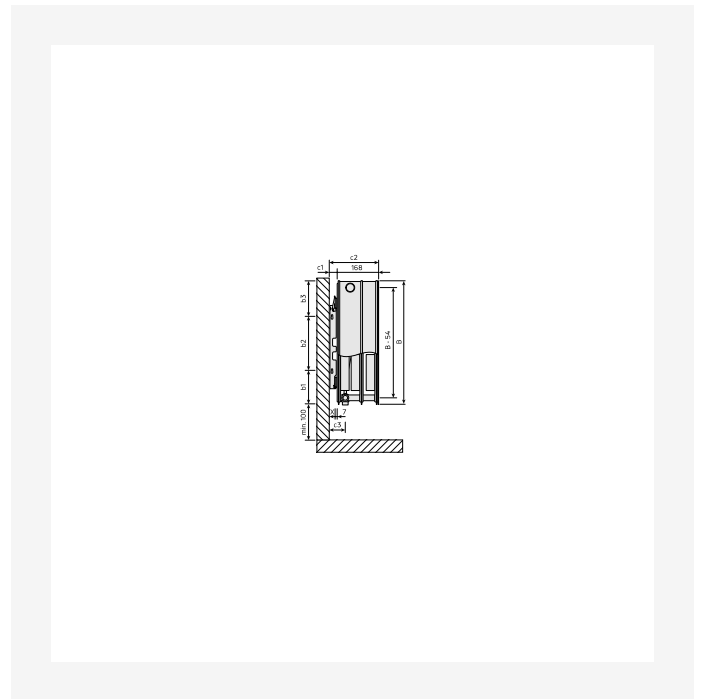

DimensionalDrawing - T6 3010 Plan/Deco type 33 H400\_900, Vue latérale

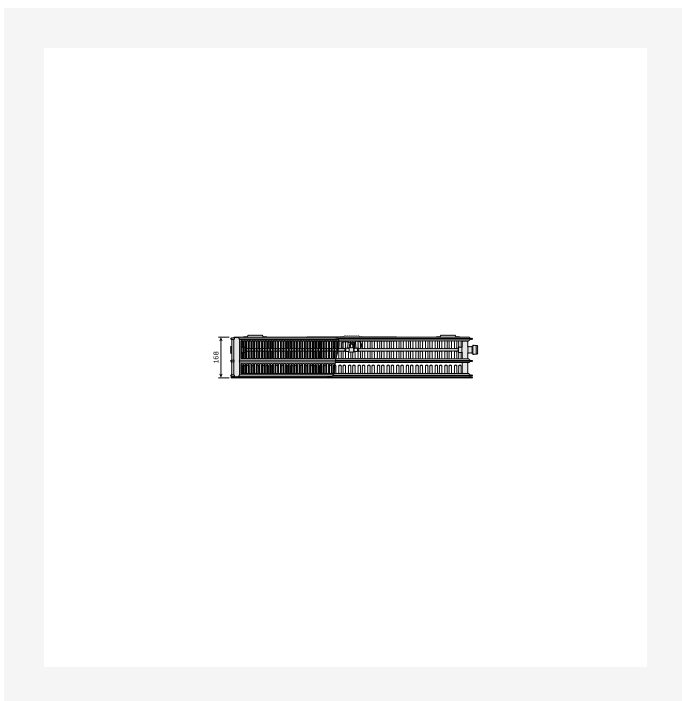

DimensionalDrawing - T6 3010 Plan/Déco, type 33, Vue du dessus

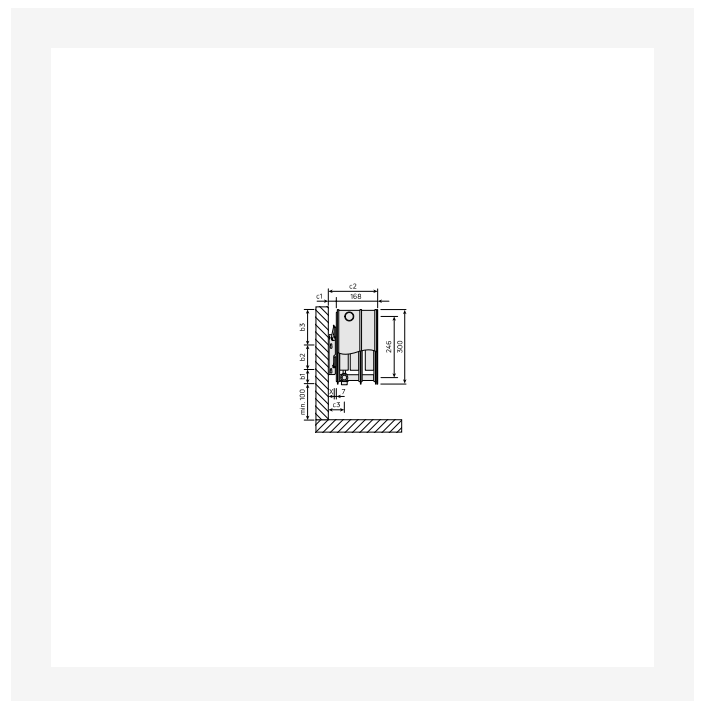

DimensionalDrawing - T6 3010 Plan/Deco type 33 H300, Vue latérale



# Sources



DimensionalDrawing - T6 3010 Plan/Déco, type 22, Vue du dessus

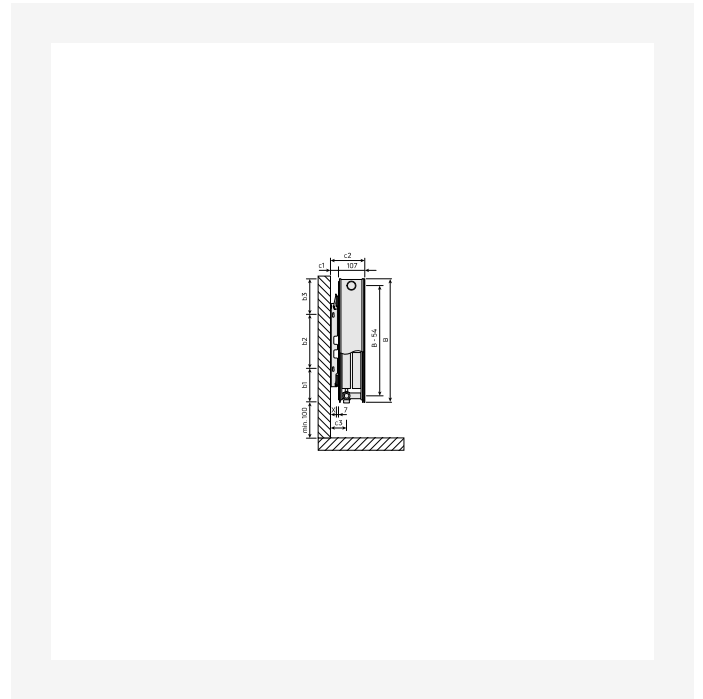

DimensionalDrawing - T6 3010 Plan/Déco type 22 H400\_900, Vue latérale

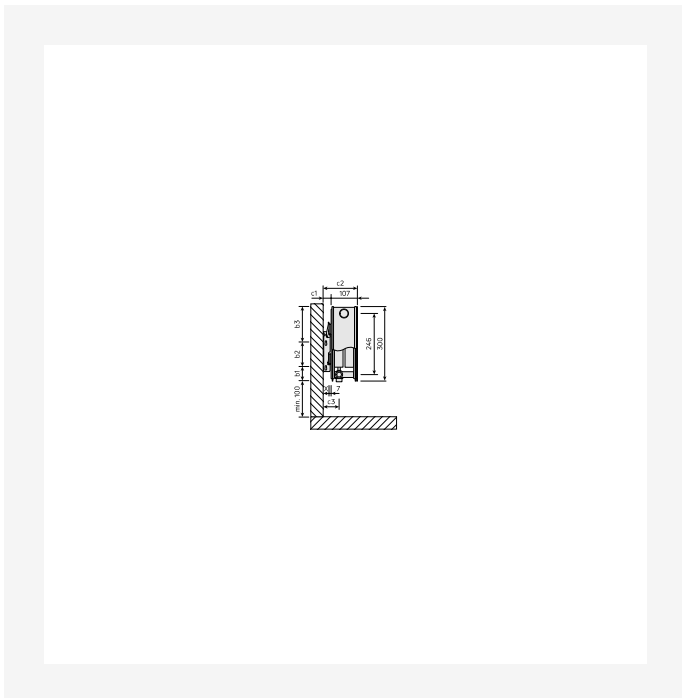

DimensionalDrawing - T6 3010 Plan/Déco type 22 H300, Vue latérale



DimensionalDrawing - T6 3010 Plan/Déco, type 21, Vue du dessus



# Sources

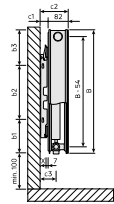

DimensionalDrawing - T6 3010 Plan/Deco type 21 H400\_900, Vue latérale

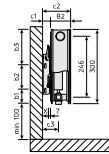

DimensionalDrawing - T6 3010 Plan/Deco type 21 H300, Vue latérale







# Accessoires

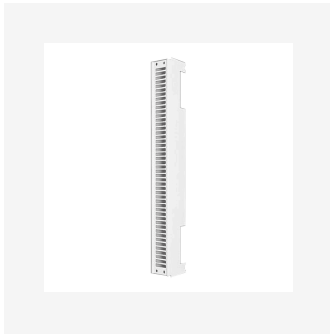

Grille supérieure Vonova



Purgeur T6



Clé de purge

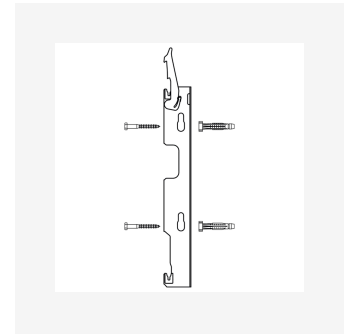

Console radiateur panneau  
Reggane 3010 et T6  
(Compact/Plan/Déco)

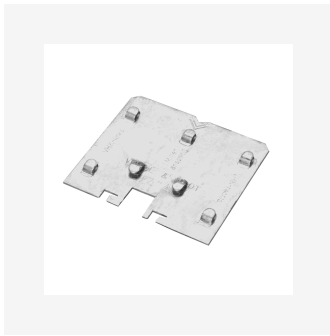

Plaque adaptable T6



Aérosol peinture réparation



Equerre de montage pour  
cloisons creuses



Tête thermostatique  
TRVFIN3



By-Pass



Bouchon plein



Copper Connect KMF



Bouchon 1/2"



# Accessoires



Tête Thermostatique Sensity  
M30



## 300

HAUTEUR 300 mm	LONGEUR	PROFONDEUR	CODE ARTICLE	Puissance (W) 75/65/20°C	Puissance (W) 55/45/20°C	VOLUME (l)	EXPOSANT N	POIDS (kg)
<b>Type 11</b>								
400	63		11DM300 0400	213	109	0.0	1.31	6.0
520	63		11DM300 0520	277	142	0.0	1.31	7.3
600	63		11DM300 0600	319	163	0.0	1.31	9.0
720	63		11DM300 0720	383	196	0.0	1.31	10.4
800	63		11DM300 0800	426	218	0.0	1.31	15
920	63		11DM300 0920	489	251	0.0	1.31	11.9
1000	63		11DM300 1000	532	272	0.0	1.31	12.8
1120	63		11DM300 1120	596	305	0.0	1.31	14.2
1200	63		11DM300 1200	638	327	0.0	1.31	15.8
<b>Type 21</b>								
400	80		21DM300 0400	313	159	0.0	1.33	8.2
520	80		21DM300 0520	407	207	0.0	1.33	11
600	80		21DM300 0600	470	238	0.0	1.33	11.4
720	80		21DM300 0720	564	286	0.0	1.33	13.4
800	80		21DM300 0800	626	318	0.0	1.33	14.7
920	80		21DM300 0920	720	366	0.0	1.33	16.7
1000	80		21DM300 1000	783	397	0.0	1.33	18.4
1120	80		21DM300 1120	877	445	0.0	1.33	20.0
1200	80		21DM300 1200	940	477	0.0	1.33	21.3
1320	80		21DM300 1320	1034	525	0.0	1.33	23.3
1400	80		21DM300 1400	1096	556	0.0	1.33	24.6
1600	80		21DM300 1600	1253	636	0.0	1.33	27.9



## 300

HAUTEUR 300 mm	LONGEUR	PROFONDEUR	CODE ARTICLE	Puissance (W) 75/65/20°C	Puissance (W) 55/45/20°C	VOLUME (l)	EXPOSANT N	POIDS (kg)
	1800	80	21DM300 1800	1409	715	0.0	1.33	31.3
<b>Type 22</b>								
	800	105	22DM300 0800	857	439	0.0	1.31	17.1
	920	105	22DM300 0920	985	505	0.0	1.31	19.5
	1000	105	22DM300 1000	1071	549	0.0	1.31	21.5
	1120	105	22DM300 1120	1200	615	0.0	1.31	23.4
	1200	105	22DM300 1200	1285	659	0.0	1.31	24.9
	1320	105	22DM300 1320	1414	725	0.0	1.31	27.2
	1400	105	22DM300 1400	1499	769	0.0	1.31	28.9
	1600	105	22DM300 1600	1714	878	0.0	1.31	32.7
	1800	105	22DM300 1800	1928	988	0.0	1.31	36.8
	2000	105	22DM300 2000	2142	1098	0.0	1.31	4.6
	2200	105	22DM300 2200	2356	1208	0.0	1.31	44.5
	2400	105	22DM300 2400	2570	1318	0.0	1.31	48.3
	2600	105	22DM300 2600	2785	1427	0.0	1.31	52.2
	2800	105	22DM300 2800	2999	1537	0.0	1.31	56.7
	3000	105	22DM300 3000	3213	1647	0.0	1.31	59.9
<b>Type 33</b>								
	800	166	33DM300 0800	1253	640	0.0	1.31	24.2



# 300

HAUTEUR 300 mm	LONGEUR	PROFONDEUR	CODE ARTICLE	Puissance (W) 75/65/20°C	Puissance (W) 55/45/20°C	VOLUME (l)	EXPOSANT N	POIDS (kg)
	920	166	33DM300 0920	1441	736	0.0	1.31	27.7
	1000	166	33DM300 1000	1566	801	0.0	1.31	29.9
	1120	166	33DM300 1120	1754	897	0.0	1.31	33.2
	1200	166	33DM300 1200	1879	961	0.0	1.31	35.4
	1320	166	33DM300 1320	2067	1057	0.0	1.31	38.8
	1400	166	33DM300 1400	2192	1121	0.0	1.31	41.1
	1600	166	33DM300 1600	2506	1281	0.0	1.31	46.6
	1800	166	33DM300 1800	2819	1441	0.0	1.31	52.4
	2000	166	33DM300 2000	3132	1601	0.0	1.31	57.9
	2200	166	33DM300 2200	3445	1761	0.0	1.31	63.5



## 400

HAUTEUR 400 mm	LONGEUR	PROFONDEUR	CODE ARTICLE	Puissance (W) 75/65/20°C	Puissance (W) 55/45/20°C	VOLUME (l)	EXPOSANT N	POIDS (kg)
<b>Type 11</b>								
400	63		11DM400 0400	264	134	0.0	1.32	7.6
520	63		11DM400 0520	343	175	0.0	1.32	10.3
600	63		11DM400 0600	396	202	0.0	1.32	1.7
720	63		11DM400 0720	475	242	0.0	1.32	12.5
800	63		11DM400 0800	528	269	0.0	1.32	13.8
920	63		11DM400 0920	607	309	0.0	1.32	15.6
1000	63		11DM400 1000	660	336	0.0	1.32	16.8
1120	63		11DM400 1120	739	376	0.0	1.32	18.7
1200	63		11DM400 1200	792	403	0.0	1.32	19.9
1320	63		11DM400 1320	871	444	0.0	1.32	21.9
1400	63		11DM400 1400	924	471	0.0	1.32	23.9
1600	63		11DM400 1600	1056	538	0.0	1.32	26.2
1800	63		11DM400 1800	1188	605	0.0	1.32	31.0
<b>Type 21</b>								
400	80		21DM400 0400	395	201	0.0	1.33	14
520	80		21DM400 0520	514	261	0.0	1.33	13.1
600	80		21DM400 0600	593	301	0.0	1.33	14.9
720	80		21DM400 0720	711	361	0.0	1.33	17.5
800	80		21DM400 0800	790	401	0.0	1.33	19.3
920	80		21DM400 0920	909	462	0.0	1.33	22.0
1000	80		21DM400 1000	988	502	0.0	1.33	23.7
1120	80		21DM400 1120	1107	562	0.0	1.33	26.4
1200	80		21DM400 1200	1186	602	0.0	1.33	28.1



## 400

HAUTEUR 400 mm	LONGEUR	PROFONDEUR	CODE ARTICLE	Puissance (W) 75/65/20°C	Puissance (W) 55/45/20°C	VOLUME (l)	EXPOSANT N	POIDS (kg)
	1320	80	21DM400 1320	1304	662	0.0	1.33	3.8
	1400	80	21DM400 1400	1383	702	0.0	1.33	32.6
	1600	80	21DM400 1600	1581	803	0.0	1.33	37.0
	1800	80	21DM400 1800	1778	903	0.0	1.33	41.6
<b>Type 22</b>								
	400	105	22DM400 0400	534	271	0.0	1.33	12.2
	520	105	22DM400 0520	695	353	0.0	1.33	15.3
	600	105	22DM400 0600	802	407	0.0	1.33	17.5
	720	105	22DM400 0720	962	488	0.0	1.33	2.7
	800	105	22DM400 0800	1069	542	0.0	1.33	22.8
	920	105	22DM400 0920	1229	624	0.0	1.33	26.6
	1000	105	22DM400 1000	1336	678	0.0	1.33	28.2
	1120	105	22DM400 1120	1496	759	0.0	1.33	31.4
	1200	105	22DM400 1200	1603	813	0.0	1.33	33.5
	1320	105	22DM400 1320	1764	895	0.0	1.33	36.7
	1400	105	22DM400 1400	1870	949	0.0	1.33	38.9
	1600	105	22DM400 1600	2138	1085	0.0	1.33	44.2
	1800	105	22DM400 1800	2405	1220	0.0	1.33	49.7
	2000	105	22DM400 2000	2672	1356	0.0	1.33	55.0
	2200	105	22DM400 2200	2939	1491	0.0	1.33	6.3



## 400

HAUTEUR 400 mm	LONGEUR	PROFONDEUR	CODE ARTICLE	Puissance (W) 75/65/20°C	Puissance (W) 55/45/20°C	VOLUME (l)	EXPOSANT N	POIDS (kg)
	2400	105	22DM400 2400	3206	1627	0.0	1.33	65.6
	2600	105	22DM400 2600	3474	1763	0.0	1.33	7.9
	2800	105	22DM400 2800	3741	1898	0.0	1.33	76.2
	3000	105	22DM400 3000	4008	2034	0.0	1.33	81.5
<b>Type 33</b>								
	800	166	33DM400 0800	1557	784	0.0	1.34	32.4
	920	166	33DM400 0920	1790	902	0.0	1.34	37.8
	1000	166	33DM400 1000	1946	980	0.0	1.34	4.1
	1120	166	33DM400 1120	2180	1098	0.0	1.34	44.7
	1200	166	33DM400 1200	2335	1176	0.0	1.34	47.8
	1320	166	33DM400 1320	2569	1294	0.0	1.34	52.3
	1400	166	33DM400 1400	2724	1372	0.0	1.34	55.5
	1600	166	33DM400 1600	3114	1569	0.0	1.34	63.1
	1800	166	33DM400 1800	3503	1765	0.0	1.34	8.0
	2000	166	33DM400 2000	3892	1961	0.0	1.34	78.6



## 500

HAUTEUR 500 mm	LONGEUR	PROFONDEUR	CODE ARTICLE	Puissance (W) 75/65/20°C	Puissance (W) 55/45/20°C	VOLUME (l)	EXPOSANT N	POIDS (kg)
<b>Type 11</b>								
	400	63	11DM500 0400	314	160	0.0	1.31	8.7
	520	63	11DM500 0520	408	208	0.0	1.31	1.8
	600	63	11DM500 0600	470	241	0.0	1.31	12.3
	720	63	11DM500 0720	564	289	0.0	1.31	14.4
	800	63	11DM500 0800	627	321	0.0	1.31	15.9
	920	63	11DM500 0920	721	369	0.0	1.31	18.1
	1000	63	11DM500 1000	784	401	0.0	1.31	19.4
	1120	63	11DM500 1120	878	449	0.0	1.31	21.6
	1200	63	11DM500 1200	941	481	0.0	1.31	23.3
	1320	63	11DM500 1320	1035	529	0.0	1.31	25.3
	1400	63	11DM500 1400	1098	561	0.0	1.31	26.7
	1600	63	11DM500 1600	1254	641	0.0	1.31	3.3
	1800	63	11DM500 1800	1411	722	0.0	1.31	33.9
	2000	63	11DM500 2000	1568	802	0.0	1.31	37.5
<b>Type 21</b>								
	400	80	21DM500 0400	469	242	0.0	1.30	12.2
	520	80	21DM500 0520	610	314	0.0	1.30	15.4
	600	80	21DM500 0600	704	362	0.0	1.30	17.5
	720	80	21DM500 0720	845	435	0.0	1.30	2.6
	800	80	21DM500 0800	938	483	0.0	1.30	22.7
	920	80	21DM500 0920	1079	556	0.0	1.30	25.9
	1000	80	21DM500 1000	1173	604	0.0	1.30	28.0
	1120	80	21DM500 1120	1314	676	0.0	1.30	31.1



## 500

HAUTEUR 500 mm	LONGEUR	PROFONDEUR	CODE ARTICLE	Puissance (W) 75/65/20°C	Puissance (W) 55/45/20°C	VOLUME (l)	EXPOSANT N	POIDS (kg)
	1200	80	21DM500 1200	1408	725	0.0	1.30	33.2
	1320	80	21DM500 1320	1548	797	0.0	1.30	36.4
	1400	80	21DM500 1400	1642	846	0.0	1.30	38.5
	1600	80	21DM500 1600	1877	966	0.0	1.30	43.8
	1800	80	21DM500 1800	2111	1087	0.0	1.30	49.1
	2000	80	21DM500 2000	2346	1208	0.0	1.30	54.4
<b>Type 22</b>								
	400	105	22DM500 0400	608	309	0.0	1.32	14.0
	520	105	22DM500 0520	790	402	0.0	1.32	17.6
	600	105	22DM500 0600	912	464	0.0	1.32	2.1
	720	105	22DM500 0720	1094	557	0.0	1.32	23.8
	800	105	22DM500 0800	1216	619	0.0	1.32	26.3
	920	105	22DM500 0920	1398	712	0.0	1.32	3.2
	1000	105	22DM500 1000	1520	774	0.0	1.32	32.5
	1120	105	22DM500 1120	1702	867	0.0	1.32	36.2
	1200	105	22DM500 1200	1824	928	0.0	1.32	38.6
	1320	105	22DM500 1320	2006	1021	0.0	1.32	42.3
	1400	105	22DM500 1400	2128	1083	0.0	1.32	44.9
	1600	105	22DM500 1600	2432	1238	0.0	1.32	51.0
	1800	105	22DM500 1800	2736	1393	0.0	1.32	57.3



## 500

HAUTEUR 500 mm	LONGEUR	PROFONDEUR	CODE ARTICLE	Puissance (W) 75/65/20°C	Puissance (W) 55/45/20°C	VOLUME (l)	EXPOSANT N	POIDS (kg)
	2000	105	22DM500 2000	3040	1547	0.0	1.32	63.5
	2200	105	22DM500 2200	3344	1702	0.0	1.32	69.6
	2400	105	22DM500 2400	3648	1857	0.0	1.32	75.7
	2600	105	22DM500 2600	3952	2012	0.0	1.32	81.9
	2800	105	22DM500 2800	4256	2166	0.0	1.32	88.2
	3000	105	22DM500 3000	4560	2321	0.0	1.32	94.2
<b>Type 33</b>								
	400	166	33DM500 0400	857	435	0.0	1.33	19.6
	520	166	33DM500 0520	1114	565	0.0	1.33	24.9
	600	166	33DM500 0600	1285	652	0.0	1.33	28.4
	720	166	33DM500 0720	1542	783	0.0	1.33	33.7
	800	166	33DM500 0800	1714	870	0.0	1.33	37.2
	920	166	33DM500 0920	1971	1000	0.0	1.33	42.6
	1000	166	33DM500 1000	2142	1087	0.0	1.33	46.1
	1120	166	33DM500 1120	2399	1218	0.0	1.33	51.4
	1200	166	33DM500 1200	2570	1305	0.0	1.33	54.9
	1320	166	33DM500 1320	2827	1435	0.0	1.33	6.2
	1400	166	33DM500 1400	2999	1522	0.0	1.33	63.8



# 500

HAUTEUR 500 mm	LONGEUR	PROFONDEUR	CODE ARTICLE	Puissance (W) 75/65/20°C	Puissance (W) 55/45/20°C	VOLUME (l)	EXPOSANT N	POIDS (kg)
	1600	166	33DM500 1600	3427	1740	0.0	1.33	72.6
	1800	166	33DM500 1800	3856	1957	0.0	1.33	81.6
	2000	166	33DM500 2000	4284	2175	0.0	1.33	9.4



## 600

HAUTEUR 600 mm	LONGEUR	PROFONDEUR	CODE ARTICLE	Puissance (W) 75/65/20°C	Puissance (W) 55/45/20°C	VOLUME (l)	EXPOSANT N	POIDS (kg)
<b>Type 11</b>								
	400	63	11DM600 0400	338	174	0.0	1.30	10.6
	520	63	11DM600 0520	439	226	0.0	1.30	12.2
	600	63	11DM600 0600	506	260	0.0	1.30	13.8
	720	63	11DM600 0720	608	312	0.0	1.30	16.3
	800	63	11DM600 0800	675	347	0.0	1.30	17.9
	920	63	11DM600 0920	776	399	0.0	1.30	2.3
	1000	63	11DM600 1000	844	434	0.0	1.30	22.0
	1120	63	11DM600 1120	945	486	0.0	1.30	24.4
	1200	63	11DM600 1200	1013	521	0.0	1.30	26.4
	1320	63	11DM600 1320	1114	573	0.0	1.30	28.6
	1400	63	11DM600 1400	1182	607	0.0	1.30	3.2
	1600	63	11DM600 1600	1350	694	0.0	1.30	34.3
	1800	63	11DM600 1800	1519	781	0.0	1.30	38.3
	2000	63	11DM600 2000	1688	868	0.0	1.30	42.4
<b>Type 21</b>								
	400	80	21DM600 0400	520	268	0.0	1.30	13.9
	520	80	21DM600 0520	677	348	0.0	1.30	17.6
	600	80	21DM600 0600	781	401	0.0	1.30	20.0
	720	80	21DM600 0720	937	482	0.0	1.30	23.6
	800	80	21DM600 0800	1041	535	0.0	1.30	26.1
	920	80	21DM600 0920	1197	615	0.0	1.30	29.7
	1000	80	21DM600 1000	1301	669	0.0	1.30	32.1
	1120	80	21DM600 1120	1457	749	0.0	1.30	35.7



## 600

HAUTEUR 600 mm	LONGEUR	PROFONDEUR	CODE ARTICLE	Puissance (W) 75/65/20°C	Puissance (W) 55/45/20°C	VOLUME (l)	EXPOSANT N	POIDS (kg)
	1200	80	21DM600 1200	1561	803	0.0	1.30	38.1
	1320	80	21DM600 1320	1717	883	0.0	1.30	41.8
	1400	80	21DM600 1400	1821	937	0.0	1.30	44.2
	1600	80	21DM600 1600	2082	1070	0.0	1.30	5.3
	1800	80	21DM600 1800	2342	1204	0.0	1.30	56.5
	2000	80	21DM600 2000	2602	1338	0.0	1.30	62.5
<b>Type 22</b>								
	400	105	22DM600 0400	668	337	0.0	1.34	15.7
	520	105	22DM600 0520	868	438	0.0	1.34	19.9
	600	105	22DM600 0600	1001	506	0.0	1.34	22.7
	720	105	22DM600 0720	1202	607	0.0	1.34	26.8
	800	105	22DM600 0800	1335	674	0.0	1.34	29.6
	920	105	22DM600 0920	1535	776	0.0	1.34	33.9
	1000	105	22DM600 1000	1669	843	0.0	1.34	36.6
	1120	105	22DM600 1120	1869	944	0.0	1.34	4.8
	1200	105	22DM600 1200	2003	1012	0.0	1.34	43.6
	1320	105	22DM600 1320	2203	1113	0.0	1.34	47.8
	1400	105	22DM600 1400	2337	1180	0.0	1.34	5.6
	1600	105	22DM600 1600	2670	1349	0.0	1.34	57.6
	1800	105	22DM600 1800	3004	1517	0.0	1.34	64.7



## 600

HAUTEUR 600 mm	LONGEUR	PROFONDEUR	CODE ARTICLE	Puissance (W) 75/65/20°C	Puissance (W) 55/45/20°C	VOLUME (l)	EXPOSANT N	POIDS (kg)
	2000	105	22DM600 2000	3338	1686	0.0	1.34	71.6
	2200	105	22DM600 2200	3672	1855	0.0	1.34	78.6
	2400	105	22DM600 2400	4006	2023	0.0	1.34	85.5
	2600	105	22DM600 2600	4339	2192	0.0	1.34	92.4
	2800	105	22DM600 2800	4673	2360	0.0	1.34	101.7
	3000	105	22DM600 3000	5007	2529	0.0	1.34	108.8
<b>Type 33</b>								
	400	166	33DM600 0400	967	489	0.0	1.33	22.6
	520	166	33DM600 0520	1257	636	0.0	1.33	28.0
	600	166	33DM600 0600	1451	734	0.0	1.33	32.0
	720	166	33DM600 0720	1741	881	0.0	1.33	37.9
	800	166	33DM600 0800	1934	979	0.0	1.33	41.9
	920	166	33DM600 0920	2225	1126	0.0	1.33	47.9
	1000	166	33DM600 1000	2418	1224	0.0	1.33	51.9
	1120	166	33DM600 1120	2708	1370	0.0	1.33	57.8
	1200	166	33DM600 1200	2902	1468	0.0	1.33	61.8
	1320	166	33DM600 1320	3192	1615	0.0	1.33	67.7
	1400	166	33DM600 1400	3385	1713	0.0	1.33	71.8



# 600

HAUTEUR 600 mm	LONGEUR	PROFONDEUR	CODE ARTICLE	Puissance (W) 75/65/20°C	Puissance (W) 55/45/20°C	VOLUME (l)	EXPOSANT N	POIDS (kg)
	1600	166	33DM600 1600	3869	1958	0.0	1.33	81.8
	1800	166	33DM600 1800	4352	2202	0.0	1.33	91.9
	2000	166	33DM600 2000	4836	2447	0.0	1.33	103.6
	2200	166	33DM600 2200	5320	2692	0.0	1.33	111.7



## 750

HAUTEUR 750 mm	LONGEUR	PROFONDEUR	CODE ARTICLE	Puissance (W) 75/65/20°C	Puissance (W) 55/45/20°C	VOLUME (l)	EXPOSANT N	POIDS (kg)
<b>Type 11</b>								
	400	63	11DM750 0400	415	213	0.0	1.30	12.1
	520	63	11DM750 0520	539	277	0.0	1.30	15.3
	600	63	11DM750 0600	622	320	0.0	1.30	17.4
	720	63	11DM750 0720	747	384	0.0	1.30	2.6
	800	63	11DM750 0800	830	427	0.0	1.30	22.7
	920	63	11DM750 0920	954	491	0.0	1.30	25.8
	1000	63	11DM750 1000	1037	534	0.0	1.30	27.9
	1120	63	11DM750 1120	1161	598	0.0	1.30	31.1
	1200	63	11DM750 1200	1244	640	0.0	1.30	33.2
	1320	63	11DM750 1320	1369	704	0.0	1.30	36.5
	1400	63	11DM750 1400	1452	747	0.0	1.30	38.6
	1600	63	11DM750 1600	1659	854	0.0	1.30	43.9
<b>Type 21</b>								
	400	80	21DM750 0400	604	310	0.0	1.30	17.3
	520	80	21DM750 0520	785	404	0.0	1.30	21.9
	600	80	21DM750 0600	906	466	0.0	1.30	25.0
	720	80	21DM750 0720	1087	559	0.0	1.30	29.6
	800	80	21DM750 0800	1208	621	0.0	1.30	32.7
	920	80	21DM750 0920	1389	714	0.0	1.30	37.4
	1000	80	21DM750 1000	1510	776	0.0	1.30	4.4
	1120	80	21DM750 1120	1691	869	0.0	1.30	45.6
	1200	80	21DM750 1200	1812	931	0.0	1.30	48.1
	1320	80	21DM750 1320	1993	1025	0.0	1.30	52.8



## 750

HAUTEUR 750 mm	LONGEUR	PROFONDEUR	CODE ARTICLE	Puissance (W) 75/65/20°C	Puissance (W) 55/45/20°C	VOLUME (l)	EXPOSANT N	POIDS (kg)
	1400	80	21DM750 1400	2114	1087	0.0	1.30	55.9
<b>Type 22</b>								
	400	105	22DM750 0400	776	393	0.0	1.33	19.9
	520	105	22DM750 0520	1009	511	0.0	1.33	25.3
	600	105	22DM750 0600	1164	589	0.0	1.33	29.0
	720	105	22DM750 0720	1397	707	0.0	1.33	34.4
	800	105	22DM750 0800	1552	786	0.0	1.33	38.6
	920	105	22DM750 0920	1785	903	0.0	1.33	43.6
	1000	105	22DM750 1000	1940	982	0.0	1.33	47.2
	1120	105	22DM750 1120	2173	1100	0.0	1.33	52.7
	1200	105	22DM750 1200	2328	1178	0.0	1.33	56.3
	1320	105	22DM750 1320	2561	1296	0.0	1.33	61.8
	1400	105	22DM750 1400	2716	1375	0.0	1.33	65.5
	1600	105	22DM750 1600	3104	1571	0.0	1.33	74.6



## 900

HAUTEUR 900 mm	LONGEUR	PROFONDEUR	CODE ARTICLE	Puissance (W) 75/65/20°C	Puissance (W) 55/45/20°C	VOLUME (l)	EXPOSANT N	POIDS (kg)
<b>Type 11</b>								
	400	63	11DM900 0400	480	243	0.0	1.33	13.9
	520	63	11DM900 0520	623	316	0.0	1.33	17.6
	600	63	11DM900 0600	719	365	0.0	1.33	20.0
	720	63	11DM900 0720	863	438	0.0	1.33	23.6
	800	63	11DM900 0800	959	487	0.0	1.33	26.8
	920	63	11DM900 0920	1103	560	0.0	1.33	29.7
	1000	63	11DM900 1000	1199	609	0.0	1.33	32.2
	1120	63	11DM900 1120	1343	682	0.0	1.33	35.8
	1200	63	11DM900 1200	1439	730	0.0	1.33	38.3
	1320	63	11DM900 1320	1583	803	0.0	1.33	42.1
	1400	63	11DM900 1400	1679	852	0.0	1.33	44.5
	1600	63	11DM900 1600	1918	974	0.0	1.33	5.5
<b>Type 21</b>								
	400	80	21DM900 0400	708	359	0.0	1.33	2.2
	520	80	21DM900 0520	920	467	0.0	1.33	25.7
	600	80	21DM900 0600	1061	539	0.0	1.33	29.3
	720	80	21DM900 0720	1274	647	0.0	1.33	34.8
	800	80	21DM900 0800	1415	719	0.0	1.33	38.4
	920	80	21DM900 0920	1627	827	0.0	1.33	43.9
	1000	80	21DM900 1000	1769	898	0.0	1.33	47.5
	1120	80	21DM900 1120	1981	1006	0.0	1.33	53.0
	1200	80	21DM900 1200	2123	1078	0.0	1.33	56.6
	1320	80	21DM900 1320	2335	1186	0.0	1.33	62.6



## 900

HAUTEUR 900 mm	LONGEUR	PROFONDEUR	CODE ARTICLE	Puissance (W) 75/65/20°C	Puissance (W) 55/45/20°C	VOLUME (l)	EXPOSANT N	POIDS (kg)
	1400	80	21DM900 1400	2477	1258	0.0	1.33	65.8
<b>Type 22</b>								
	400	105	22DM900 0400	899	451	0.0	1.35	22.9
	520	105	22DM900 0520	1169	587	0.0	1.35	29.1
	600	105	22DM900 0600	1349	677	0.0	1.35	33.3
	720	105	22DM900 0720	1619	813	0.0	1.35	39.6
	800	105	22DM900 0800	1798	903	0.0	1.35	43.8
	920	105	22DM900 0920	2068	1038	0.0	1.35	5.2
	1000	105	22DM900 1000	2248	1129	0.0	1.35	54.4
	1120	105	22DM900 1120	2518	1264	0.0	1.35	6.6
	1200	105	22DM900 1200	2698	1354	0.0	1.35	64.8
	1320	105	22DM900 1320	2967	1490	0.0	1.35	71.1
	1400	105	22DM900 1400	3147	1580	0.0	1.35	75.4
	1600	105	22DM900 1600	3597	1806	0.0	1.35	85.9
<b>Type 33</b>								
	400	166	33DM900 0400	1264	639	0.0	1.34	32.2
	520	166	33DM900 0520	1643	830	0.0	1.34	41.1
	600	166	33DM900 0600	1895	958	0.0	1.34	47.1
	720	166	33DM900 0720	2274	1149	0.0	1.34	56.8



# 900

HAUTEUR 900 mm	LONGEUR	PROFONDEUR	CODE ARTICLE	Puissance (W) 75/65/20°C	Puissance (W) 55/45/20°C	VOLUME (l)	EXPOSANT N	POIDS (kg)
	800	166	33DM900 0800	2527	1277	0.0	1.34	62.6
	920	166	33DM900 0920	2906	1469	0.0	1.34	71.2
	1000	166	33DM900 1000	3159	1596	0.0	1.34	77.1
	1120	166	33DM900 1120	3538	1788	0.0	1.34	86.1
	1200	166	33DM900 1200	3791	1916	0.0	1.34	92.8
	1320	166	33DM900 1320	4170	2107	0.0	1.34	102.7
	1400	166	33DM900 1400	4423	2235	0.0	1.34	108.9