



Tietolehti

2026-06-20

Compact ©

Perinteinen radiaattori 4 x 1/2" liitännöillä, päälliritilällä sekä sivupaneeleilla.

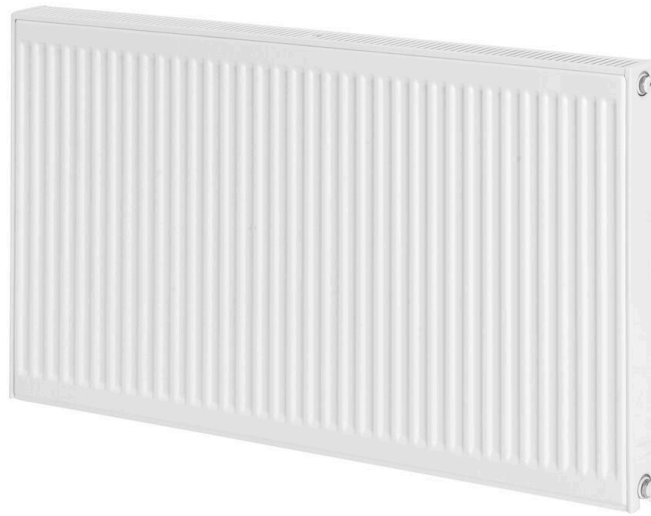

- ✓ Korkea paineenkestävyys
- ✓ Esteettinen muotoilu
- ✓ Monipuoliset asennusvaihtoehdot
- ✓ Tehokas lämmönjako
- ✓ Laaja värivalikoima

Compact on perinteinen paneeliradiaattori suljettuihin vesikiertoisiin keskilämmitysjärjestelmiin. Compact-paneeliradiaattorissa on neljä G 1/2" -liitintä sisäkierteellä, mikä mahdollistaa sivuliitännän oikealta ja vasemmalta puolelta. Korkealaatuinen radiaattori, laadukas viimeistely ja markkinoiden laajin valikoima. Compact on suunniteltu optimaaliseen lämpösäteilyyn standardin EN442-1 mukaisesti ja kaikki mallit ovat CE-merkittyjä. Compact toimitetaan asennetuilla sivupaneeleilla, yläritilällä ja lapsiturvallisella kiinnityksellä. Toimitukseen sisältyvät kiinnikkeet, ritilät, sivupaneelit. Käyttöolosuhteet/-ympäristö on otettava huomioon ja asennusohjeita on noudatettava asennuksessa. Vakiona valkoinen RAL 9016 (muuta värejä saatavilla lisämaksusta). Takuu-aika on 10 vuotta, ja takuuohjeissa lisätietoa sallituista käyttöympäristöistä.



Käyttöalue

Sopii asuin- ja liikerakennuksiin, joissa tarvitaan korkeita paineasetuksia jopa 10 baaria. Ihanteellinen monikerroksisiin rakennuksiin, kaukolämpöjärjestelmiin ja suurempiin asennuksiin. Yhteensopiva järjestelmien kanssa, joiden enimmäiskäyttölämpötila on 110°C ja varustettu pystysuorilla vesikanavilla 33.3 mm välein tehokasta lämmönjakelua varten.

Mitoitus

Käytä suunnittelupalveluamme yksityiskohtaiseen valintaan tai katso esitteestämme nopeaa valintaa varten.

Käyttö

Varmista, että asennus tehdään mukana toimitetuilla MCW-7 seinäkiinnikkeillä vakauden takaamiseksi. Jäähdyttimen liitännät tehdään 4 x G 1/2" sivuaukkojen kautta. Säännöllinen huolto on tarpeen optimaalisen suorituskyvyn varmistamiseksi. Suurimmat

käyttöparametrit ovat 10 baarin työpaine ja 110°C toimintalämpötila.

Suunnittelijan teksti

Purmon Compact (33.3) -radiaattori on suunniteltu korkeapaineesisiin kohteisiin, joiden suurin käyttöpaine on 10 baaria ja suurin käyttölämpötila 110 °C. Siinä on EN 10130 -standardin mukainen syvävedetty, vähähiilinen kylmävalssattu teräs. Tässä radiaattorissa on 33,3 mm:n välein pystysuorat vesikanavat, jotka jakavat lämpöä tehokkaasti, ja se on viimeistelty valmiiksi esiasennetuilla sivupaneeleilla ja yläsäleiköllä. Vakiovärinä valkoinen RAL 9016, muita väri vaihtoehtoja on saatavana pyynnöstä. Liitännät tehdään 4 x G 1/2" sivuaukkojen kautta, ja radiaattorin mukana toimitetaan seinäkiinnityskannattimet, tulpat ja tuuletusaukko. Saatavana useina eri kokoina, se palvelee sekä asuin- että kaupallisia tarpeita ja sopii saumattomasti monikerroksisiin rakennuksiin ja kaukolämpöjärjestelmiin.



Määrittelyt

| OMINAISUUDET | YKSIKKÖ | ARVOT |
|---|---------|----------------|
| ETIM-luokka | | EC011022 |
| Materiaali | | teräs |
| Tyyppi | | 11, 21, 22, 33 |
| Pintarakenne | | profiloitu |
| Suurin käyttöpaine | bar | 10 |
| Vakioliitäntöjen määrä | | 4 |
| Lämmitysteho EN 442 -hyväksytyn laboratorion mukaan | | Kyllä |
| Maksimi käyttölämpötila | °C | 110 |
| Vakioväri | | Kyllä |
| Väri | | valkoinen |
| RAL-numero | | 9016 |
| Säleikkö/Peitelevy | | Kyllä |
| Säleikkö/Peitelevy | | Kyllä |
| Kiiltoaste | | kiiltävä |
| Kierrekoko (tuuma) | | 1/2" |
| Liitäntä kierre | | sisäkierre |
| Yhden pisteen liitännällä | | Kyllä |
| Ilmausliitännällä | | Kyllä |
| Ilmausventtiilillä/ilmaajalla | | Kyllä |
| Tyhjennysmahdollisuudella | | Kyllä |



Dokumentit

| DOKUMENTIT | DOKUMENTTITYYPPI | LINKKI |
|---|------------------|---|
| PURMO - radiaattorivalikoiman tekninen esite, 2018 | ProductCatalog | https://asset.productmarketingcloud.com/api/assetstorage/3577_ed398445-293c-4d35-be10-ab31eca9c1cb |
| Värikartta 2025 | Brochure | https://asset.productmarketingcloud.com/api/assetstorage/3577_190325f8-8b3b-4b3a-84d1-15ae17bd0b59 |
| Takuehdot, Purmo radiaattorit ja konvektorit | Warranty | https://asset.productmarketingcloud.com/api/assetstorage/3577_00ce510b-77ef-40a3-9b7e-bfc12453a5a3 |
| Asennus- ja Huolto ohje, Paneeliradiaattorit | Installation | https://asset.productmarketingcloud.com/api/assetstorage/3577_2f8590e0-d2e8-4d65-bd59-843321666e62 |
| Tiivyskoe, ohjeet ja pöytäkirja - radiaattorit ja konvektorit FI-SE | Installation | https://asset.productmarketingcloud.com/api/assetstorage/3577_c339a119-c7a0-46c2-a699-964efbdd617a |
| Purmo Teholaskenta, Paneeliradiaattorit (DE) | TechDia | https://asset.productmarketingcloud.com/api/assetstorage/3577_2da398bb-5820-4a58-af2d-623333aa4e65e |



Resurssit



ProductImage - Purmo Compact, C, detail above.

ProductImage - Purmo Compact, C, product image 30 degrees.

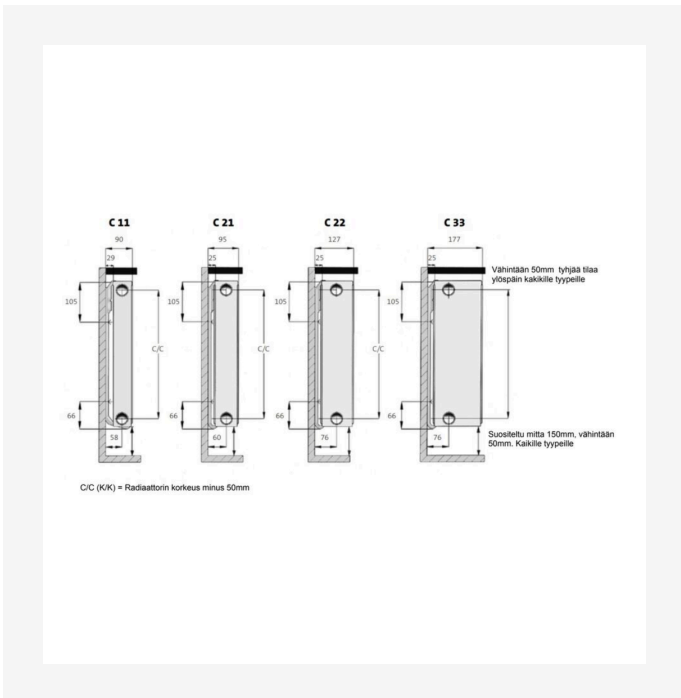

DimensionalDrawing - Radiaattorin kannakointiohje

| COMPACT (mm) | | | | |
|--------------|-----|------|----------------|------|
| | C11 | | C21s, C22, C33 | |
| A | a1 | a2 | a1 | a2 |
| 400-1600 | 117 | - | 133 | - |
| 1800 | 117 | 917 | 133 | 900 |
| 2000 | 117 | 1017 | 133 | 1000 |
| 2300 | 117 | 1150 | 133 | 1167 |
| 2600 | 117 | 1317 | 133 | 1300 |
| 3000 | 117 | 1517 | 133 | 1500 |

DimensionalDrawing - Compact, taulukkopiirros A



Resurssit

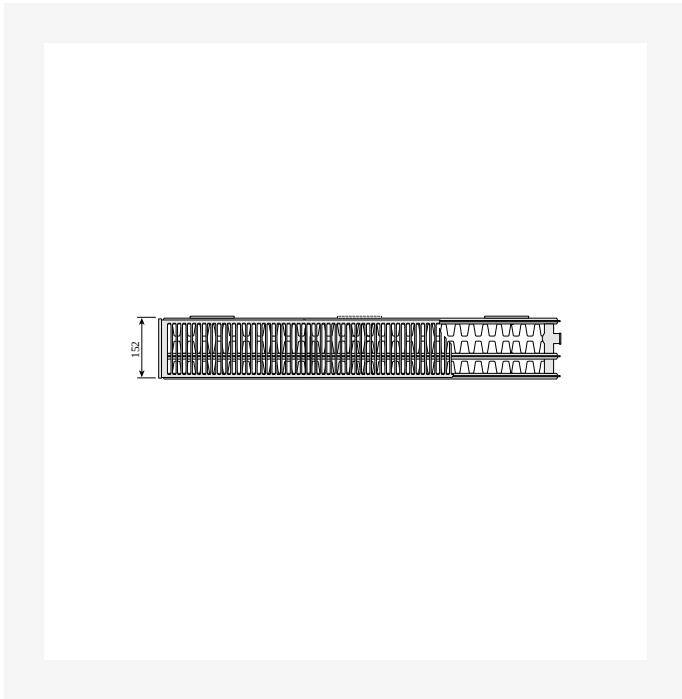

DimensionalDrawing - Compact, tyyppi 33, ylhäältäpäin

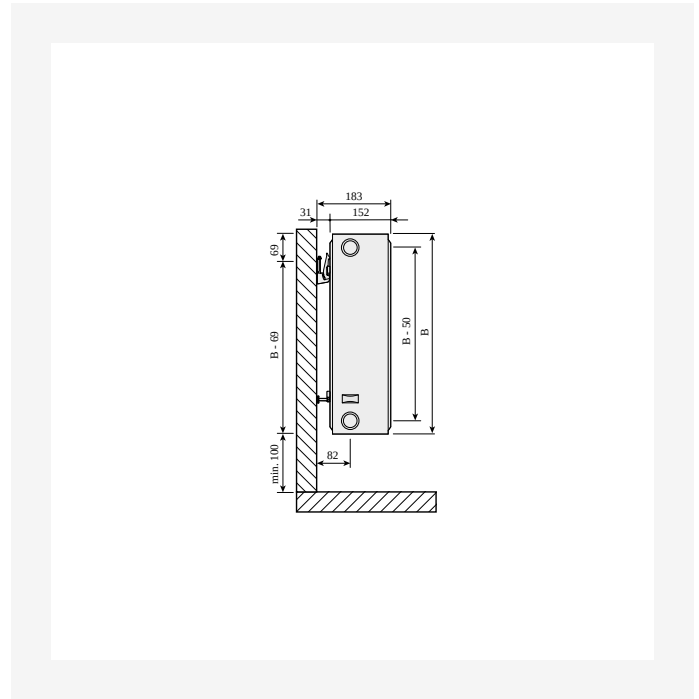

DimensionalDrawing - Compact, tyyppi 33, sivunäkymä SSMS-seinäkannakkeilla

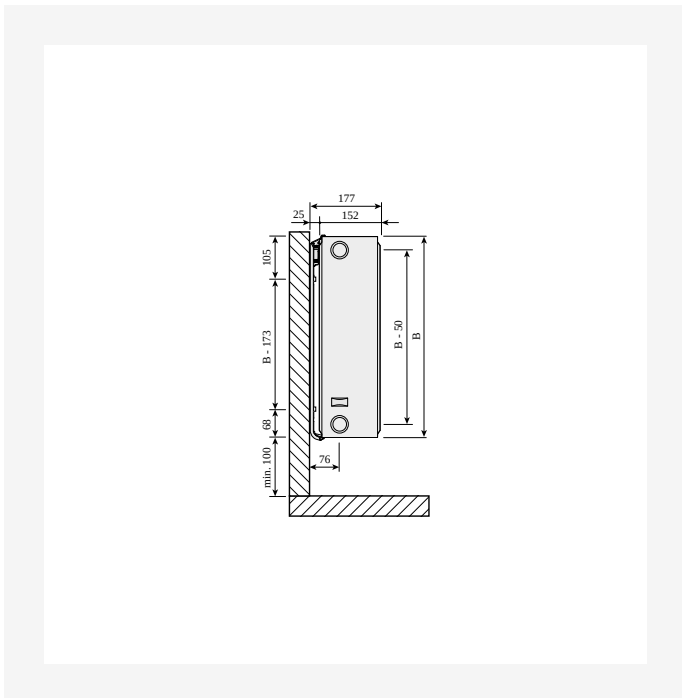

DimensionalDrawing - Compact, tyyppi 33, sivunäkymä Monclac-seinäkannakkeilla

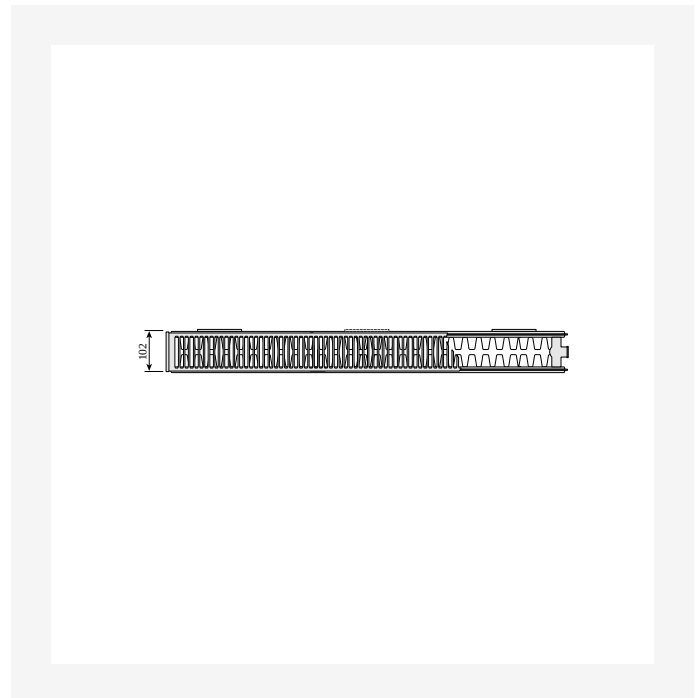

DimensionalDrawing - Compact, tyyppi 22, ylhäältäpäin



Resurssit

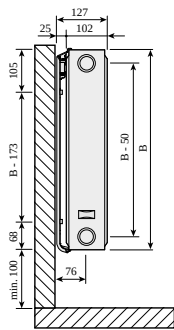

DimensionalDrawing - Compact, tyyppi 22, sivunäkymä Monclac-seinäkannakkeilla

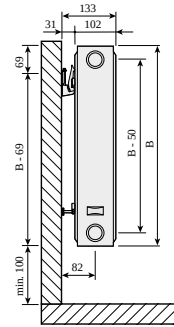

DimensionalDrawing - Compact, tyyppi 22, sivunäkymä SSMS-seinäkannakkeilla



DimensionalDrawing - Compact, tyyppi 21, ylhäältäpäin

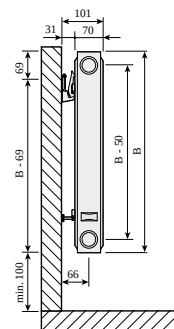

DimensionalDrawing - Compact, tyyppi 21, sivunäkymä SSMS-seinäkannakkeilla



Resurssit

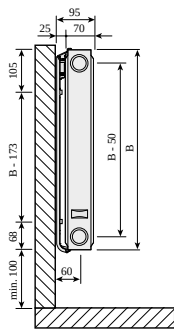

DimensionalDrawing - Compact, tyyppi 21, sivunäkymä Monclac-seinäkannakkeilla

DimensionalDrawing - Compact, tyyppi 11, ylhäältäpäin

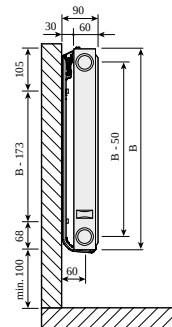
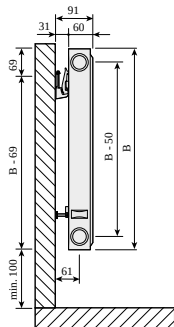

DimensionalDrawing - Compact, tyyppi 11, sivunäkymä SSMS-seinäkannakkeilla

DimensionalDrawing - Compact, tyyppi 11, sivunäkymä Monclac-seinäkannakkeilla



Resurssit

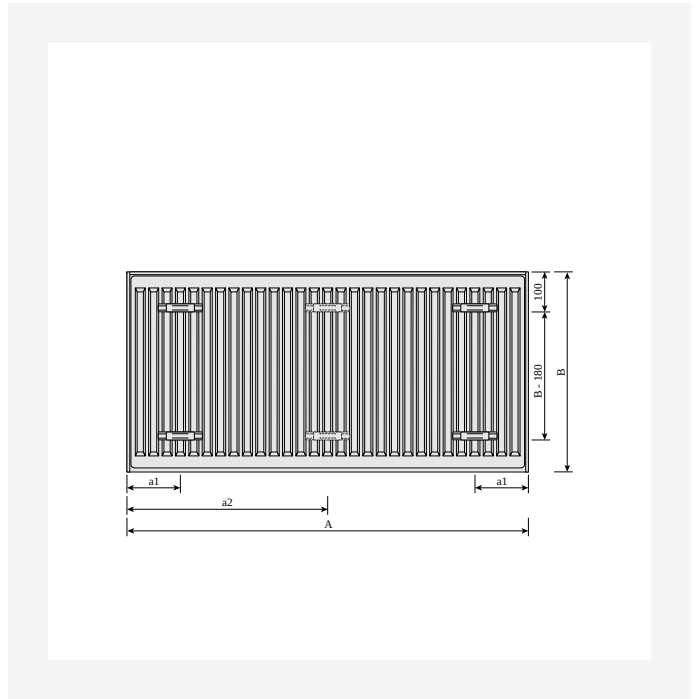
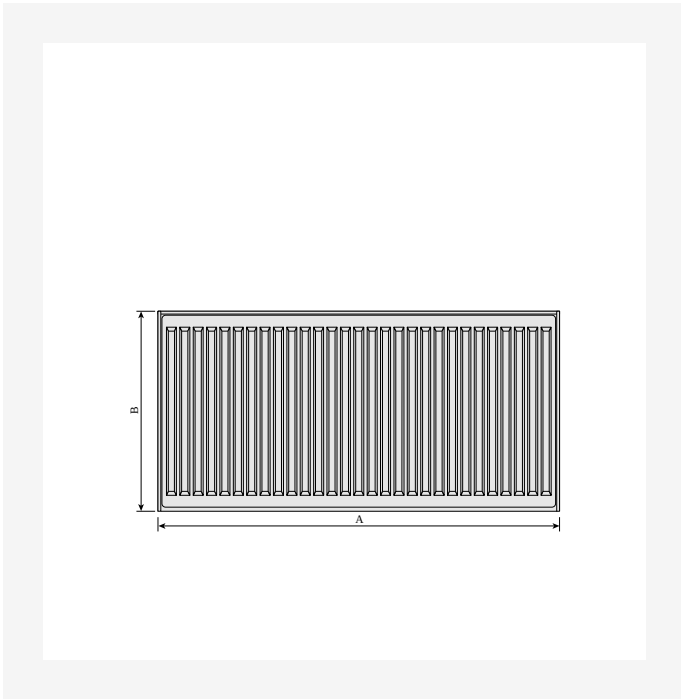

DimensionalDrawing - Compact, etunäkymä

DimensionalDrawing - Compact, takaa

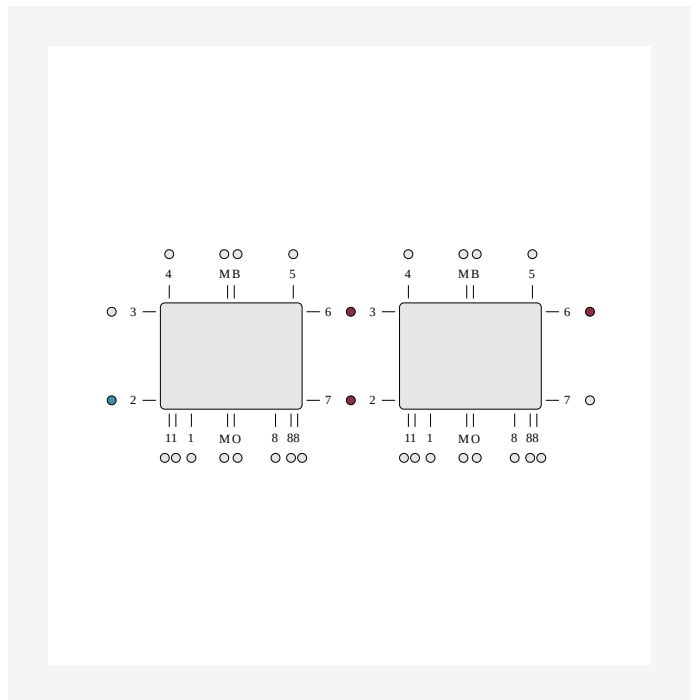
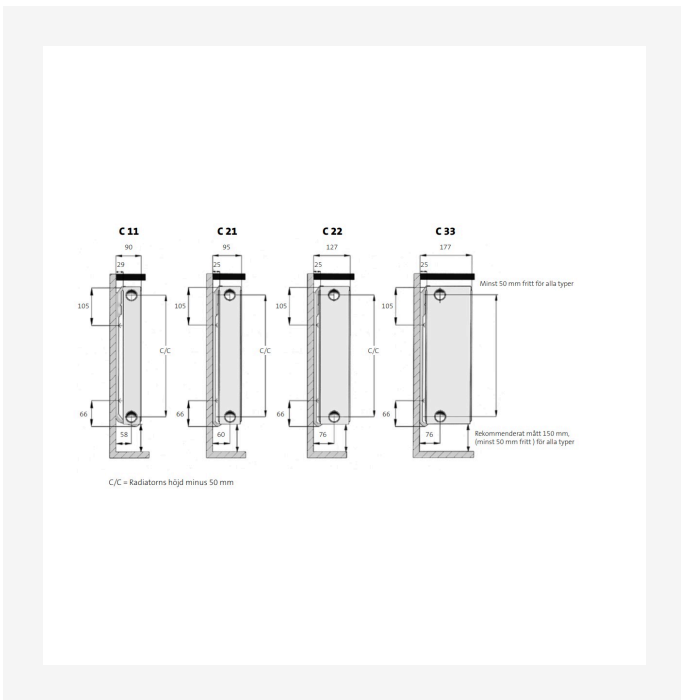

DimensionalDrawing - Asennusmitat

DimensionalDrawing - ETIM 62 Sarjaankytkentä vaakasuora liitäntä

Resurssit

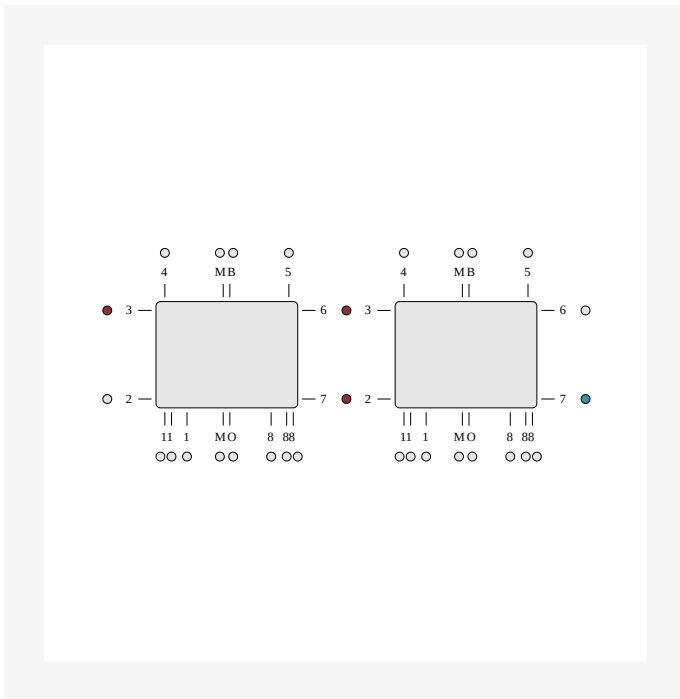

DimensionalDrawing - ETIM 37 Sarjaankytkentä vaakasuora liitäntä

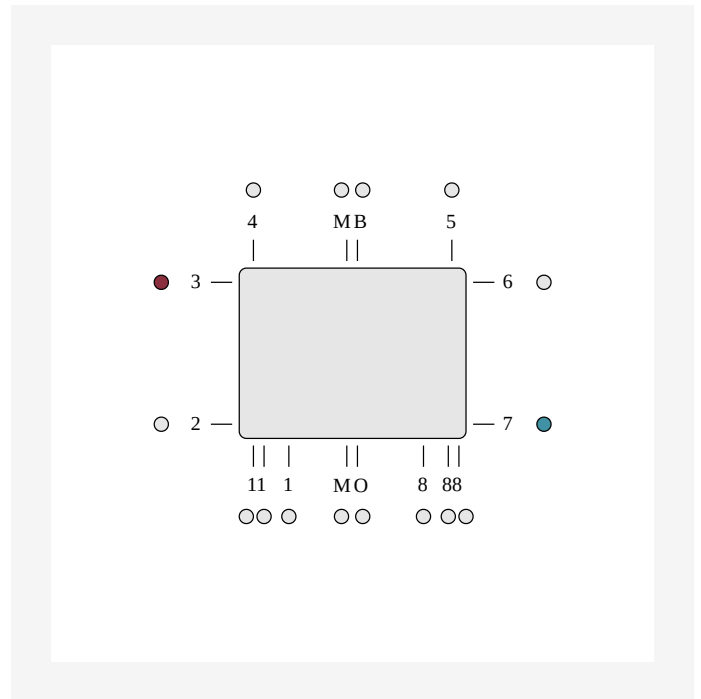

DimensionalDrawing - Diagonaaliliitäntä ETIM 37. Diagonaaliliitäntä edellyttää ulkoisen venttiilin käyttöä. Diagonaaliliitännässä alaliitännät on tulpattu.

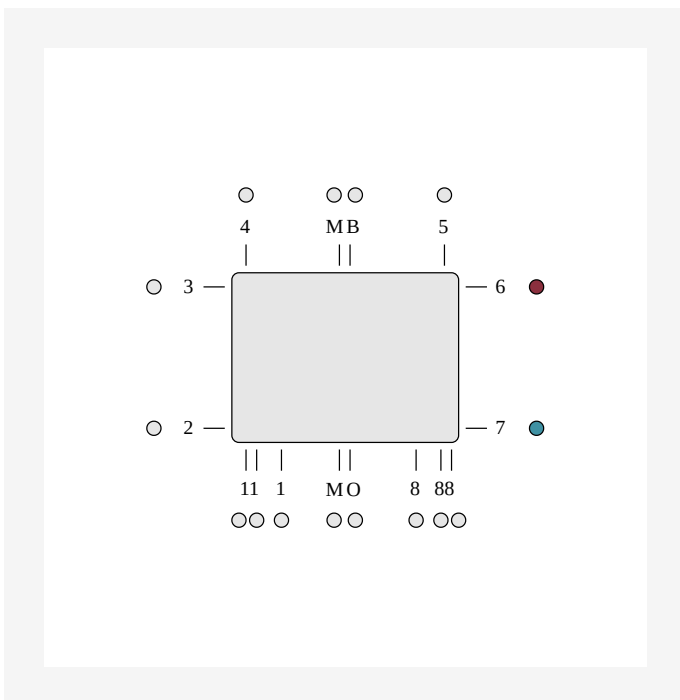

DimensionalDrawing - Sivuliitäntä ETIM 67. Sivuliitäntä edellyttää ulkoisen patteriliittimen tai venttiilin käyttöä. Sivuliitännän tapauksessa alaosien liitännät tulpataan.

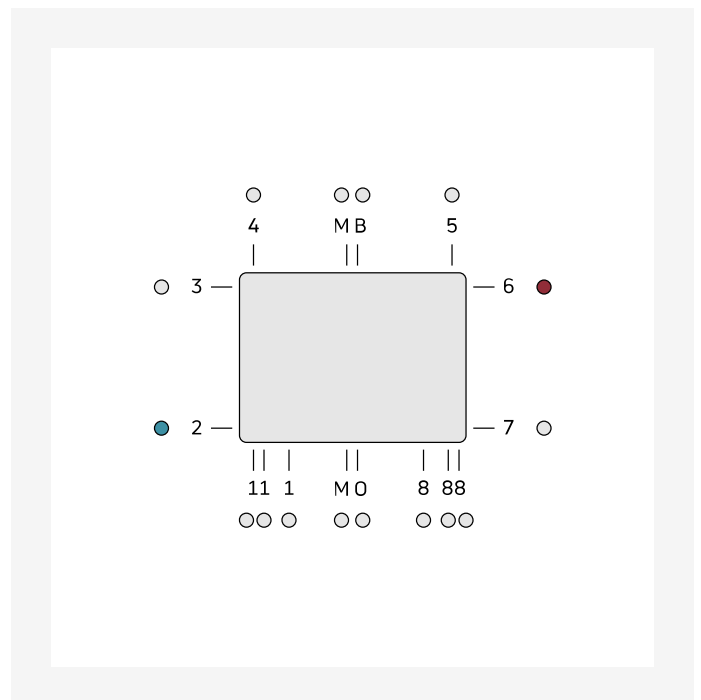

DimensionalDrawing - Diagonaaliliitäntä ETIM 62. Diagonaaliliitäntä edellyttää ulkoisen venttiilin käyttöä. Diagonaaliliitännän tapauksessa alaosien liitännät tulpataan.



Resurssit

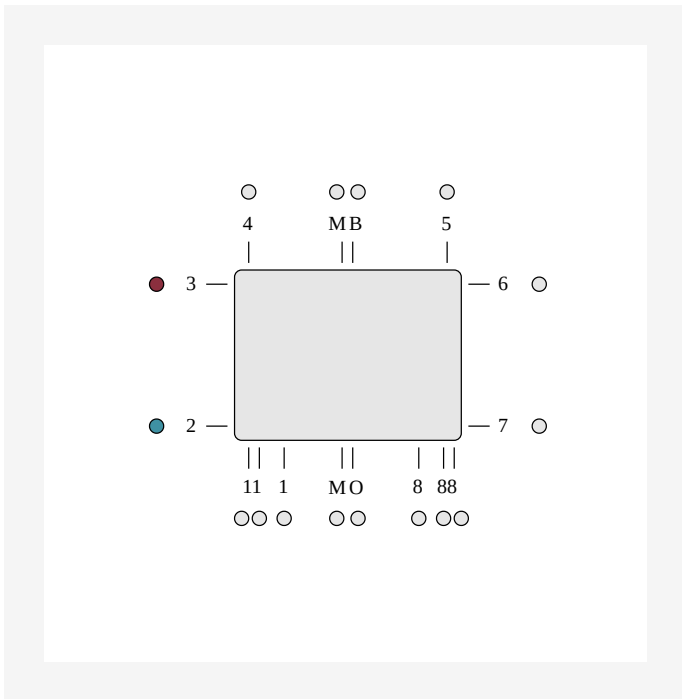

DimensionalDrawing - Sivuliitäntä ETIM 32. Sivuliitäntä edellyttää ulkoisen patteriventtiilin käyttöä. Sivuliitäntän tapauksessa alaosien liitännät tulpataan.



Liittyvät tuotteet



Anturi



Päälliritilä



Air



Ilmausruuvi- ja
umpitulppasarja 1/2"



Korjausmaali Tipex



Sivupaneeli



Ilmausventtiili 1/2"



Seinäkannake Monclac MCA



Ilmausavain



Radiaattorin puhdistusharja



Flex-radiaattoriliitäntä

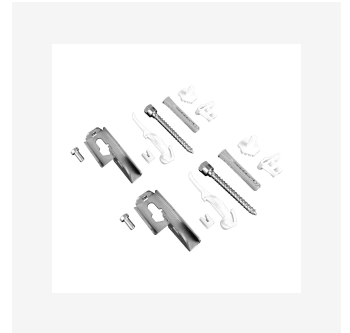

Pikakannake Quick (SSMS)



Liittyvät tuotteet



Lukituslpa, C ja TP



Evosense-termostaattipää



Paluuventtiili RV

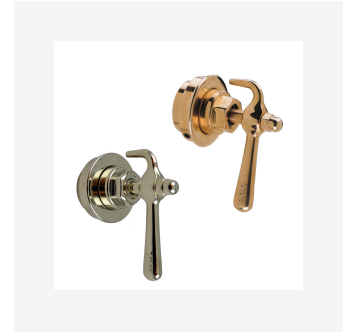

Kartano-radiaattoriventtiilin käsisäätökahva



Evosense Sprint -
termostaattipää



Jalkakannakesuoja



Evoflow-radiaattoriventtiili



Kartano-radiaattoriventtiili (FV)



Evosense Public -
termostaattipää



Purmo Monclac -lattiautuki



Kartano-paluuventtiili (RV)

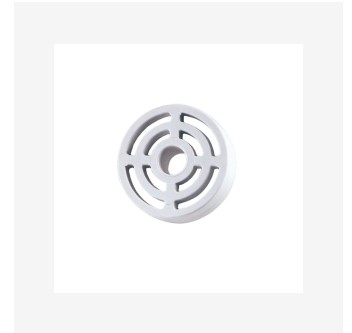

Seinäholkki



Liittyvät tuotteet



Evosense Remote -
termostaattipää

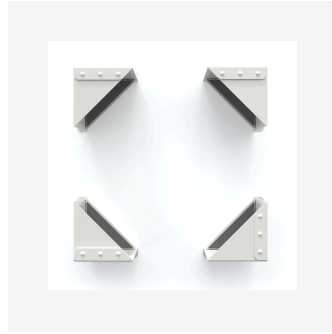

Turvakannake



300

| KORKEUS 300 mm | PITUUS | SYVYYS | Tuoteno/ LVI (VASEN) | Tuoteno/ LVI (OIKEA) | TEHO (W) 45/35/20°C | TEHO (W) 55/45/20°C | TEHO (W) 60/45/20°C | TILAVUUS (l) | N- eksponentti | PAINO (kg) |
|-------------------|--------|--------|-------------------------|----------------------------|------------------------|------------------------|------------------------|-----------------|-------------------|---------------|
| Tyyppi 11 | | | | | | | | | | |
| 400 | 60 | | 5418202 | | 65 | 113 | 122 | 0.7 | 1.30 | 4.4 |
| 500 | 60 | | 5418203 | | 81 | 141 | 152 | 0.8 | 1.30 | 5.1 |
| 600 | 60 | | 5418204 | | 97 | 169 | 183 | 1.0 | 1.30 | 5.9 |
| 700 | 60 | | F061103007010300 | 5418205 | 113 | 197 | 213 | 1.2 | 1.30 | 6.7 |
| 800 | 60 | | F061103008010300 | 5418206 | 129 | 225 | 244 | 1.4 | 1.30 | 7.5 |
| 900 | 60 | | F061103009010300 | 5418207 | 146,145 | 253 | 274 | 1.5 | 1.30 | 8.3 |
| 1000 | 60 | | 5418208 | | 162 | 281 | 305 | 1.7 | 1.30 | 9.2 |
| 1100 | 60 | | F061103011010300 | 5418209 | 178 | 309 | 336,335 | 1.9 | 1.30 | 10.0 |
| 1200 | 60 | | F061103012010300 | 5418210 | 194 | 338 | 366 | 2.0 | 1.30 | 1.6 |
| 1400 | 60 | | 5418212 | | 226 | 394 | 427 | 2.4 | 1.30 | 12.2 |
| 1600 | 60 | | F061103016010300 | 5418213 | 259 | 450 | 488 | 2.7 | 1.30 | 13.8 |
| 1800 | 60 | | 5418214 | | 291 | 506 | 549 | 3.1 | 1.30 | 15.4 |
| 2000 | 60 | | 5418215 | | 323 | 563 | 610 | 3.4 | 1.30 | 17.0 |
| 2300 | 60 | | 5418216 | | 372 | 647 | 701 | 3.9 | 1.30 | 19.4 |
| 2600 | 60 | | F061103026010300 | 5418217 | 420 | 731 | 793,792 | 4.4 | 1.30 | 21.7 |
| 3000 | 60 | | 5418218 | | 485 | 844 | 915 | 5.1 | 1.30 | 24.9 |
| Tyyppi 21 | | | | | | | | | | |
| 400 | 70 | | F062103004010300 | 5418402 | 92 | 158 | 171 | 1.4 | 1.28 | 6.2 |
| 500 | 70 | | 5418403 | | 115 | 198 | 214 | 1.7 | 1.28 | 7.4 |
| 600 | 70 | | 5418404 | | 138 | 237 | 257 | 2.0 | 1.28 | 8.6 |
| 700 | 70 | | 5418405 | | 160 | 277 | 300 | 2.4 | 1.28 | 10.0 |
| 800 | 70 | | 5418406 | | 183 | 317 | 343 | 2.7 | 1.28 | 11.3 |
| 900 | 70 | | 5418407 | | 206 | 356 | 386 | 3.1 | 1.28 | 12.3 |
| 1000 | 70 | | 5418408 | | 229 | 396 | 428 | 3.4 | 1.28 | 13.6 |



300

| KORKEUS 300 mm | PITUUS | SYVYYS | Tuoteno/ LVI (VASEN) | Tuoteno/ LVI (OIKEA) | TEHO (W) 45/35/20°C | TEHO (W) 55/45/20°C | TEHO (W) 60/45/20°C | TILAVUUS (l) | N- eksponentti | PAINO (kg) |
|-------------------|--------|--------|-------------------------|----------------------------|------------------------|------------------------|------------------------|-----------------|-------------------|---------------|
| | 1100 | 70 | F062103011010300 | 5418409 | 252 | 435 | 471 | 3.7 | 1.28 | 14.8 |
| | 1200 | 70 | | 5418410 | 275 | 475 | 514 | 4.1 | 1.28 | 16.4 |
| | 1400 | 70 | F062103014010300 | 5418412 | 321 | 554 | 600,599 | 4.8 | 1.28 | 18.7 |
| | 1600 | 70 | | 5418413 | 367 | 633 | 686 | 5.4 | 1.28 | 21.1 |
| | 1800 | 70 | F062103018010300 | 5418414 | 412 | 712 | 771 | 6.1 | 1.28 | 23.6 |
| | 2000 | 70 | | 5418415 | 458 | 791 | 857 | 6.8 | 1.28 | 26.1 |
| | 2300 | 70 | | 5418416 | 527 | 910 | 985 | 7.8 | 1.28 | 30.0 |
| | 2600 | 70 | | 5418417 | 596 | 1029 | 1114 | 8.8 | 1.28 | 33.7 |
| | 3000 | 70 | | 5418418 | 687 | 1187 | 1285 | 10.2 | 1.28 | 38.7 |
| Tyyppi 22 | | | | | | | | | | |
| | 400 | 102 | | 5418602 | 112 | 197 | 213 | 1.4 | 1.31 | 7.2 |
| | 500 | 102 | | 5418603 | 141 | 246 | 267 | 1.7 | 1.31 | 8.5 |
| | 600 | 102 | F062203006010300 | 5418604 | 169 | 295 | 321,320 | 2.0 | 1.31 | 10.1 |
| | 700 | 102 | F062203007010300 | 5418605 | 197 | 345 | 374 | 2.4 | 1.31 | 11.4 |
| | 800 | 102 | | 5418606 | 225 | 394 | 427 | 2.7 | 1.31 | 12.8 |
| | 900 | 102 | | 5418607 | 253 | 443 | 481 | 3.1 | 1.31 | 14.2 |
| | 1000 | 102 | | 5418608 | 282 | 492 | 534 | 3.4 | 1.31 | 15.6 |
| | 1100 | 102 | F062203011010300 | 5418609 | 310 | 542 | 587 | 3.7 | 1.31 | 17.4 |
| | 1200 | 102 | | 5418610 | 338 | 591 | 641 | 4.1 | 1.31 | 18.5 |
| | 1400 | 102 | | 5418612 | 394 | 689 | 747 | 4.8 | 1.31 | 21.3 |
| | 1600 | 102 | F062203016010300 | 5418613 | 451 | 788 | 854 | 5.4 | 1.31 | 24.2 |
| | 1800 | 102 | | 5418614 | 507 | 886 | 961 | 6.1 | 1.31 | 27.1 |
| | 2000 | 102 | F062203020010300 | 5418615 | 563 | 985 | 1068,1067 | 6.8 | 1.31 | 29.9 |
| | 2300 | 102 | | 5418616 | 647 | 1132 | 1228 | 7.8 | 1.31 | 34.1 |
| | 2600 | 102 | | 5418617 | 732 | 1280 | 1388 | 8.8 | 1.31 | 38.5 |



300

| KORKEUS 300 mm | PITUUS | SYVYYS | Tuotenro/ LVI (VASEN) | Tuotenro/ LVI (OIKEA) | TEHO (W) 45/35/20°C | TEHO (W) 55/45/20°C | TEHO (W) 60/45/20°C | TILAVUUS (l) | N- eksponentti | PAINO (kg) |
|-------------------|--------|--------|--------------------------|-----------------------------|------------------------|------------------------|------------------------|-----------------|-------------------|---------------|
| | 3000 | 102 | F062203030010300 | 5418618 | 845 | 1477 | 1602,1601 | 10.2 | 1.31 | 44.9 |
| Tyyppi 33 | | | | | | | | | | |
| | 400 | 152 | | 5418802 | 157 | 275 | 299 | 2.0 | 1.31 | 1.3 |
| | 500 | 152 | | 5418803 | 197 | 344 | 374 | 2.5 | 1.31 | 12.4 |
| | 600 | 152 | | 5418804 | 236 | 413 | 448 | 3.1 | 1.31 | 14.5 |
| | 700 | 152 | F063303007010300 | 5418805 | 275 | 482 | 523 | 3.6 | 1.31 | 16.7 |
| | 800 | 152 | | 5418806 | 314 | 551 | 598 | 4.1 | 1.31 | 18.8 |
| | 900 | 152 | F063303009010300 | 5418807 | 354,353 | 620 | 672 | 4.6 | 1.31 | 2.9 |
| | 1000 | 152 | | 5418808 | 393 | 688 | 747 | 5.1 | 1.31 | 23.5 |
| | 1100 | 152 | F063303011010300 | 5418809 | 432 | 757 | 822,821 | 5.6 | 1.31 | 25.2 |
| | 1200 | 152 | | 5418810 | 471 | 826 | 896 | 6.1 | 1.31 | 27.3 |
| | 1400 | 152 | | 5418812 | 550 | 964 | 1046 | 7.1 | 1.31 | 31.6 |
| | 1600 | 152 | | 5418813 | 629 | 1101 | 1195 | 8.2 | 1.31 | 35.8 |
| | 1800 | 152 | | 5418814 | 707 | 1239 | 1344 | 9.2 | 1.31 | 4.7 |
| | 2000 | 152 | F063303020010300 | 5418815 | 786 | 1377 | 1493 | 10.2 | 1.31 | 44.3 |
| | 2300 | 152 | F063303023010300 | 5418816 | 904 | 1583 | 1717 | 11.7 | 1.31 | 5.7 |
| | 2600 | 152 | | 5418817 | 1021 | 1790 | 1941 | 13.3 | 1.31 | 57.9 |
| | 3000 | 152 | F063303030010300 | 5418818 | 1179 | 2065 | 2240 | 15.3 | 1.31 | 65.6 |



400

| KORKEUS 400 mm | PITUUS | SYVYYS | Tuoteno/ LVI (VASEN) | Tuoteno/ LVI (OIKEA) | TEHO (W) 45/35/20°C | TEHO (W) 55/45/20°C | TEHO (W) 60/45/20°C | TILAVUUS (l) | N- eksponentti | PAINO (kg) |
|-------------------|--------|------------------|-------------------------|----------------------------|------------------------|------------------------|------------------------|-----------------|-------------------|---------------|
| Tyyppi 11 | | | | | | | | | | |
| 400 | 60 | | 5418222 | | 84 | 146 | 158 | 0.9 | 1.30 | 5.5 |
| 500 | 60 | F061104005010300 | 5418223 | | 105 | 183 | 198 | 1.1 | 1.30 | 6.5 |
| 600 | 60 | F061104006010300 | 5418224 | | 126 | 219 | 238 | 1.3 | 1.30 | 7.6 |
| 700 | 60 | | 5418225 | | 147 | 256 | 277 | 1.5 | 1.30 | 8.7 |
| 800 | 60 | F061104008010300 | 5418226 | | 168 | 292 | 317 | 1.8 | 1.30 | 9.7 |
| 900 | 60 | | 5418227 | | 189 | 329 | 357 | 2.0 | 1.30 | 1.8 |
| 1000 | 60 | F061104010010300 | 5418228 | | 210 | 366 | 396 | 2.2 | 1.30 | 11.8 |
| 1100 | 60 | F061104011010300 | 5418229 | | 231 | 402 | 436 | 2.4 | 1.30 | 12.9 |
| 1200 | 60 | | 5418230 | | 251 | 439 | 475 | 2.6 | 1.30 | 14.0 |
| 1400 | 60 | | 5418232 | | 293 | 512 | 554 | 3.1 | 1.30 | 16.1 |
| 1600 | 60 | | 5418233 | | 335 | 585 | 634 | 3.5 | 1.30 | 18.2 |
| 1800 | 60 | | 5418234 | | 377 | 658 | 713 | 4.0 | 1.30 | 2.4 |
| 2000 | 60 | F061104020010300 | 5418235 | | 419 | 731 | 792 | 4.4 | 1.30 | 22.5 |
| 2300 | 60 | | 5418236 | | 482 | 841 | 911 | 5.1 | 1.30 | 25.7 |
| 2600 | 60 | F061104026010300 | 5418237 | | 545 | 950 | 1030 | 5.7 | 1.30 | 28.9 |
| 3000 | 60 | | 5418238 | | 629 | 1097 | 1189 | 6.6 | 1.30 | 33.2 |
| Tyyppi 21 | | | | | | | | | | |
| 400 | 70 | F062104004010300 | 5418422 | | 115,114 | 199 | 215 | 1.8 | 1.29 | 7.7 |
| 500 | 70 | F062104005010300 | 5418423 | | 143 | 249 | 270,269 | 2.3 | 1.29 | 9.4 |
| 600 | 70 | | 5418424 | | 172 | 298 | 323 | 2.7 | 1.29 | 11.1 |
| 700 | 70 | F062104007010300 | 5418425 | | 200 | 348 | 377 | 3.1 | 1.29 | 12.8 |
| 800 | 70 | F062104008010300 | 5418426 | | 229 | 398 | 431 | 3.6 | 1.29 | 14.5 |
| 900 | 70 | | 5418427 | | 258 | 448 | 485 | 4.0 | 1.29 | 16.2 |
| 1000 | 70 | | 5418428 | | 286 | 497 | 539 | 4.5 | 1.29 | 17.9 |



400

| KORKEUS 400 mm | PITUUS | SYVYYS | Tuotenro/ LVI (VASEN) | Tuotenro/ LVI (OIKEA) | TEHO (W) 45/35/20°C | TEHO (W) 55/45/20°C | TEHO (W) 60/45/20°C | TILAVUUS (l) | N- eksponentti | PAINO (kg) |
|-------------------|--------|--------|--------------------------|-----------------------------|------------------------|------------------------|------------------------|-----------------|-------------------|---------------|
| | 1100 | 70 | F062104011010300 | 5418429 | 315 | 547 | 592 | 5.0 | 1.29 | 19.6 |
| | 1200 | 70 | F062104012010300 | 5418430 | 344 | 597 | 647,646 | 5.4 | 1.29 | 21.3 |
| | 1400 | 70 | 5418432 | | 401 | 696 | 754 | 6.3 | 1.29 | 24.6 |
| | 1600 | 70 | F062104016010300 | 5418433 | 458 | 796 | 862 | 7.2 | 1.29 | 28.3 |
| | 1800 | 70 | F062104018010300 | 5418434 | 515 | 895 | 969 | 8.1 | 1.29 | 31.4 |
| | 2000 | 70 | 5418435 | | 572 | 994 | 1077 | 9.0 | 1.29 | 34.8 |
| | 2300 | 70 | 5418436 | | 658 | 1144 | 1239 | 10.3 | 1.29 | 39.9 |
| | 2600 | 70 | 5418437 | | 744 | 1293 | 1401 | 11.7 | 1.29 | 44.9 |
| | 3000 | 70 | 5418438 | | 859 | 1492 | 1616 | 13.5 | 1.29 | 51.7 |
| Tyyppi 22 | | | | | | | | | | |
| | 400 | 102 | F062204004010300 | 5418622 | 142 | 249 | 270 | 1.8 | 1.32 | 9.2 |
| | 500 | 102 | 5418623 | | 178 | 311 | 338 | 2.3 | 1.32 | 11.3 |
| | 600 | 102 | F062204006010300 | 5418624 | 213 | 374 | 406,405 | 2.7 | 1.32 | 13.3 |
| | 700 | 102 | 5418625 | | 248 | 436 | 473 | 3.1 | 1.32 | 15.0 |
| | 800 | 102 | 5418626 | | 284 | 498 | 541 | 3.6 | 1.32 | 16.9 |
| | 900 | 102 | 5418627 | | 319 | 560 | 608 | 4.0 | 1.32 | 18.8 |
| | 1000 | 102 | 5418628 | | 355 | 623 | 676 | 4.5 | 1.32 | 2.7 |
| | 1100 | 102 | F062204011010300 | 5418629 | 390 | 685 | 743 | 5.0 | 1.32 | 22.6 |
| | 1200 | 102 | 5418630 | | 426 | 747 | 811 | 5.4 | 1.32 | 24.6 |
| | 1400 | 102 | F062204014010300 | 5418632 | 497,496 | 872 | 946 | 6.3 | 1.32 | 28.4 |
| | 1600 | 102 | 5418633 | | 568 | 996 | 1081 | 7.2 | 1.32 | 32.3 |
| | 1800 | 102 | F062204018010300 | 5418634 | 639 | 1121 | 1216 | 8.1 | 1.32 | 36.1 |
| | 2000 | 102 | F062204020010300 | 5418635 | 710,709 | 1245 | 1351 | 9.0 | 1.32 | 40.0 |
| | 2300 | 102 | 5418636 | | 816 | 1432 | 1554 | 10.3 | 1.32 | 45.7 |
| | 2600 | 102 | F062204026010300 | 5418637 | 923,922 | 1619 | 1757,1756 | 11.7 | 1.32 | 51.6 |



400

| KORKEUS 400 mm | PITUUS | SYVYYS | Tuoteno/ LVI (VASEN) | Tuoteno/ LVI (OIKEA) | TEHO (W) 45/35/20°C | TEHO (W) 55/45/20°C | TEHO (W) 60/45/20°C | TILAVUUS (l) | N- eksponentti | PAINO (kg) |
|-------------------|--------|--------|-------------------------|----------------------------|------------------------|------------------------|------------------------|-----------------|-------------------|---------------|
| | 3000 | 102 | 5418638 | | 1064 | 1868 | 2027 | 13.5 | 1.32 | 59.2 |
| Tyyppi 33 | | | | | | | | | | |
| | 400 | 152 | 5418822 | | 196 | 345 | 375 | 2.7 | 1.33 | 13.5 |
| | 500 | 152 | F063304005010300 | 5418823 | 245 | 432 | 469,468 | 3.4 | 1.33 | 16.4 |
| | 600 | 152 | 5418824 | | 294 | 518 | 562 | 4.0 | 1.33 | 19.2 |
| | 700 | 152 | F063304007010300 | 5418825 | 343 | 604 | 656 | 4.7 | 1.33 | 22.1 |
| | 800 | 152 | F063304008010300 | 5418826 | 392 | 691 | 750,749 | 5.4 | 1.33 | 25.0 |
| | 900 | 152 | 5418827 | | 441 | 777 | 843 | 6.0 | 1.33 | 27.9 |
| | 1000 | 152 | F063304010010300 | 5418828 | 490 | 863 | 937 | 6.7 | 1.33 | 3.8 |
| | 1100 | 152 | F063304011010300 | 5418829 | 539 | 950 | 1031 | 7.4 | 1.33 | 33.6 |
| | 1200 | 152 | 5418830 | | 588 | 1036 | 1125 | 8.0 | 1.33 | 36.5 |
| | 1400 | 152 | 5418832 | | 686 | 1209 | 1312 | 9.4 | 1.33 | 42.3 |
| | 1600 | 152 | 5418833 | | 784 | 1381 | 1499 | 10.7 | 1.33 | 48.5 |
| | 1800 | 152 | F063304018010300 | 5418834 | 883,882 | 1554 | 1687,1686 | 12.1 | 1.33 | 53.9 |
| | 2000 | 152 | F063304020010300 | 5418835 | 981,980 | 1726 | 1874 | 13.4 | 1.33 | 59.6 |
| | 2300 | 152 | 5418836 | | 1128 | 1985 | 2155 | 15.4 | 1.33 | 68.2 |
| | 2600 | 152 | 5418837 | | 1274 | 2244 | 2436 | 17.4 | 1.33 | 76.9 |
| | 3000 | 152 | 5418838 | | 1471 | 2590 | 2811 | 20.1 | 1.33 | 88.4 |



450

| KORKEUS 450 mm | PITUUS | SYVYYS | Tuoteno/ LVI (VASEN) | Tuoteno/ LVI (OIKEA) | TEHO (W) 45/35/20°C | TEHO (W) 55/45/20°C | TEHO (W) 60/45/20°C | TILAVUUS (l) | N- eksponentti | PAINO (kg) |
|-------------------|--------|--------|-------------------------|----------------------------|------------------------|------------------------|------------------------|-----------------|-------------------|---------------|
| Tyyppi 11 | | | | | | | | | | |
| | 400 | 60 | | 5418242 | 93 | 162 | 176 | 1.0 | 1.30 | 6.4 |
| | 500 | 60 | | 5418243 | 116 | 203 | 220 | 1.3 | 1.30 | 7.6 |
| | 600 | 60 | F061104506010300 | 5418244 | 139 | 243 | 264 | 1.5 | 1.30 | 8.9 |
| | 700 | 60 | | 5418245 | 163 | 284 | 308 | 1.8 | 1.30 | 1.2 |
| | 800 | 60 | | 5418246 | 186 | 325 | 352 | 2.0 | 1.30 | 11.4 |
| | 900 | 60 | | 5418247 | 209 | 365 | 396 | 2.3 | 1.30 | 12.7 |
| | 1000 | 60 | F061104510010300 | 5418248 | 232 | 406 | 440 | 2.5 | 1.30 | 14.0 |
| | 1100 | 60 | | 5418249 | 256 | 446 | 484 | 2.8 | 1.30 | 15.2 |
| | 1200 | 60 | F061104512010300 | 5418250 | 279 | 487 | 528 | 3.0 | 1.30 | 16.5 |
| | 1400 | 60 | | 5418252 | 325 | 568 | 616 | 3.5 | 1.30 | 19.4 |
| | 1600 | 60 | F061104516010300 | 5418253 | 372 | 649 | 704,703 | 4.0 | 1.30 | 21.5 |
| | 1800 | 60 | F061104518010300 | 5418254 | 418 | 730 | 792,791 | 4.5 | 1.30 | 24.5 |
| | 2000 | 60 | F061104520010300 | 5418255 | 465 | 811 | 880,879 | 5.0 | 1.30 | 26.6 |
| | 2300 | 60 | | 5418256 | 535 | 933 | 1011 | 5.8 | 1.30 | 3.4 |
| | 2600 | 60 | F061104526010300 | 5418257 | 604 | 1055 | 1143 | 6.5 | 1.30 | 34.2 |
| | 3000 | 60 | | 5418258 | 697 | 1217 | 1319 | 7.5 | 1.30 | 39.2 |
| Tyyppi 21 | | | | | | | | | | |
| | 400 | 70 | F062104504010300 | 5418442 | 125 | 218 | 236 | 2.0 | 1.30 | 9.3 |
| | 500 | 70 | F062104505010300 | 5418443 | 157 | 273 | 296 | 2.5 | 1.30 | 11.3 |
| | 600 | 70 | F062104506010300 | 5418444 | 188 | 327 | 355 | 3.0 | 1.30 | 13.4 |
| | 700 | 70 | | 5418445 | 219 | 382 | 414 | 3.5 | 1.30 | 15.4 |
| | 800 | 70 | | 5418446 | 250 | 436 | 473 | 4.0 | 1.30 | 17.4 |
| | 900 | 70 | | 5418447 | 282 | 491 | 532 | 4.5 | 1.30 | 19.4 |
| | 1000 | 70 | | 5418448 | 313 | 545 | 591 | 5.0 | 1.30 | 21.4 |



450

| KORKEUS 450 mm | PITUUS | SYVYYS | Tuotenro/ LVI (VASEN) | Tuotenro/ LVI (OIKEA) | TEHO (W) 45/35/20°C | TEHO (W) 55/45/20°C | TEHO (W) 60/45/20°C | TILAVUUS (l) | N- eksponentti | PAINO (kg) |
|-------------------|--------|--------|--------------------------|-----------------------------|------------------------|------------------------|------------------------|-----------------|-------------------|---------------|
| | 1100 | 70 | F062104511010300 | 5418449 | 344 | 600 | 650 | 5.5 | 1.30 | 23.5 |
| | 1200 | 70 | 5418450 | | 376 | 654 | 709 | 6.0 | 1.30 | 25.5 |
| | 1400 | 70 | 5418452 | | 438 | 764 | 828 | 7.0 | 1.30 | 29.5 |
| | 1600 | 70 | 5418453 | | 501 | 873 | 946 | 8.0 | 1.30 | 33.6 |
| | 1800 | 70 | F062104518010300 | 5418454 | 564,563 | 982 | 1064 | 9.0 | 1.30 | 37.7 |
| | 2000 | 70 | 5418455 | | 626 | 1091 | 1182 | 10.0 | 1.30 | 41.6 |
| | 2300 | 70 | 5418456 | | 720 | 1254 | 1360 | 11.5 | 1.30 | 47.7 |
| | 2600 | 70 | 5418457 | | 814 | 1418 | 1537 | 13.0 | 1.30 | 53.8 |
| | 3000 | 70 | 5418458 | | 939 | 1636 | 1773 | 15.0 | 1.30 | 61.9 |
| Tyyppi 22 | | | | | | | | | | |
| | 400 | 102 | F062204504010300 | 5418642 | 156 | 274 | 298,297 | 2.0 | 1.32 | 1.6 |
| | 500 | 102 | 5418643 | | 195 | 343 | 372 | 2.5 | 1.32 | 13.0 |
| | 600 | 102 | 5418644 | | 234 | 411 | 446 | 3.0 | 1.32 | 15.3 |
| | 700 | 102 | 5418645 | | 273 | 480 | 521 | 3.5 | 1.32 | 17.6 |
| | 800 | 102 | 5418646 | | 312 | 548 | 595 | 4.0 | 1.32 | 19.9 |
| | 900 | 102 | 5418647 | | 351 | 617 | 669 | 4.5 | 1.32 | 22.2 |
| | 1000 | 102 | 5418648 | | 390 | 685 | 744 | 5.0 | 1.32 | 24.5 |
| | 1100 | 102 | F062204511010300 | 5418649 | 429 | 754 | 818 | 5.5 | 1.32 | 26.8 |
| | 1200 | 102 | F062204512010300 | 5418650 | 468 | 822 | 892 | 6.0 | 1.32 | 29.1 |
| | 1400 | 102 | 5418652 | | 546 | 960 | 1042 | 7.0 | 1.32 | 33.7 |
| | 1600 | 102 | F062204516010300 | 5418653 | 624,623 | 1097 | 1190 | 8.0 | 1.32 | 38.3 |
| | 1800 | 102 | F062204518010300 | 5418654 | 702 | 1234 | 1339 | 9.0 | 1.32 | 43.0 |
| | 2000 | 102 | F062204520010300 | 5418655 | 780,779 | 1371 | 1488,1487 | 10.0 | 1.32 | 47.6 |
| | 2300 | 102 | 5418656 | | 896 | 1576 | 1711 | 11.5 | 1.32 | 54.5 |
| | 2600 | 102 | 5418657 | | 1013 | 1782 | 1934 | 13.0 | 1.32 | 61.4 |



450

| KORKEUS 450 mm | PITUUS | SYVYYS | Tuoteno/ LVI (VASEN) | Tuoteno/ LVI (OIKEA) | TEHO (W) 45/35/20°C | TEHO (W) 55/45/20°C | TEHO (W) 60/45/20°C | TILAVUUS (l) | N- eksponentti | PAINO (kg) |
|-------------------|--------|--------|-------------------------|----------------------------|------------------------|------------------------|------------------------|-----------------|-------------------|---------------|
| | 3000 | 102 | F062204530010300 | 5418658 | 1169 | 2056 | 2232,2231 | 15.0 | 1.32 | 7.6 |
| Tyyppi 33 | | | | | | | | | | |
| | 400 | 152 | | 5418842 | 215 | 379 | 411 | 3.0 | 1.33 | 15.8 |
| | 500 | 152 | | 5418843 | 268 | 473 | 514 | 3.8 | 1.33 | 19.2 |
| | 600 | 152 | F063304506010300 | 5418844 | 322 | 568 | 617 | 4.5 | 1.33 | 22.7 |
| | 700 | 152 | | 5418845 | 375 | 663 | 719 | 5.3 | 1.33 | 26.1 |
| | 800 | 152 | F063304508010300 | 5418846 | 429 | 757 | 822 | 6.0 | 1.33 | 29.6 |
| | 900 | 152 | | 5418847 | 483 | 852 | 925 | 6.8 | 1.33 | 33.7 |
| | 1000 | 152 | | 5418848 | 536 | 947 | 1028 | 7.5 | 1.33 | 36.5 |
| | 1100 | 152 | F063304511010300 | 5418849 | 590 | 1041 | 1131 | 8.3 | 1.33 | 39.9 |
| | 1200 | 152 | | 5418850 | 644 | 1136 | 1234 | 9.0 | 1.33 | 43.3 |
| | 1400 | 152 | F063304514010300 | 5418852 | 751 | 1326 | 1440,1439 | 10.5 | 1.33 | 5.2 |
| | 1600 | 152 | F063304516010300 | 5418853 | 858 | 1515 | 1645 | 12.0 | 1.33 | 57.1 |
| | 1800 | 152 | | 5418854 | 965 | 1704 | 1850 | 13.5 | 1.33 | 64.1 |
| | 2000 | 152 | | 5418855 | 1073 | 1894 | 2056 | 15.0 | 1.33 | 7.9 |
| | 2300 | 152 | | 5418856 | 1234 | 2178 | 2365 | 17.3 | 1.33 | 81.2 |
| | 2600 | 152 | | 5418857 | 1394 | 2462 | 2673 | 19.5 | 1.33 | 91.6 |
| | 3000 | 152 | | 5418858 | 1609 | 2840 | 3084 | 22.5 | 1.33 | 107.4 |



500

| KORKEUS 500 mm | PITUUS | SYVYYS | Tuoteno/ LVI (VASEN) | Tuoteno/ LVI (OIKEA) | TEHO (W) 45/35/20°C | TEHO (W) 55/45/20°C | TEHO (W) 60/45/20°C | TILAVUUS (l) | N- eksponentti | PAINO (kg) |
|-------------------|--------|--------|-------------------------|----------------------------|------------------------|------------------------|------------------------|-----------------|-------------------|---------------|
| Tyyppi 11 | | | | | | | | | | |
| | 400 | 60 | F061105004010300 | 5418262 | 102 | 178 | 193 | 1.1 | 1.31 | 6.5 |
| | 500 | 60 | | 5418263 | 127 | 223 | 241 | 1.4 | 1.31 | 7.8 |
| | 600 | 60 | | 5418264 | 153 | 267 | 290 | 1.6 | 1.31 | 9.2 |
| | 700 | 60 | | 5418265 | 178 | 312 | 338 | 1.9 | 1.31 | 1.6 |
| | 800 | 60 | F061105008010300 | 5418266 | 204 | 356 | 386 | 2.2 | 1.31 | 12.0 |
| | 900 | 60 | F061105009010300 | 5418267 | 229 | 401 | 434 | 2.4 | 1.31 | 13.3 |
| | 1000 | 60 | F061105010010300 | 5418268 | 255 | 445 | 483 | 2.7 | 1.31 | 14.8 |
| | 1100 | 60 | F061105011010300 | 5418269 | 280 | 490 | 531 | 3.0 | 1.31 | 16.4 |
| | 1200 | 60 | | 5418270 | 306 | 534 | 579 | 3.2 | 1.31 | 17.5 |
| | 1400 | 60 | F061105014010300 | 5418272 | 357 | 623 | 676 | 3.8 | 1.31 | 2.2 |
| | 1600 | 60 | | 5418273 | 408 | 712 | 772 | 4.3 | 1.31 | 22.9 |
| | 1800 | 60 | F061105018010300 | 5418274 | 459 | 801 | 869 | 4.9 | 1.31 | 25.7 |
| | 2000 | 60 | F061105020010300 | 5418275 | 510 | 890 | 965 | 5.4 | 1.31 | 28.4 |
| | 2300 | 60 | F061105023010300 | 5418276 | 586 | 1024 | 1110 | 6.2 | 1.31 | 32.6 |
| | 2600 | 60 | F061105026010300 | 5418277 | 663 | 1158 | 1255 | 7.0 | 1.31 | 36.7 |
| | 3000 | 60 | | 5418278 | 764 | 1336 | 1448 | 8.1 | 1.31 | 43.0 |
| Tyyppi 21 | | | | | | | | | | |
| | 400 | 70 | | 5418462 | 136 | 237 | 257 | 2.2 | 1.31 | 9.6 |
| | 500 | 70 | F062105005010300 | 5418463 | 170 | 296 | 321 | 2.8 | 1.31 | 11.7 |
| | 600 | 70 | | 5418464 | 204 | 356 | 386 | 3.3 | 1.31 | 13.8 |
| | 700 | 70 | F062105007010300 | 5418465 | 237 | 415 | 450 | 3.9 | 1.31 | 15.9 |
| | 800 | 70 | | 5418466 | 271 | 474 | 514 | 4.4 | 1.31 | 18.1 |
| | 900 | 70 | | 5418467 | 305 | 533 | 578 | 5.0 | 1.31 | 2.1 |
| | 1000 | 70 | F062105010010300 | 5418468 | 339 | 593 | 643 | 5.5 | 1.31 | 22.2 |



500

| KORKEUS 500 mm | PITUUS | SYVYYS | Tuoteno/ LVI (VASEN) | Tuoteno/ LVI (OIKEA) | TEHO (W) 45/35/20°C | TEHO (W) 55/45/20°C | TEHO (W) 60/45/20°C | TILAVUUS (l) | N- eksponentti | PAINO (kg) |
|-------------------|--------|--------|-------------------------|----------------------------|------------------------|------------------------|------------------------|-----------------|-------------------|---------------|
| | 1100 | 70 | F062105011010300 | 5418469 | 373 | 652 | 707 | 6.0 | 1.31 | 24.3 |
| | 1200 | 70 | | 5418470 | 407 | 711 | 771 | 6.6 | 1.31 | 26.4 |
| | 1400 | 70 | F062105014010300 | 5418472 | 475 | 830 | 900 | 7.7 | 1.31 | 3.5 |
| | 1600 | 70 | F062105016010300 | 5418473 | 543 | 948 | 1029,1028 | 8.8 | 1.31 | 34.7 |
| | 1800 | 70 | F062105018010300 | 5418474 | 611 | 1067 | 1157 | 9.9 | 1.31 | 38.9 |
| | 2000 | 70 | F062105020010300 | 5418475 | 679,678 | 1185 | 1285 | 11.0 | 1.31 | 43.9 |
| | 2300 | 70 | F062105023010300 | 5418476 | 780 | 1363 | 1478 | 12.7 | 1.31 | 49.4 |
| | 2600 | 70 | F062105026010300 | 5418477 | 882 | 1541 | 1671 | 14.3 | 1.31 | 55.6 |
| | 3000 | 70 | | 5418478 | 1018 | 1778 | 1928 | 16.5 | 1.31 | 64.0 |
| Tyyppi 22 | | | | | | | | | | |
| | 400 | 102 | | 5418662 | 169 | 299 | 324 | 2.2 | 1.33 | 11.2 |
| | 500 | 102 | F062205005010300 | 5418663 | 212 | 373 | 405 | 2.8 | 1.33 | 13.7 |
| | 600 | 102 | | 5418664 | 254 | 448 | 486 | 3.3 | 1.33 | 16.4 |
| | 700 | 102 | F062205007010300 | 5418665 | 297,296 | 522 | 567 | 3.9 | 1.33 | 18.6 |
| | 800 | 102 | | 5418666 | 339 | 597 | 648 | 4.4 | 1.33 | 2.9 |
| | 900 | 102 | F062205009010300 | 5418667 | 381 | 672 | 729 | 5.0 | 1.33 | 23.4 |
| | 1000 | 102 | | 5418668 | 424 | 746 | 810 | 5.5 | 1.33 | 25.8 |
| | 1100 | 102 | F062205011010300 | 5418669 | 466 | 821 | 891 | 6.0 | 1.33 | 28.3 |
| | 1200 | 102 | | 5418670 | 508 | 896 | 972 | 6.6 | 1.33 | 3.6 |
| | 1400 | 102 | F062205014010300 | 5418672 | 593 | 1045 | 1134 | 7.7 | 1.33 | 35.5 |
| | 1600 | 102 | | 5418673 | 678 | 1194 | 1296 | 8.8 | 1.33 | 4.3 |
| | 1800 | 102 | | 5418674 | 762 | 1343 | 1458 | 9.9 | 1.33 | 45.2 |
| | 2000 | 102 | F062205020010300 | 5418675 | 847 | 1493 | 1620 | 11.0 | 1.33 | 5.1 |
| | 2300 | 102 | | 5418676 | 974 | 1717 | 1863 | 12.7 | 1.33 | 57.3 |
| | 2600 | 102 | F062205026010300 | 5418677 | 1102,1101 | 1940 | 2106 | 14.3 | 1.33 | 64.6 |



500

| KORKEUS 500 mm | PITUUS | SYVYYS | Tuotenumero/ LVI (VASEN) | Tuotenumero/ LVI (OIKEA) | TEHO (W) 45/35/20°C | TEHO (W) 55/45/20°C | TEHO (W) 60/45/20°C | TILAVUUS (l) | N- eksponentti | PAINO (kg) |
|-------------------|--------|--------|-----------------------------|--------------------------------|------------------------|------------------------|------------------------|-----------------|-------------------|---------------|
| | 3000 | 102 | F062205030010300 | 5418678 | 1271 | 2239 | 2431,2430 | 16.5 | 1.33 | 74.3 |
| Tyyppi 33 | | | | | | | | | | |
| | 400 | 152 | F063305004010300 | 5418862 | 232 | 411 | 447 | 3.3 | 1.34 | 16.6 |
| | 500 | 152 | F063305005010300 | 5418863 | 291,290 | 514 | 559,558 | 4.1 | 1.34 | 2.2 |
| | 600 | 152 | | 5418864 | 348 | 617 | 670 | 4.9 | 1.34 | 23.9 |
| | 700 | 152 | | 5418865 | 407 | 719 | 782 | 5.7 | 1.34 | 27.6 |
| | 800 | 152 | | 5418866 | 465 | 822 | 893 | 6.6 | 1.34 | 31.1 |
| | 900 | 152 | F063305009010300 | 5418867 | 523 | 925 | 1005 | 7.4 | 1.34 | 34.8 |
| | 1000 | 152 | F063305010010300 | 5418868 | 581 | 1028 | 1116 | 8.2 | 1.34 | 38.5 |
| | 1100 | 152 | F063305011010300 | 5418869 | 639 | 1131 | 1228 | 9.0 | 1.34 | 42.4 |
| | 1200 | 152 | F063305012010300 | 5418870 | 697 | 1233 | 1340 | 9.8 | 1.34 | 45.7 |
| | 1400 | 152 | | 5418872 | 813 | 1439 | 1563 | 11.5 | 1.34 | 52.9 |
| | 1600 | 152 | F063305016010300 | 5418873 | 930,929 | 1645 | 1786 | 13.1 | 1.34 | 6.2 |
| | 1800 | 152 | | 5418874 | 1045 | 1850 | 2010 | 14.8 | 1.34 | 67.5 |
| | 2000 | 152 | | 5418875 | 1162 | 2056 | 2233 | 16.4 | 1.34 | 74.7 |
| | 2300 | 152 | | 5418876 | 1336 | 2364 | 2568 | 18.9 | 1.34 | 85.6 |
| | 2600 | 152 | | 5418877 | 1510 | 2672 | 2903 | 21.3 | 1.34 | 96.6 |
| | 3000 | 152 | | 5418878 | 1742 | 3084 | 3349 | 24.6 | 1.34 | 111.9 |



600

| KORKEUS 600 mm | PITUUS | SYVYYS | Tuotenro/ LVI (VASEN) | Tuotenro/ LVI (OIKEA) | TEHO (W) 45/35/20°C | TEHO (W) 55/45/20°C | TEHO (W) 60/45/20°C | TILAVUUS (l) | N- eksponentti | PAINO (kg) |
|-------------------|--------|--------|--------------------------|-----------------------------|------------------------|------------------------|------------------------|-----------------|-------------------|---------------|
| Tyyppi 11 | | | | | | | | | | |
| | 400 | 60 | | 5418282 | 119 | 208 | 226 | 1.3 | 1.31 | 7.9 |
| | 500 | 60 | F061106005010300 | 5418283 | 149 | 260 | 282 | 1.6 | 1.31 | 9.5 |
| | 600 | 60 | F061106006010300 | 5418284 | 179 | 313 | 339 | 1.9 | 1.31 | 11.1 |
| | 700 | 60 | | 5418285 | 208 | 365 | 396 | 2.2 | 1.31 | 12.7 |
| | 800 | 60 | F061106008010300 | 5418286 | 238 | 417 | 452 | 2.6 | 1.31 | 14.4 |
| | 900 | 60 | F061106009010300 | 5418287 | 268 | 469 | 508 | 2.9 | 1.31 | 16.0 |
| | 1000 | 60 | F061106010010300 | 5418288 | 298 | 521 | 565 | 3.2 | 1.31 | 17.6 |
| | 1100 | 60 | F061106011010300 | 5418289 | 327 | 573 | 622,621 | 3.5 | 1.31 | 19.2 |
| | 1200 | 60 | | 5418290 | 357 | 625 | 678 | 3.8 | 1.31 | 2.9 |
| | 1400 | 60 | | 5418292 | 417 | 729 | 791 | 4.5 | 1.31 | 24.4 |
| | 1600 | 60 | F061106016010300 | 5418293 | 476 | 834 | 904 | 5.1 | 1.31 | 27.3 |
| | 1800 | 60 | | 5418294 | 536 | 938 | 1017 | 5.8 | 1.31 | 3.5 |
| | 2000 | 60 | | 5418295 | 595 | 1042 | 1130 | 6.4 | 1.31 | 33.7 |
| | 2300 | 60 | | 5418296 | 684 | 1198 | 1299 | 7.4 | 1.31 | 38.6 |
| | 2600 | 60 | F061106026010300 | 5418297 | 774 | 1354 | 1469 | 8.3 | 1.31 | 43.4 |
| | 3000 | 60 | | 5418298 | 893 | 1563 | 1695 | 9.6 | 1.31 | 49.8 |
| Tyyppi 21 | | | | | | | | | | |
| | 400 | 70 | F062106004010300 | 5418482 | 155 | 273 | 296 | 2.6 | 1.32 | 11.5 |
| | 500 | 70 | | 5418483 | 194 | 341 | 370 | 3.3 | 1.32 | 14.4 |
| | 600 | 70 | | 5418484 | 233 | 409 | 444 | 4.0 | 1.32 | 16.6 |
| | 700 | 70 | | 5418485 | 272 | 478 | 518 | 4.6 | 1.32 | 19.2 |
| | 800 | 70 | F062106008010300 | 5418486 | 311 | 546 | 592 | 5.3 | 1.32 | 21.7 |
| | 900 | 70 | | 5418487 | 349 | 614 | 666 | 5.9 | 1.32 | 24.3 |
| | 1000 | 70 | F062106010010300 | 5418488 | 388 | 682 | 740 | 6.6 | 1.32 | 26.8 |



600

| KORKEUS 600 mm | PITUUS | SYVYYS | Tuoteno/ LVI (VASEN) | Tuoteno/ LVI (OIKEA) | TEHO (W) 45/35/20°C | TEHO (W) 55/45/20°C | TEHO (W) 60/45/20°C | TILAVUUS (l) | N- eksponentti | PAINO (kg) |
|-------------------|--------|--------|-------------------------|----------------------------|------------------------|------------------------|------------------------|-----------------|-------------------|---------------|
| | 1100 | 70 | | 5418489 | 427 | 751 | 814 | 7.3 | 1.32 | 29.4 |
| | 1200 | 70 | F062106012010300 | 5418490 | 466 | 819 | 889,888 | 7.9 | 1.32 | 31.9 |
| | 1400 | 70 | F062106014010300 | 5418492 | 544,543 | 955 | 1037,1036 | 9.2 | 1.32 | 37.3 |
| | 1600 | 70 | | 5418493 | 621 | 1092 | 1185 | 10.6 | 1.32 | 42.1 |
| | 1800 | 70 | F062106018010300 | 5418494 | 699 | 1228 | 1333,1332 | 11.9 | 1.32 | 47.2 |
| | 2000 | 70 | | 5418495 | 776 | 1365 | 1481 | 13.2 | 1.32 | 52.3 |
| | 2300 | 70 | | 5418496 | 893 | 1569 | 1703 | 15.2 | 1.32 | 60.0 |
| | 2600 | 70 | | 5418497 | 1009 | 1774 | 1925 | 17.2 | 1.32 | 67.6 |
| | 3000 | 70 | F062106030010300 | 5418498 | 1165,1164 | 2047 | 2221 | 19.8 | 1.32 | 77.8 |
| Tyyppi 22 | | | | | | | | | | |
| | 400 | 102 | F062206004010300 | 5418682 | 195 | 346 | 375 | 2.6 | 1.34 | 13.8 |
| | 500 | 102 | | 5418683 | 244 | 432 | 469 | 3.3 | 1.34 | 16.8 |
| | 600 | 102 | | 5418684 | 293 | 518 | 563 | 4.0 | 1.34 | 19.6 |
| | 700 | 102 | F062206007010300 | 5418685 | 342 | 605 | 657 | 4.6 | 1.34 | 22.6 |
| | 800 | 102 | F062206008010300 | 5418686 | 391 | 691 | 750 | 5.3 | 1.34 | 25.5 |
| | 900 | 102 | | 5418687 | 440 | 777 | 844 | 5.9 | 1.34 | 28.4 |
| | 1000 | 102 | F062206010010300 | 5418688 | 488 | 864 | 938 | 6.6 | 1.34 | 31.4 |
| | 1100 | 102 | F062206011010300 | 5418689 | 537 | 950 | 1032 | 7.3 | 1.34 | 34.3 |
| | 1200 | 102 | | 5418690 | 586 | 1037 | 1126 | 7.9 | 1.34 | 37.2 |
| | 1400 | 102 | F062206014010300 | 5418692 | 684 | 1209 | 1314,1313 | 9.2 | 1.34 | 43.9 |
| | 1600 | 102 | | 5418693 | 781 | 1382 | 1501 | 10.6 | 1.34 | 49.0 |
| | 1800 | 102 | | 5418694 | 879 | 1555 | 1689 | 11.9 | 1.34 | 54.9 |
| | 2000 | 102 | F062206020010300 | 5418695 | 977 | 1728 | 1876 | 13.2 | 1.34 | 6.7 |
| | 2300 | 102 | | 5418696 | 1123 | 1987 | 2158 | 15.2 | 1.34 | 69.5 |
| | 2600 | 102 | F062206026010300 | 5418697 | 1270 | 2246 | 2439 | 17.2 | 1.34 | 78.3 |



600

| KORKEUS 600 mm | PITUUS | SYVYYS | Tuotenumero/ LVI (VASEN) | Tuotenumero/ LVI (OIKEA) | TEHO (W) 45/35/20°C | TEHO (W) 55/45/20°C | TEHO (W) 60/45/20°C | TILAVUUS (l) | N- eksponentti | PAINO (kg) |
|-------------------|--------|--------|-----------------------------|--------------------------------|------------------------|------------------------|------------------------|-----------------|-------------------|---------------|
| | 3000 | 102 | | 5418698 | 1465 | 2591 | 2815 | 19.8 | 1.34 | 90.0 |
| Tyyppi 33 | | | | | | | | | | |
| | 400 | 152 | | 5418882 | 266 | 473 | 514 | 3.9 | 1.35 | 2.8 |
| | 500 | 152 | F063306005010300 | 5418883 | 333 | 592 | 643 | 4.9 | 1.35 | 24.5 |
| | 600 | 152 | F063306006010300 | 5418884 | 399 | 710 | 772,771 | 5.9 | 1.35 | 28.9 |
| | 700 | 152 | | 5418885 | 466 | 828 | 900 | 6.9 | 1.35 | 33.3 |
| | 800 | 152 | | 5418886 | 532 | 946 | 1029 | 7.8 | 1.35 | 37.6 |
| | 900 | 152 | F063306009010300 | 5418887 | 599 | 1065 | 1157 | 8.8 | 1.35 | 42.2 |
| | 1000 | 152 | F063306010010300 | 5418888 | 665 | 1183 | 1286 | 9.8 | 1.35 | 46.4 |
| | 1100 | 152 | F063306011010300 | 5418889 | 732 | 1301 | 1415,1414 | 10.8 | 1.35 | 5.9 |
| | 1200 | 152 | | 5418890 | 798 | 1420 | 1543 | 11.8 | 1.35 | 55.2 |
| | 1400 | 152 | F063306014010300 | 5418892 | 932,931 | 1656 | 1800 | 13.7 | 1.35 | 64.0 |
| | 1600 | 152 | F063306016010300 | 5418893 | 1065,1064 | 1893 | 2058,2057 | 15.7 | 1.35 | 72.8 |
| | 1800 | 152 | | 5418894 | 1197 | 2129 | 2315 | 17.6 | 1.35 | 81.5 |
| | 2000 | 152 | | 5418895 | 1330 | 2366 | 2572 | 19.6 | 1.35 | 9.4 |
| | 2300 | 152 | | 5418896 | 1530 | 2721 | 2958 | 22.5 | 1.35 | 105.5 |
| | 2600 | 152 | F063306026010300 | 5418897 | 1730 | 3076 | 3344,3343 | 25.5 | 1.35 | 116.7 |
| | 3000 | 152 | | 5418898 | 1996 | 3549 | 3858 | 29.4 | 1.35 | 134.3 |



900

| KORKEUS 900 mm | PITUUS | SYVYYS | Tuoteno/ LVI (VASEN) | Tuoteno/ LVI (OIKEA) | TEHO (W) 45/35/20°C | TEHO (W) 55/45/20°C | TEHO (W) 60/45/20°C | TILAVUUS (l) | N- eksponentti | PAINO (kg) |
|-------------------|--------|--------|-------------------------|----------------------------|------------------------|------------------------|------------------------|-----------------|-------------------|---------------|
| Tyyppi 11 | | | | | | | | | | |
| | 400 | 60 | F061109004010300 | 5418302 | 166 | 291 | 316 | 1.8 | 1.32 | 11.9 |
| | 500 | 60 | | 5418303 | 208 | 364 | 395 | 2.3 | 1.32 | 14.3 |
| | 600 | 60 | | 5418304 | 249 | 437 | 474 | 2.7 | 1.32 | 16.8 |
| | 700 | 60 | F061109007010300 | 5418305 | 291 | 510 | 553 | 3.1 | 1.32 | 19.2 |
| | 800 | 60 | F061109008010300 | 5418306 | 332 | 583 | 632 | 3.6 | 1.32 | 21.7 |
| | 900 | 60 | | 5418307 | 373 | 655 | 711 | 4.0 | 1.32 | 24.2 |
| | 1000 | 60 | F061109010010300 | 5418308 | 415 | 728 | 790 | 4.5 | 1.32 | 26.7 |
| | 1100 | 60 | F061109011010300 | 5418309 | 457 | 801 | 869 | 5.0 | 1.32 | 29.2 |
| | 1200 | 60 | F061109012010300 | 5418310 | 498 | 874 | 948 | 5.4 | 1.32 | 31.6 |
| | 1400 | 60 | F061109014010300 | 5418312 | 581 | 1019 | 1106 | 6.3 | 1.32 | 36.6 |
| | 1600 | 60 | F061109016010300 | 5418313 | 664 | 1165 | 1264 | 7.2 | 1.32 | 41.6 |
| | 1800 | 60 | | 5418314 | 747 | 1311 | 1422 | 8.1 | 1.32 | 46.5 |
| | 2000 | 60 | | 5418315 | 830 | 1456 | 1580 | 9.0 | 1.32 | 51.5 |
| | 2300 | 60 | F061109023010300 | 5418316 | 955 | 1675 | 1817 | 10.3 | 1.32 | 58.9 |
| | 2600 | 60 | | 5418317 | 1079 | 1893 | 2054 | 11.7 | 1.32 | 66.4 |
| | 3000 | 60 | | 5418318 | 1245 | 2185 | 2370 | 13.5 | 1.32 | 76.3 |
| Tyyppi 21 | | | | | | | | | | |
| | 400 | 70 | F062109004010300 | 5418502 | 212 | 376 | 408 | 3.6 | 1.34 | 16.7 |
| | 500 | 70 | F062109005010300 | 5418503 | 265 | 470 | 510 | 4.5 | 1.34 | 2.6 |
| | 600 | 70 | | 5418504 | 318 | 563 | 612 | 5.4 | 1.34 | 24.3 |
| | 700 | 70 | | 5418505 | 371 | 657 | 714 | 6.3 | 1.34 | 28.6 |
| | 800 | 70 | | 5418506 | 424 | 751 | 816 | 7.2 | 1.34 | 31.8 |
| | 900 | 70 | F062109009010300 | 5418507 | 477 | 845 | 918 | 8.1 | 1.34 | 35.6 |
| | 1000 | 70 | | 5418508 | 530 | 939 | 1020 | 9.0 | 1.34 | 39.5 |



900

| KORKEUS 900 mm | PITUUS | SYVYYS | Tuotenro/ LVI (VASEN) | Tuotenro/ LVI (OIKEA) | TEHO (W) 45/35/20°C | TEHO (W) 55/45/20°C | TEHO (W) 60/45/20°C | TILAVUUS (l) | N- eksponentti | PAINO (kg) |
|-------------------|--------|--------|--------------------------|-----------------------------|------------------------|------------------------|------------------------|-----------------|-------------------|---------------|
| | 1100 | 70 | | 5418509 | 583 | 1033 | 1122 | 9.9 | 1.34 | 43.2 |
| | 1200 | 70 | F062109012010300 | 5418510 | 636 | 1127 | 1224 | 10.8 | 1.34 | 47.0 |
| | 1400 | 70 | | 5418512 | 742 | 1315 | 1428 | 12.6 | 1.34 | 54.5 |
| | 1600 | 70 | F062109016010300 | 5418513 | 849,848 | 1502 | 1632 | 14.4 | 1.34 | 62.8 |
| | 1800 | 70 | F062109018010300 | 5418514 | 955,954 | 1690 | 1836 | 16.2 | 1.34 | 69.6 |
| | 2000 | 70 | | 5418515 | 1060 | 1878 | 2040 | 18.0 | 1.34 | 77.2 |
| | 2300 | 70 | | 5418516 | 1219 | 2160 | 2346 | 20.7 | 1.34 | 88.5 |
| | 2600 | 70 | | 5418517 | 1379 | 2442 | 2653 | 23.4 | 1.34 | 101.8 |
| | 3000 | 70 | | 5418518 | 1591 | 2817 | 3060 | 27.0 | 1.34 | 115.0 |
| Tyyppi 22 | | | | | | | | | | |
| | 400 | 102 | F062209004010300 | 5418702 | 268 | 478 | 520 | 3.6 | 1.36 | 19.8 |
| | 500 | 102 | F062209005010300 | 5418703 | 335 | 597 | 650,649 | 4.5 | 1.36 | 24.2 |
| | 600 | 102 | | 5418704 | 402 | 717 | 780 | 5.4 | 1.36 | 28.7 |
| | 700 | 102 | | 5418705 | 469 | 836 | 910 | 6.3 | 1.36 | 33.2 |
| | 800 | 102 | F062209008010300 | 5418706 | 536 | 956 | 1039 | 7.2 | 1.36 | 37.7 |
| | 900 | 102 | F062209009010300 | 5418707 | 603 | 1075 | 1169 | 8.1 | 1.36 | 42.2 |
| | 1000 | 102 | | 5418708 | 670 | 1194 | 1299 | 9.0 | 1.36 | 46.7 |
| | 1100 | 102 | F062209011010300 | 5418709 | 737 | 1314 | 1429 | 9.9 | 1.36 | 51.2 |
| | 1200 | 102 | | 5418710 | 804 | 1433 | 1559 | 10.8 | 1.36 | 55.7 |
| | 1400 | 102 | | 5418712 | 937 | 1672 | 1819 | 12.6 | 1.36 | 64.7 |
| | 1600 | 102 | F062209016010300 | 5418713 | 1072,1071 | 1911 | 2079,2078 | 14.4 | 1.36 | 73.7 |
| | 1800 | 102 | | 5418714 | 1205 | 2150 | 2338 | 16.2 | 1.36 | 82.7 |
| | 2000 | 102 | | 5418715 | 1339 | 2389 | 2598 | 18.0 | 1.36 | 91.6 |
| | 2300 | 102 | | 5418716 | 1540 | 2747 | 2988 | 20.7 | 1.36 | 107.2 |
| | 2600 | 102 | F062209026010300 | 5418717 | 1741 | 3106 | 3378,3377 | 23.4 | 1.36 | 118.7 |



900

| KORKEUS 900 mm | PITUUS | SYVYYS | Tuoteno/ LVI (VASEN) | Tuoteno/ LVI (OIKEA) | TEHO (W) 45/35/20°C | TEHO (W) 55/45/20°C | TEHO (W) 60/45/20°C | TILAVUUS (l) | N- eksponentti | PAINO (kg) |
|-------------------|--------|--------|-------------------------|----------------------------|------------------------|------------------------|------------------------|-----------------|-------------------|---------------|
| | 3000 | 102 | F062209030010300 | 5418718 | 2009 | 3583 | 3897,3896 | 27.0 | 1.36 | 136.6 |
| Tyyppi 33 | | | | | | | | | | |
| | 400 | 152 | F063309004010300 | 5418902 | 364 | 651 | 708 | 5.3 | 1.36 | 28.7 |
| | 500 | 152 | | 5418903 | 455 | 814 | 885 | 6.7 | 1.36 | 35.4 |
| | 600 | 152 | F063309006010300 | 5418904 | 547,546 | 976 | 1062 | 8.0 | 1.36 | 42.9 |
| | 700 | 152 | | 5418905 | 637 | 1139 | 1239 | 9.3 | 1.36 | 48.8 |
| | 800 | 152 | F063309008010300 | 5418906 | 729 | 1302 | 1416 | 10.6 | 1.36 | 55.5 |
| | 900 | 152 | F063309009010300 | 5418907 | 820 | 1465 | 1593 | 12.0 | 1.36 | 62.3 |
| | 1000 | 152 | F063309010010300 | 5418908 | 911 | 1627 | 1770 | 13.3 | 1.36 | 69.0 |
| | 1100 | 152 | F063309011010300 | 5418909 | 1002 | 1790 | 1947 | 14.6 | 1.36 | 75.6 |
| | 1200 | 152 | F063309012010300 | 5418910 | 1093 | 1953 | 2124 | 16.0 | 1.36 | 82.3 |
| | 1400 | 152 | | 5418912 | 1275 | 2278 | 2478 | 18.6 | 1.36 | 95.7 |
| | 1600 | 152 | | 5418913 | 1457 | 2604 | 2832 | 21.3 | 1.36 | 111.3 |
| | 1800 | 152 | F063309018010300 | 5418914 | 1640,1639 | 2929 | 3187,3186 | 23.9 | 1.36 | 122.6 |
| | 2000 | 152 | F063309020010300 | 5418915 | 1822,1821 | 3255 | 3541,3540 | 26.6 | 1.36 | 136.0 |
| | 2300 | 152 | | 5418916 | 2095 | 3743 | 4072 | 30.6 | 1.36 | 156.8 |
| | 2600 | 152 | | 5418917 | 2368 | 4231 | 4603 | 34.6 | 1.36 | 176.2 |
| | 3000 | 152 | F063309030010300 | 5418918 | 2733,2732 | 4882 | 5311,5310 | 39.9 | 1.36 | 207.0 |