



Tietolehti

2026-05-06

Compact ©

Perinteinen radiaattori 4 x 1/2" liitännöillä, päälliritillä sekä sivupaneeleilla.

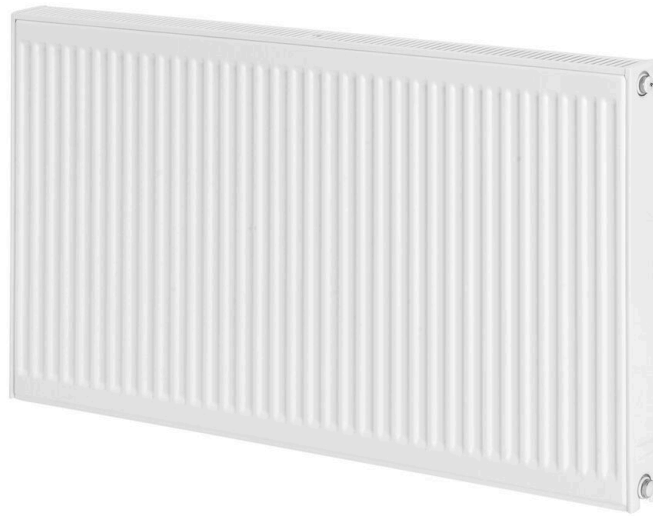

- ✓ Korkea paineenkestävyys
- ✓ Esteettinen muotoilu
- ✓ Monipuoliset asennusvaihtoehdot
- ✓ Tehokas lämmönjako
- ✓ Laaja värivalikoima

Compact on perinteinen paneeliradiaattori suljettuihin vesikiertoisiin keskilämmitysjärjestelmiin. Compact-paneeliradiaattorissa on neljä G 1/2" -liitintä sisäkierteellä, mikä mahdollistaa sivuliitännän oikealta ja vasemmalta puolelta. Korkealaatuinen radiaattori, laadukas viimeistely ja markkinoiden laajin valikoima. Compact on suunniteltu optimaaliseen lämpösäteilyyn standardin EN442-1 mukaisesti ja kaikki mallit ovat CE-merkittyjä. Compact toimitetaan asennetuilla sivupaneeleilla, yläritillä ja lapsiturvallisella kiinnityksellä. Toimitukseen sisältyvät kiinnikkeet, ritilät, sivupaneelit. Käyttöolosuhteet/-ympäristö on otettava huomioon ja asennusohjeita on noudatettava asennuksessa. Vakiona valkoinen RAL 9016 (muuta värejä saatavilla lisämaksusta). Takuu-aika on 10 vuotta, ja takuuohjeissa lisätietoa sallituista käyttöympäristöistä.



Käyttöalue

Sopii asuin- ja liikerakennuksiin, joissa tarvitaan korkeita paineasetuksia jopa 10 baaria. Ihanteellinen monikerroksisiin rakennuksiin, kaukolämpöjärjestelmiin ja suurempiin asennuksiin. Yhteensopiva järjestelmien kanssa, joiden enimmäiskäyttölämpötila on 110°C ja varustettu pystysuorilla vesikanavilla 33.3 mm välein tehokasta lämmönjakelua varten.

Mitoitus

Käytä suunnittelupalveluamme yksityiskohtaiseen valintaan tai katso esitteestämme nopeaa valintaa varten.

Käyttö

Varmista, että asennus tehdään mukana toimitetuilla MCW-7 seinäkiinnikkeillä vakauden takaamiseksi. Jäähdyttimen liitännät tehdään 4 x G 1/2" sivuaukkojen kautta. Säännöllinen huolto on tarpeen optimaalisen suorituskyvyn varmistamiseksi. Suurimmat

käyttöparametrit ovat 10 baarin työpaine ja 110°C toimintalämpötila.

Suunnittelijan teksti

Purmon Compact (33.3) -radiaattori on suunniteltu korkeapaineisiin kohteisiin, joiden suurin käyttöpaine on 10 baaria ja suurin käyttölämpötila 110 °C. Siinä on EN 10130 -standardin mukainen syvävedetty, vähähiilinen kylmävalssattu teräs. Tässä radiaattorissa on 33,3 mm:n välein pystysuorat vesikanavat, jotka jakavat lämpöä tehokkaasti, ja se on viimeistelty valmiiksi esiasennetuilla sivupaneeleilla ja yläsäleiköllä. Vakiovärinä valkoinen RAL 9016, muita väri vaihtoehtoja on saatavana pyynnöstä. Liitännät tehdään 4 x G 1/2" sivuaukkojen kautta, ja radiaattorin mukana toimitetaan seinäkiinnityskannattimet, tulpat ja tuuletusaukko. Saatavana useina eri kokoina, se palvelee sekä asuin- että kaupallisia tarpeita ja sopii saumattomasti monikerroksisiin rakennuksiin ja kaukolämpöjärjestelmiin.



Määrittelyt

OMINAISUUDET	YKSIKKÖ	ARVOT
ETIM-luokka		EC011022
Materiaali		teräs
Tyyppi		11, 21, 22, 33
Pintarakenne		profiloitu
Suurin käyttöpaine	bar	10
Vakioliitännöjen määrä		4
Lämmitysteho EN 442 -hyväksytyn laboratorion mukaan		Kyllä
Maksimi käyttölämpötila	°C	110
Vakioväri		Kyllä
Väri		valkoinen
RAL-numero		9016
Säleikkö/Peitelevy		Kyllä
Säleikkö/Peitelevy		Kyllä
Kiiltoaste		kiiltävä
Kierrekoko (tuuma)		1/2"
Liitäntä kierre		sisäkierre
Yhden pisteen liitännällä		Kyllä
Ilmausliitännällä		Kyllä
Ilmausventtiilillä/ilmaajalla		Kyllä
Tyhjennysmahdollisuudella		Kyllä



Dokumentit

DOKUMENTIT	DOKUMENTTITYYPPI	LINKKI
PURMO - radiaattorivalikoiman tekninen esite, 2018	ProductCatalog	https://asset.productmarketingcloud.com/api/assetstorage/3577_ed398445-293c-4d35-be10-ab31eca9c1cb
Värikartta 2025	Brochure	https://asset.productmarketingcloud.com/api/assetstorage/3577_190325f8-8b3b-4b3a-84d1-15ae17bd0b59
Takuehdot, Purmo radiaattorit ja konvektorit	Warranty	https://asset.productmarketingcloud.com/api/assetstorage/3577_00ce510b-77ef-40a3-9b7e-bfc12453a5a3
Asennus- ja Huolto ohje, Paneeliradiaattorit	Installation	https://asset.productmarketingcloud.com/api/assetstorage/3577_2f8590e0-d2e8-4d65-bd59-843321666e62
Tiivyskoe, ohjeet ja pöytäkirja - radiattorit ja konvektorit FI-SE	Installation	https://asset.productmarketingcloud.com/api/assetstorage/3577_c339a119-c7a0-46c2-a699-964efbdd617a
Purmo Teholaskenta, Paneeliradiaattorit (DE)	TechDia	https://asset.productmarketingcloud.com/api/assetstorage/3577_2da398bb-5820-4a58-af2d-623333aa4e65e



Resurssit



ProductImage - Purmo Compact, C, detail above.



ProductImage - Purmo Compact, C, product image 30 degrees.

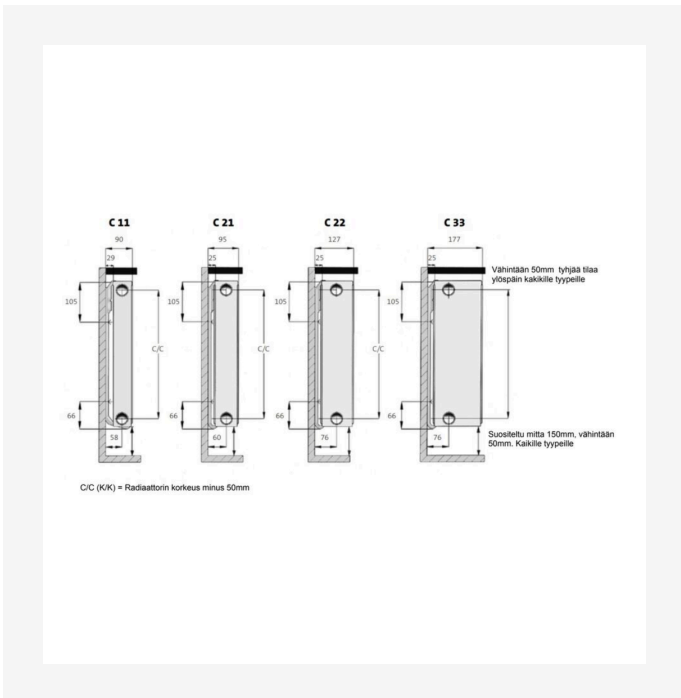

DimensionalDrawing - Radiaattorin kannakointiohje

COMPACT (mm)				
	C11		C21s, C22, C33	
A	a1	a2	a1	a2
400-1600	117	-	133	-
1800	117	917	133	900
2000	117	1017	133	1000
2300	117	1150	133	1167
2600	117	1317	133	1300
3000	117	1517	133	1500

DimensionalDrawing - Compact, taulukkopiirros A



Resurssit

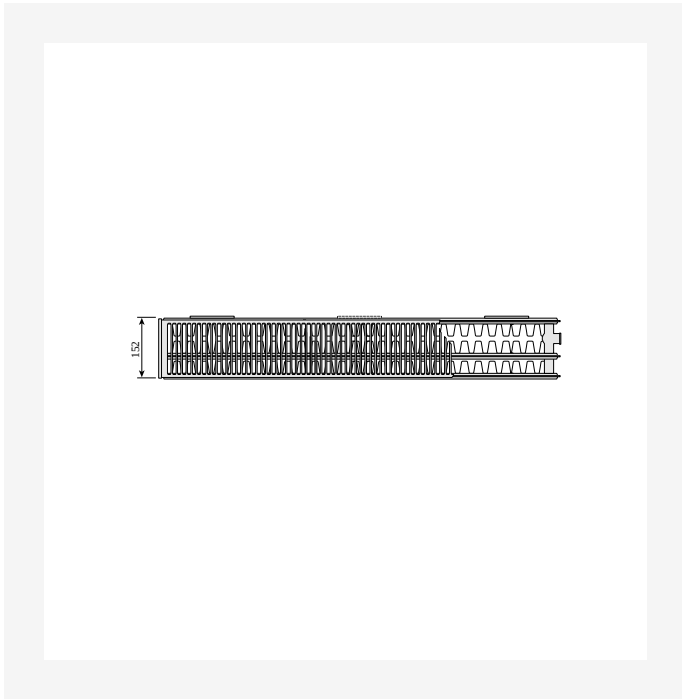

DimensionalDrawing - Compact, tyyppi 33, ylhäältäpäin

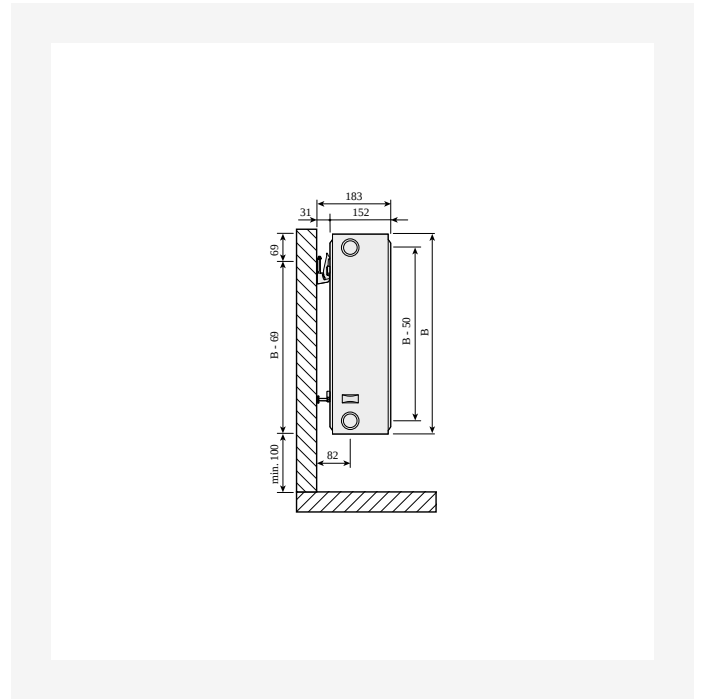

DimensionalDrawing - Compact, tyyppi 33, sivunäkymä SSMS-seinäkannakkeilla

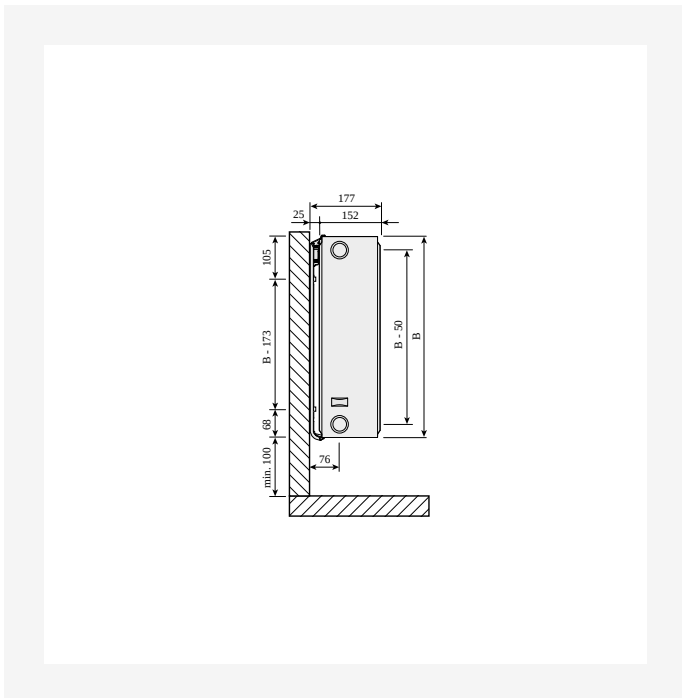

DimensionalDrawing - Compact, tyyppi 33, sivunäkymä Monclac-seinäkannakkeilla

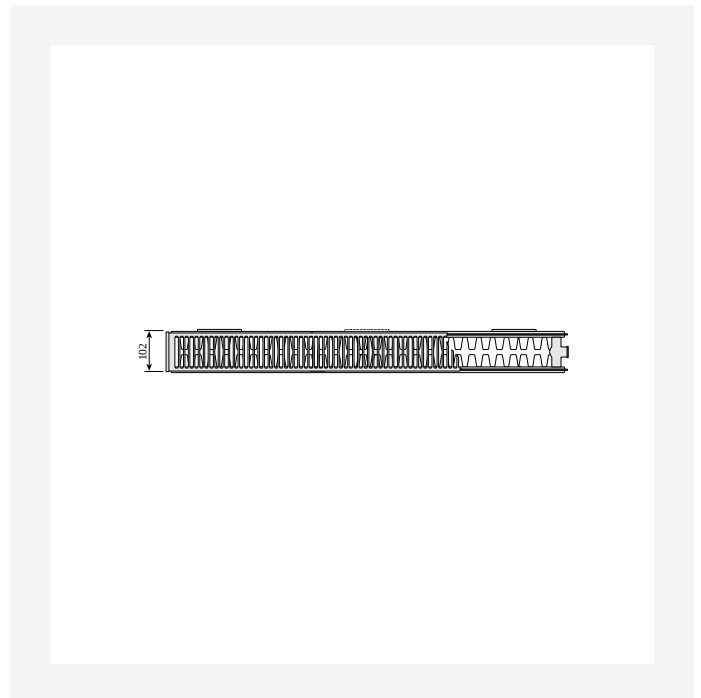

DimensionalDrawing - Compact, tyyppi 22, ylhäältäpäin



Resurssit

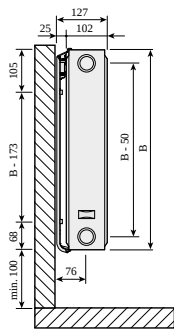

DimensionalDrawing - Compact, tyyppi 22, sivunäkymä
Monclac-seinäkannakkeilla

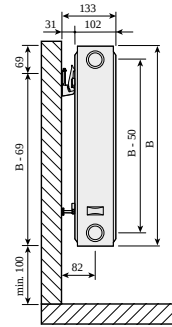

DimensionalDrawing - Compact, tyyppi 22, sivunäkymä
SSMS-seinäkannakkeilla



DimensionalDrawing - Compact, tyyppi 21, ylhäältäpäin

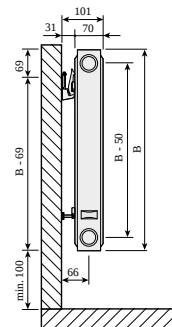

DimensionalDrawing - Compact, tyyppi 21, sivunäkymä
SSMS-seinäkannakkeilla



Resurssit

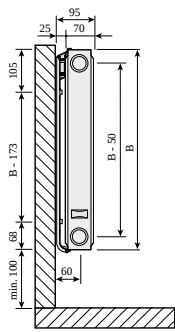

DimensionalDrawing - Compact, tyyppi 21, sivunäkymä
Monclac-seinäkannakkeilla

DimensionalDrawing - Compact, tyyppi 11, ylhäältäpäin

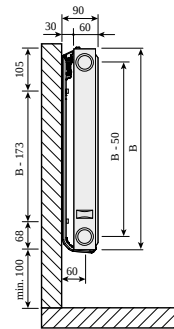
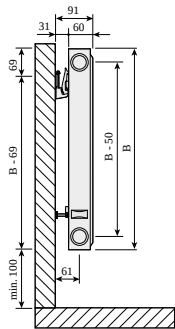

DimensionalDrawing - Compact, tyyppi 11, sivunäkymä
SSMS-seinäkannakkeilla

DimensionalDrawing - Compact, tyyppi 11, sivunäkymä
Monclac-seinäkannakkeilla



Resurssit

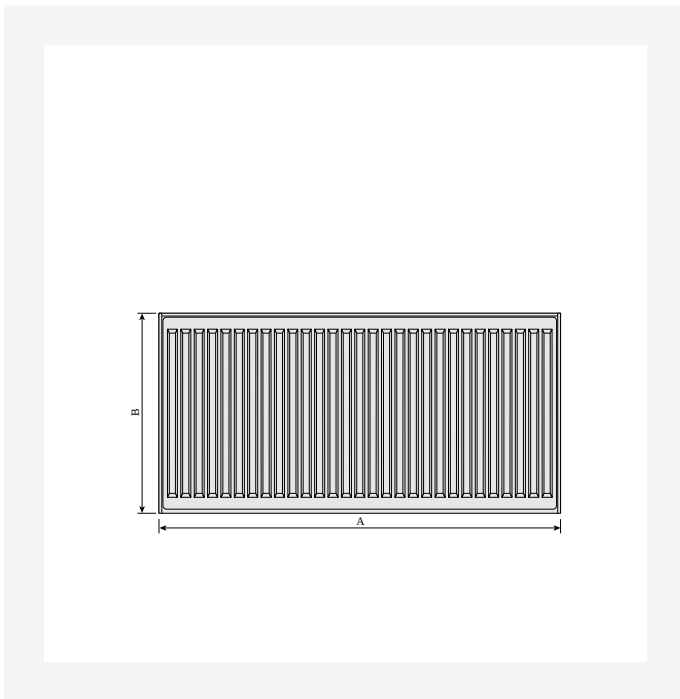

DimensionalDrawing - Compact, etunäkymä

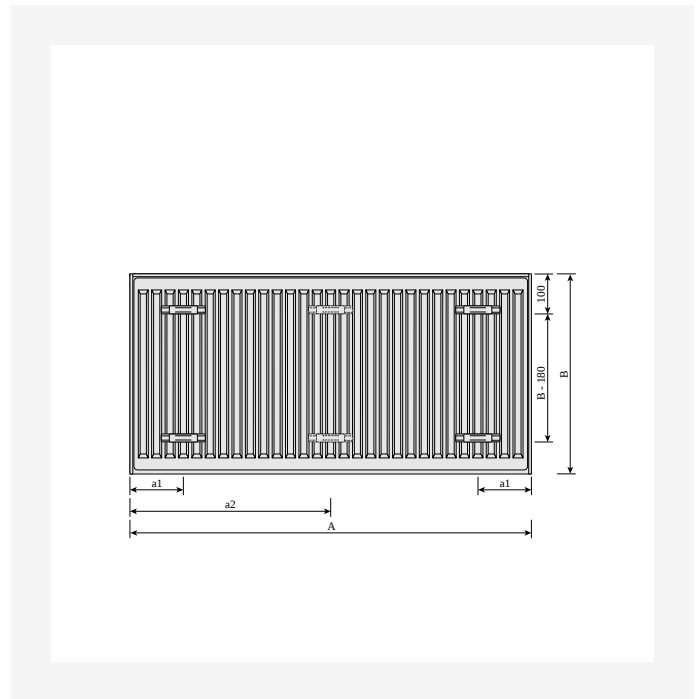

DimensionalDrawing - Compact, takaa

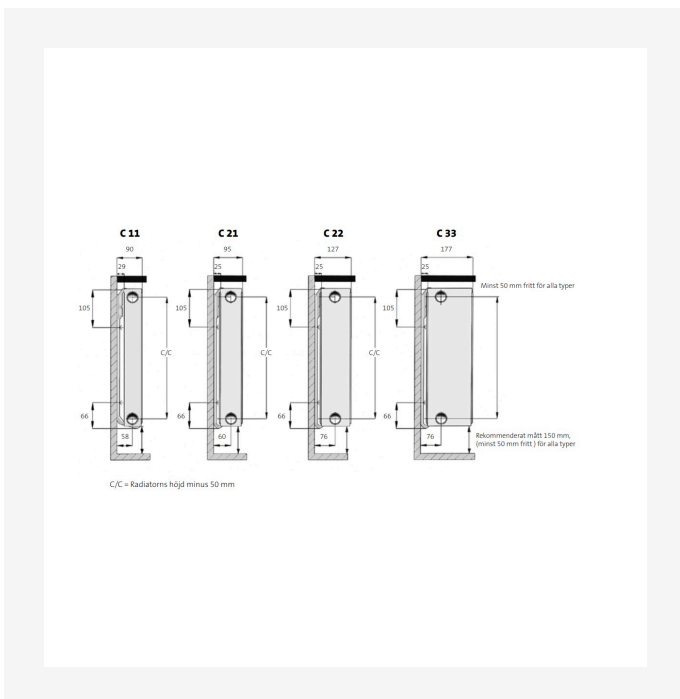

DimensionalDrawing - Asennusmitat

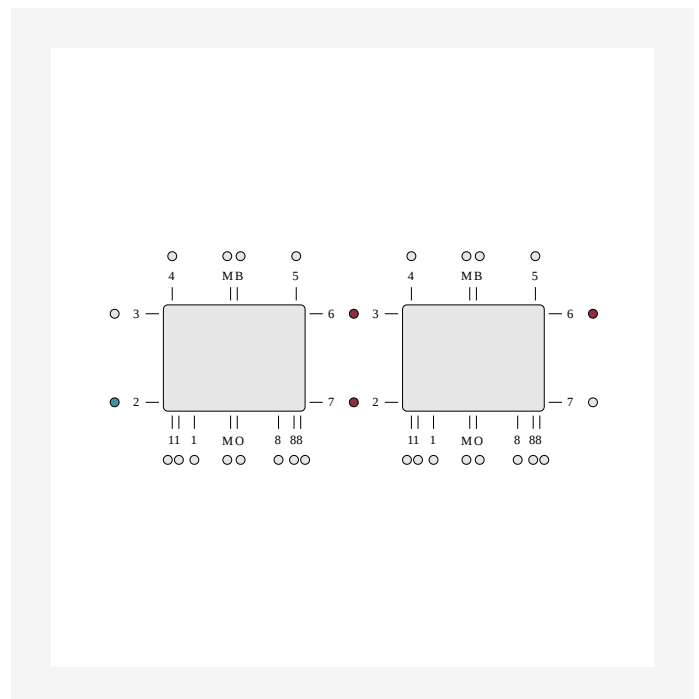

DimensionalDrawing - ETIM 62 Sarjaankytkentä vaakasuora liitäntä

Resurssit

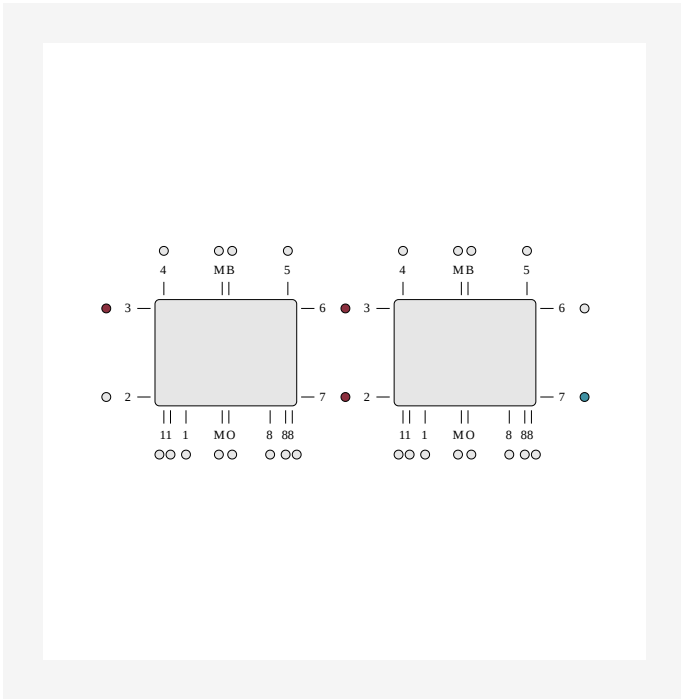

DimensionalDrawing - ETIM 37 Sarjaankytkentä vaakasuora liitäntä

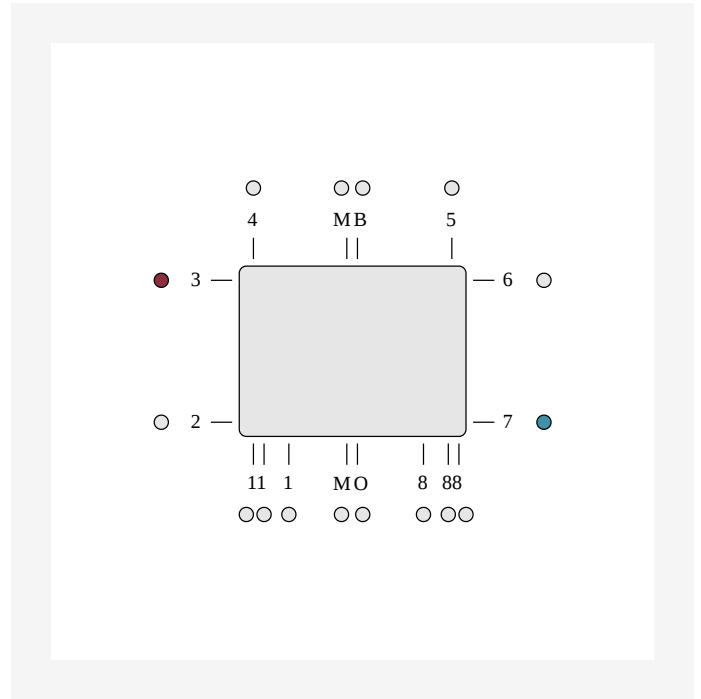

DimensionalDrawing - Diagonaaliliitäntä ETIM 37. Diagonaaliliitäntä edellyttää ulkoisen venttiilin käyttöä. Diagonaaliliitännässä alaliitännät on tulpattu.

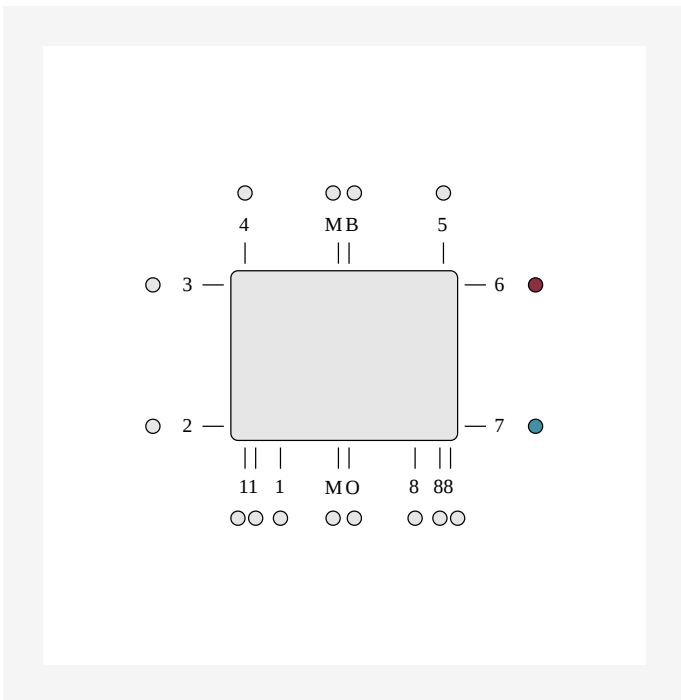

DimensionalDrawing - Sivuliitäntä ETIM 67. Sivuliitäntä edellyttää ulkoisen patteriliittimen tai venttiilin käyttöä. Sivuliitännän tapauksessa alaosien liitännät tulpataan.

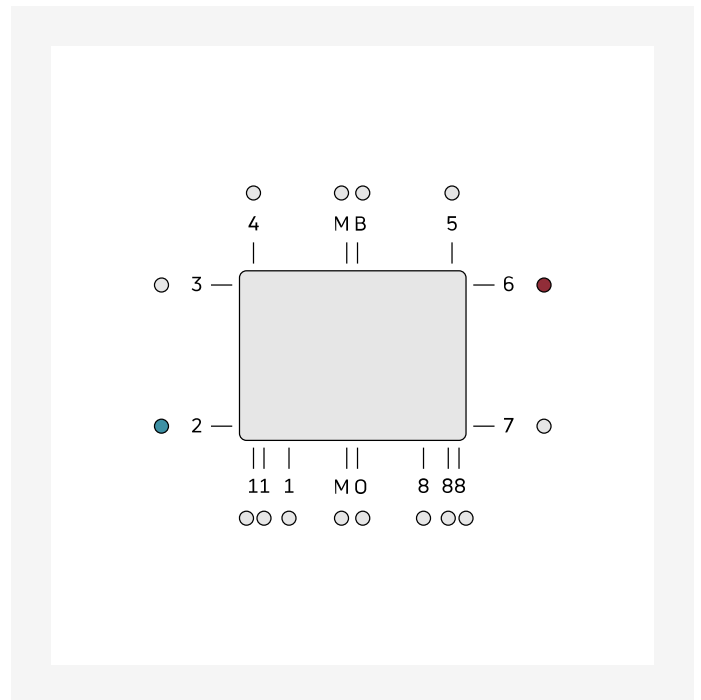

DimensionalDrawing - Diagonaaliliitäntä ETIM 62. Diagonaaliliitäntä edellyttää ulkoisen venttiilin käyttöä. Diagonaaliliitännän tapauksessa alaosien liitännät tulpataan.



Resurssit

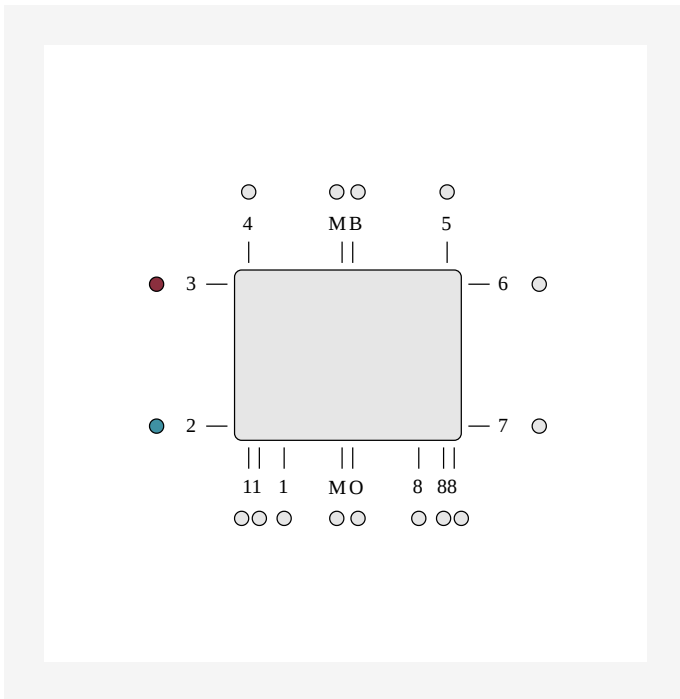

DimensionalDrawing - Sivuliitäntä ETIM 32. Sivuliitäntä edellyttää ulkoisen patteriventtiilin käyttöä. Sivuliitännän tapauksessa alaosien liitännät tulpataan.



Liittyvät tuotteet



Anturi



Päälliritilä



Air



Ilmausruuvi- ja
umpitulppasarja 1/2"



Korjausmaali Tipex



Sivupaneeli



Ilmausventtiili 1/2"



Seinäkannake Monclac MCA



Ilmausavain



Radiaattorin puhdistusharja



Flex-radiaattoriliitäntä

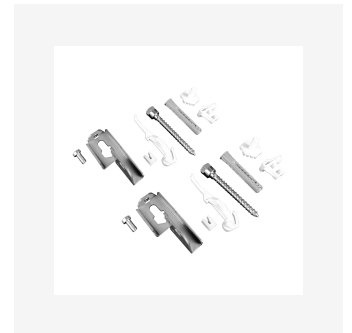

Pikakannake Quick (SSMS)



Liittyvät tuotteet



Lukitusalpa, C ja TP



Evosense-termostaattipää



Paluuventtiili RV

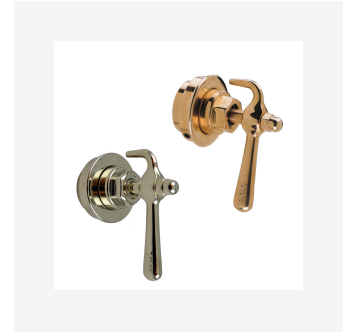

Läppäventtiili, käsipyörä



Evosense Sprint -
termostaattipää



Jalkakannakesuoja



Evoflow-radiaattoriventtiili



Evosense Public -
termostaattipää

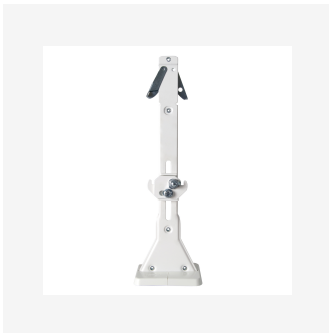

Purmo Monclac -lattiatuki

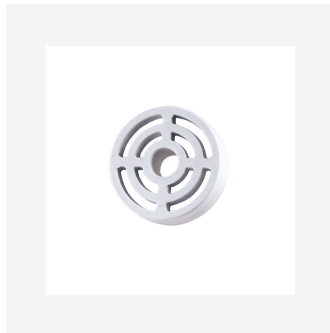

Seinäholkki



Evosense Remote -
termostaattipää



Turvakannake



300

KORKEUS 300 mm	PITUUS	SYVYYS	Tuotenro/ LVI (VASEN)	Tuotenro/ LVI (OIKEA)	TEHO (W) 45/35/20°C	TEHO (W) 55/45/20°C	TEHO (W) 60/45/20°C	TILAVUUS (l)	N- eksponentti	PAINO (kg)
Tyyppi 11										
400	60		5418202		65	113	122	0.7	1.30	4.4
500	60		5418203		81	141	152	0.8	1.30	5.1
600	60		5418204		97	169	183	1.0	1.30	5.9
700	60		F061103007010300	5418205	113	197	213	1.2	1.30	6.7
800	60		F061103008010300	5418206	129	225	244	1.4	1.30	7.5
900	60		F061103009010300	5418207	146,145	253	274	1.5	1.30	8.3
1000	60		5418208		162	281	305	1.7	1.30	9.2
1100	60		F061103011010300	5418209	178	309	336,335	1.9	1.30	10.0
1200	60		F061103012010300	5418210	194	338	366	2.0	1.30	1.6
1400	60		5418212		226	394	427	2.4	1.30	12.2
1600	60		F061103016010300	5418213	259	450	488	2.7	1.30	13.8
1800	60		5418214		291	506	549	3.1	1.30	15.4
2000	60		5418215		323	563	610	3.4	1.30	17.0
2300	60		5418216		372	647	701	3.9	1.30	19.4
2600	60		F061103026010300	5418217	420	731	793,792	4.4	1.30	21.7
3000	60		5418218		485	844	915	5.1	1.30	24.9
Tyyppi 21										
400	70		F062103004010300	5418402	92	158	171	1.4	1.28	6.2
500	70		5418403		115	198	214	1.7	1.28	7.4
600	70		5418404		138	237	257	2.0	1.28	8.6
700	70		5418405		160	277	300	2.4	1.28	10.0
800	70		5418406		183	317	343	2.7	1.28	11.3
900	70		5418407		206	356	386	3.1	1.28	12.3



300

KORKEUS 300 mm	PITUUS	SYVYYS	Tuotenro/ LVI (VASEN)	Tuotenro/ LVI (OIKEA)	TEHO (W) 45/35/20°C	TEHO (W) 55/45/20°C	TEHO (W) 60/45/20°C	TILAVUUS (l)	N- ekspONENTTI	PAINO (kg)
	1000	70		5418408	229	396	428	3.4	1.28	13.6
	1100	70	F062103011010300	5418409	252	435	471	3.7	1.28	14.8
	1200	70		5418410	275	475	514	4.1	1.28	16.4
	1400	70	F062103014010300	5418412	321	554	600,599	4.8	1.28	18.7
	1600	70		5418413	367	633	686	5.4	1.28	21.1
	1800	70	F062103018010300	5418414	412	712	771	6.1	1.28	23.6
	2000	70		5418415	458	791	857	6.8	1.28	26.1
	2300	70		5418416	527	910	985	7.8	1.28	30.0
	2600	70		5418417	596	1029	1114	8.8	1.28	33.7
	3000	70		5418418	687	1187	1285	10.2	1.28	38.7
Tyyppi 22										
	400	102		5418602	112	197	213	1.4	1.31	7.2
	500	102		5418603	141	246	267	1.7	1.31	8.5
	600	102	F062203006010300	5418604	169	295	321,320	2.0	1.31	10.1
	700	102	F062203007010300	5418605	197	345	374	2.4	1.31	11.4
	800	102		5418606	225	394	427	2.7	1.31	12.8
	900	102		5418607	253	443	481	3.1	1.31	14.2
	1000	102		5418608	282	492	534	3.4	1.31	15.6
	1100	102	F062203011010300	5418609	310	542	587	3.7	1.31	17.4
	1200	102		5418610	338	591	641	4.1	1.31	18.5
	1400	102		5418612	394	689	747	4.8	1.31	21.3
	1600	102	F062203016010300	5418613	451	788	854	5.4	1.31	24.2
	1800	102		5418614	507	886	961	6.1	1.31	27.1
	2000	102	F062203020010300	5418615	563	985	1068,1067	6.8	1.31	29.9



300

KORKEUS 300 mm	PITUUS	SYVYYS	Tuotenro/ LVI (VASEN)	Tuotenro/ LVI (OIKEA)	TEHO (W) 45/35/20°C	TEHO (W) 55/45/20°C	TEHO (W) 60/45/20°C	TILAVUUS (l)	N- eksponentti	PAINO (kg)
	2300	102	5418616		647	1132	1228	7.8	1.31	34.1
	2600	102	5418617		732	1280	1388	8.8	1.31	38.5
	3000	102	F062203030010300	5418618	845	1477	1602,1601	10.2	1.31	44.9
Tyyppi 33	400	152	5418802		157	275	299	2.0	1.31	1.3
	500	152	5418803		197	344	374	2.5	1.31	12.4
	600	152	5418804		236	413	448	3.1	1.31	14.5
	700	152	F063303007010300	5418805	275	482	523	3.6	1.31	16.7
	800	152	5418806		314	551	598	4.1	1.31	18.8
	900	152	F063303009010300	5418807	354,353	620	672	4.6	1.31	2.9
	1000	152	5418808		393	688	747	5.1	1.31	23.5
	1100	152	F063303011010300	5418809	432	757	822,821	5.6	1.31	25.2
	1200	152	5418810		471	826	896	6.1	1.31	27.3
	1400	152	5418812		550	964	1046	7.1	1.31	31.6
	1600	152	5418813		629	1101	1195	8.2	1.31	35.8
	1800	152	5418814		707	1239	1344	9.2	1.31	4.7
	2000	152	F063303020010300	5418815	786	1377	1493	10.2	1.31	44.3
	2300	152	F063303023010300	5418816	904	1583	1717	11.7	1.31	5.7
	2600	152	5418817		1021	1790	1941	13.3	1.31	57.9
	3000	152	F063303030010300	5418818	1179	2065	2240	15.3	1.31	65.6



400

KORKEUS 400 mm	PITUUS	SYVYYS	Tuotenumero/ LVI (VASEN)	Tuotenumero/ LVI (OIKEA)	TEHO (W) 45/35/20°C	TEHO (W) 55/45/20°C	TEHO (W) 60/45/20°C	TILAVUUS (l)	N- eksponentti	PAINO (kg)
Tyyppi 11										
	400	60	5418222		84	146	158	0.9	1.30	5.5
	500	60	F061104005010300	5418223	105	183	198	1.1	1.30	6.5
	600	60	F061104006010300	5418224	126	219	238	1.3	1.30	7.6
	700	60	5418225		147	256	277	1.5	1.30	8.7
	800	60	F061104008010300	5418226	168	292	317	1.8	1.30	9.7
	900	60	5418227		189	329	357	2.0	1.30	1.8
	1000	60	F061104010010300	5418228	210	366	396	2.2	1.30	11.8
	1100	60	F061104011010300	5418229	231	402	436	2.4	1.30	12.9
	1200	60	5418230		251	439	475	2.6	1.30	14.0
	1400	60	5418232		293	512	554	3.1	1.30	16.1
	1600	60	5418233		335	585	634	3.5	1.30	18.2
	1800	60	5418234		377	658	713	4.0	1.30	2.4
	2000	60	F061104020010300	5418235	419	731	792	4.4	1.30	22.5
	2300	60	5418236		482	841	911	5.1	1.30	25.7
	2600	60	F061104026010300	5418237	545	950	1030	5.7	1.30	28.9
	3000	60	5418238		629	1097	1189	6.6	1.30	33.2
Tyyppi 21										
	400	70	F062104004010300	5418422	115,114	199	215	1.8	1.29	7.7
	500	70	F062104005010300	5418423	143	249	270,269	2.3	1.29	9.4
	600	70	5418424		172	298	323	2.7	1.29	11.1
	700	70	F062104007010300	5418425	200	348	377	3.1	1.29	12.8
	800	70	F062104008010300	5418426	229	398	431	3.6	1.29	14.5
	900	70	5418427		258	448	485	4.0	1.29	16.2



400

KORKEUS 400 mm	PITUUS	SYVYYS	Tuotenro/ LVI (VASEN)	Tuotenro/ LVI (OIKEA)	TEHO (W) 45/35/20°C	TEHO (W) 55/45/20°C	TEHO (W) 60/45/20°C	TILAVUUS (l)	N- ekspONENTTI	PAINO (kg)
	1000	70		5418428	286	497	539	4.5	1.29	17.9
	1100	70	F062104011010300	5418429	315	547	592	5.0	1.29	19.6
	1200	70	F062104012010300	5418430	344	597	647,646	5.4	1.29	21.3
	1400	70		5418432	401	696	754	6.3	1.29	24.6
	1600	70	F062104016010300	5418433	458	796	862	7.2	1.29	28.3
	1800	70	F062104018010300	5418434	515	895	969	8.1	1.29	31.4
	2000	70		5418435	572	994	1077	9.0	1.29	34.8
	2300	70		5418436	658	1144	1239	10.3	1.29	39.9
	2600	70		5418437	744	1293	1401	11.7	1.29	44.9
	3000	70		5418438	859	1492	1616	13.5	1.29	51.7
Tyyppi 22										
	400	102	F062204004010300	5418622	142	249	270	1.8	1.32	9.2
	500	102		5418623	178	311	338	2.3	1.32	11.3
	600	102	F062204006010300	5418624	213	374	406,405	2.7	1.32	13.3
	700	102		5418625	248	436	473	3.1	1.32	15.0
	800	102		5418626	284	498	541	3.6	1.32	16.9
	900	102		5418627	319	560	608	4.0	1.32	18.8
	1000	102		5418628	355	623	676	4.5	1.32	2.7
	1100	102	F062204011010300	5418629	390	685	743	5.0	1.32	22.6
	1200	102		5418630	426	747	811	5.4	1.32	24.6
	1400	102	F062204014010300	5418632	497,496	872	946	6.3	1.32	28.4
	1600	102		5418633	568	996	1081	7.2	1.32	32.3
	1800	102	F062204018010300	5418634	639	1121	1216	8.1	1.32	36.1
	2000	102	F062204020010300	5418635	710,709	1245	1351	9.0	1.32	40.0



400

KORKEUS 400 mm	PITUUS	SYVYYS	Tuotenro/ LVI (VASEN)	Tuotenro/ LVI (OIKEA)	TEHO (W) 45/35/20°C	TEHO (W) 55/45/20°C	TEHO (W) 60/45/20°C	TILAVUUS (l)	N- eksponentti	PAINO (kg)
	2300	102	5418636		816	1432	1554	10.3	1.32	45.7
	2600	102	F062204026010300	5418637	923,922	1619	1757,1756	11.7	1.32	51.6
	3000	102	5418638		1064	1868	2027	13.5	1.32	59.2
Tyyppi 33	400	152	5418822		196	345	375	2.7	1.33	13.5
	500	152	F063304005010300	5418823	245	432	469,468	3.4	1.33	16.4
	600	152	5418824		294	518	562	4.0	1.33	19.2
	700	152	F063304007010300	5418825	343	604	656	4.7	1.33	22.1
	800	152	F063304008010300	5418826	392	691	750,749	5.4	1.33	25.0
	900	152	5418827		441	777	843	6.0	1.33	27.9
	1000	152	F063304010010300	5418828	490	863	937	6.7	1.33	3.8
	1100	152	F063304011010300	5418829	539	950	1031	7.4	1.33	33.6
	1200	152	5418830		588	1036	1125	8.0	1.33	36.5
	1400	152	5418832		686	1209	1312	9.4	1.33	42.3
	1600	152	5418833		784	1381	1499	10.7	1.33	48.5
	1800	152	F063304018010300	5418834	883,882	1554	1687,1686	12.1	1.33	53.9
	2000	152	F063304020010300	5418835	981,980	1726	1874	13.4	1.33	59.6
	2300	152	5418836		1128	1985	2155	15.4	1.33	68.2
	2600	152	5418837		1274	2244	2436	17.4	1.33	76.9
	3000	152	5418838		1471	2590	2811	20.1	1.33	88.4



450

KORKEUS 450 mm	PITUUS	SYVYYS	Tuotenro/ LVI (VASEN)	Tuotenro/ LVI (OIKEA)	TEHO (W) 45/35/20°C	TEHO (W) 55/45/20°C	TEHO (W) 60/45/20°C	TILAVUUS (l)	N- ekspONENTTI	PAINO (kg)
Tyyppi 11										
	400	60		5418242	93	162	176	1.0	1.30	6.4
	500	60		5418243	116	203	220	1.3	1.30	7.6
	600	60	F061104506010300	5418244	139	243	264	1.5	1.30	8.9
	700	60		5418245	163	284	308	1.8	1.30	1.2
	800	60		5418246	186	325	352	2.0	1.30	11.4
	900	60		5418247	209	365	396	2.3	1.30	12.7
	1000	60	F061104510010300	5418248	232	406	440	2.5	1.30	14.0
	1100	60		5418249	256	446	484	2.8	1.30	15.2
	1200	60	F061104512010300	5418250	279	487	528	3.0	1.30	16.5
	1400	60		5418252	325	568	616	3.5	1.30	19.4
	1600	60	F061104516010300	5418253	372	649	704,703	4.0	1.30	21.5
	1800	60	F061104518010300	5418254	418	730	792,791	4.5	1.30	24.5
	2000	60	F061104520010300	5418255	465	811	880,879	5.0	1.30	26.6
	2300	60		5418256	535	933	1011	5.8	1.30	3.4
	2600	60	F061104526010300	5418257	604	1055	1143	6.5	1.30	34.2
	3000	60		5418258	697	1217	1319	7.5	1.30	39.2
Tyyppi 21										
	400	70	F062104504010300	5418442	125	218	236	2.0	1.30	9.3
	500	70	F062104505010300	5418443	157	273	296	2.5	1.30	11.3
	600	70	F062104506010300	5418444	188	327	355	3.0	1.30	13.4
	700	70		5418445	219	382	414	3.5	1.30	15.4
	800	70		5418446	250	436	473	4.0	1.30	17.4
	900	70		5418447	282	491	532	4.5	1.30	19.4



450

KORKEUS 450 mm	PITUUS	SYVYYS	Tuotenro/ LVI (VASEN)	Tuotenro/ LVI (OIKEA)	TEHO (W) 45/35/20°C	TEHO (W) 55/45/20°C	TEHO (W) 60/45/20°C	TILAVUUS (l)	N- ekspONENTTI	PAINO (kg)
	1000	70		5418448	313	545	591	5.0	1.30	21.4
	1100	70	F062104511010300	5418449	344	600	650	5.5	1.30	23.5
	1200	70		5418450	376	654	709	6.0	1.30	25.5
	1400	70		5418452	438	764	828	7.0	1.30	29.5
	1600	70		5418453	501	873	946	8.0	1.30	33.6
	1800	70	F062104518010300	5418454	564,563	982	1064	9.0	1.30	37.7
	2000	70		5418455	626	1091	1182	10.0	1.30	41.6
	2300	70		5418456	720	1254	1360	11.5	1.30	47.7
	2600	70		5418457	814	1418	1537	13.0	1.30	53.8
	3000	70		5418458	939	1636	1773	15.0	1.30	61.9
Tyyppi 22										
	400	102	F062204504010300	5418642	156	274	298,297	2.0	1.32	1.6
	500	102		5418643	195	343	372	2.5	1.32	13.0
	600	102		5418644	234	411	446	3.0	1.32	15.3
	700	102		5418645	273	480	521	3.5	1.32	17.6
	800	102		5418646	312	548	595	4.0	1.32	19.9
	900	102		5418647	351	617	669	4.5	1.32	22.2
	1000	102		5418648	390	685	744	5.0	1.32	24.5
	1100	102	F062204511010300	5418649	429	754	818	5.5	1.32	26.8
	1200	102	F062204512010300	5418650	468	822	892	6.0	1.32	29.1
	1400	102		5418652	546	960	1042	7.0	1.32	33.7
	1600	102	F062204516010300	5418653	624,623	1097	1190	8.0	1.32	38.3
	1800	102	F062204518010300	5418654	702	1234	1339	9.0	1.32	43.0
	2000	102	F062204520010300	5418655	780,779	1371	1488,1487	10.0	1.32	47.6



450

KORKEUS 450 mm	PITUUS	SYVYYS	Tuotenro/ LVI (VASEN)	Tuotenro/ LVI (OIKEA)	TEHO (W) 45/35/20°C	TEHO (W) 55/45/20°C	TEHO (W) 60/45/20°C	TILAVUUS (l)	N- eksponentti	PAINO (kg)
	2300	102	5418656		896	1576	1711	11.5	1.32	54.5
	2600	102	5418657		1013	1782	1934	13.0	1.32	61.4
	3000	102	F062204530010300	5418658	1169	2056	2232,2231	15.0	1.32	7.6
Tyyppi 33	400	152	5418842		215	379	411	3.0	1.33	15.8
	500	152	5418843		268	473	514	3.8	1.33	19.2
	600	152	F063304506010300	5418844	322	568	617	4.5	1.33	22.7
	700	152	5418845		375	663	719	5.3	1.33	26.1
	800	152	F063304508010300	5418846	429	757	822	6.0	1.33	29.6
	900	152	5418847		483	852	925	6.8	1.33	33.7
	1000	152	5418848		536	947	1028	7.5	1.33	36.5
	1100	152	F063304511010300	5418849	590	1041	1131	8.3	1.33	39.9
	1200	152	5418850		644	1136	1234	9.0	1.33	43.3
	1400	152	F063304514010300	5418852	751	1326	1440,1439	10.5	1.33	5.2
	1600	152	F063304516010300	5418853	858	1515	1645	12.0	1.33	57.1
	1800	152	5418854		965	1704	1850	13.5	1.33	64.1
	2000	152	5418855		1073	1894	2056	15.0	1.33	7.9
	2300	152	5418856		1234	2178	2365	17.3	1.33	81.2
	2600	152	5418857		1394	2462	2673	19.5	1.33	91.6
	3000	152	5418858		1609	2840	3084	22.5	1.33	107.4



500

KORKEUS 500 mm	PITUUS	SYVYYS	Tuotenro/ LVI (VASEN)	Tuotenro/ LVI (OIKEA)	TEHO (W) 45/35/20°C	TEHO (W) 55/45/20°C	TEHO (W) 60/45/20°C	TILAVUUS (l)	N- eksponentti	PAINO (kg)
Tyyppi 11										
	400	60	F061105004010300	5418262	102	178	193	1.1	1.31	6.5
	500	60		5418263	127	223	241	1.4	1.31	7.8
	600	60		5418264	153	267	290	1.6	1.31	9.2
	700	60		5418265	178	312	338	1.9	1.31	1.6
	800	60	F061105008010300	5418266	204	356	386	2.2	1.31	12.0
	900	60	F061105009010300	5418267	229	401	434	2.4	1.31	13.3
	1000	60	F061105010010300	5418268	255	445	483	2.7	1.31	14.8
	1100	60	F061105011010300	5418269	280	490	531	3.0	1.31	16.4
	1200	60		5418270	306	534	579	3.2	1.31	17.5
	1400	60	F061105014010300	5418272	357	623	676	3.8	1.31	2.2
	1600	60		5418273	408	712	772	4.3	1.31	22.9
	1800	60	F061105018010300	5418274	459	801	869	4.9	1.31	25.7
	2000	60	F061105020010300	5418275	510	890	965	5.4	1.31	28.4
	2300	60	F061105023010300	5418276	586	1024	1110	6.2	1.31	32.6
	2600	60	F061105026010300	5418277	663	1158	1255	7.0	1.31	36.7
	3000	60		5418278	764	1336	1448	8.1	1.31	43.0
Tyyppi 21										
	400	70		5418462	136	237	257	2.2	1.31	9.6
	500	70	F062105005010300	5418463	170	296	321	2.8	1.31	11.7
	600	70		5418464	204	356	386	3.3	1.31	13.8
	700	70	F062105007010300	5418465	237	415	450	3.9	1.31	15.9
	800	70		5418466	271	474	514	4.4	1.31	18.1
	900	70		5418467	305	533	578	5.0	1.31	2.1



500

KORKEUS 500 mm	PITUUS	SYVYYS	Tuotenro/ LVI (VASEN)	Tuotenro/ LVI (OIKEA)	TEHO (W) 45/35/20°C	TEHO (W) 55/45/20°C	TEHO (W) 60/45/20°C	TILAVUUS (l)	N- ekspONENTTI	PAINO (kg)
	1000	70	F062105010010300	5418468	339	593	643	5.5	1.31	22.2
	1100	70	F062105011010300	5418469	373	652	707	6.0	1.31	24.3
	1200	70	5418470		407	711	771	6.6	1.31	26.4
	1400	70	F062105014010300	5418472	475	830	900	7.7	1.31	3.5
	1600	70	F062105016010300	5418473	543	948	1029,1028	8.8	1.31	34.7
	1800	70	F062105018010300	5418474	611	1067	1157	9.9	1.31	38.9
	2000	70	F062105020010300	5418475	679,678	1185	1285	11.0	1.31	43.9
	2300	70	F062105023010300	5418476	780	1363	1478	12.7	1.31	49.4
	2600	70	F062105026010300	5418477	882	1541	1671	14.3	1.31	55.6
	3000	70	5418478		1018	1778	1928	16.5	1.31	64.0
Tyyppi 22										
	400	102	5418662		169	299	324	2.2	1.33	11.2
	500	102	F062205005010300	5418663	212	373	405	2.8	1.33	13.7
	600	102	5418664		254	448	486	3.3	1.33	16.4
	700	102	F062205007010300	5418665	297,296	522	567	3.9	1.33	18.6
	800	102	5418666		339	597	648	4.4	1.33	2.9
	900	102	F062205009010300	5418667	381	672	729	5.0	1.33	23.4
	1000	102	5418668		424	746	810	5.5	1.33	25.8
	1100	102	F062205011010300	5418669	466	821	891	6.0	1.33	28.3
	1200	102	5418670		508	896	972	6.6	1.33	3.6
	1400	102	F062205014010300	5418672	593	1045	1134	7.7	1.33	35.5
	1600	102	5418673		678	1194	1296	8.8	1.33	4.3
	1800	102	5418674		762	1343	1458	9.9	1.33	45.2
	2000	102	F062205020010300	5418675	847	1493	1620	11.0	1.33	51



500

KORKEUS 500 mm	PITUUS	SYVYYS	Tuotenro/ LVI (VASEN)	Tuotenro/ LVI (OIKEA)	TEHO (W) 45/35/20°C	TEHO (W) 55/45/20°C	TEHO (W) 60/45/20°C	TILAVUUS (l)	N- eksponentti	PAINO (kg)
	2300	102	5418676		974	1717	1863	12.7	1.33	57.3
	2600	102	F062205026010300	5418677	1102,1101	1940	2106	14.3	1.33	64.6
	3000	102	F062205030010300	5418678	1271	2239	2431,2430	16.5	1.33	74.3
Tyyppi 33	400	152	F063305004010300	5418862	232	411	447	3.3	1.34	16.6
	500	152	F063305005010300	5418863	291,290	514	559,558	4.1	1.34	2.2
	600	152	5418864		348	617	670	4.9	1.34	23.9
	700	152	5418865		407	719	782	5.7	1.34	27.6
	800	152	5418866		465	822	893	6.6	1.34	31.1
	900	152	F063305009010300	5418867	523	925	1005	7.4	1.34	34.8
	1000	152	F063305010010300	5418868	581	1028	1116	8.2	1.34	38.5
	1100	152	F063305011010300	5418869	639	1131	1228	9.0	1.34	42.4
	1200	152	F063305012010300	5418870	697	1233	1340	9.8	1.34	45.7
	1400	152	5418872		813	1439	1563	11.5	1.34	52.9
	1600	152	F063305016010300	5418873	930,929	1645	1786	13.1	1.34	6.2
	1800	152	5418874		1045	1850	2010	14.8	1.34	67.5
	2000	152	5418875		1162	2056	2233	16.4	1.34	74.7
	2300	152	5418876		1336	2364	2568	18.9	1.34	85.6
	2600	152	5418877		1510	2672	2903	21.3	1.34	96.6
	3000	152	5418878		1742	3084	3349	24.6	1.34	111.9



550

KORKEUS 550 mm	PITUUS	SYVYYS	Tuoteno/ LVI	TEHO (W) 45/35/20°C	TEHO (W) 55/45/20°C	TEHO (W) 60/45/20°C	TILAVUUS (l)	N- eksponentti	PAINO (kg)
Tyyppi 11									
400	60		F061105504010300	111	193	210	1.2	1.31	7.3
600	60		F061105506010300	166	290	315	1.8	1.31	1.2
900	60		F061105509010300	249	435	472	2.7	1.31	14.7
1100	60		F061105511010300	304	532	577	3.3	1.31	17.6
1200	60		F061105512010300	332	580	629	3.6	1.31	19.1
1600	60		F061105516010300	443	774	839	4.8	1.31	25.5
2000	60		F061105520010300	553	967	1049	6.0	1.31	3.9
2300	60		F061105523010300	636	1112	1206	6.9	1.31	35.3
3000	60		F061105530010300	830	1451	1573	9.0	1.31	45.7
Tyyppi 21									
400	70		F062105504010300	146	255	277	2.4	1.31	1.4
700	70		F062105507010300	255	447	484	4.3	1.31	17.7
800	70		F062105508010300	291	511	554	4.9	1.31	2.2
1200	70		F062105512010300	437	766	831	7.3	1.31	30.0
1600	70		F062105516010300	583	1021	1107	9.8	1.31	39.8
2600	70		F062105526010300	947	1659	1799	15.9	1.31	64.3
3000	70		F062105530010300	1093	1915	2076	18.3	1.31	74.9
Tyyppi 22									
400	102		F062205504010300	183	322	350	2.4	1.33	12.2
500	102		F062205505010300	228	403	437	3.0	1.33	14.9
800	102		F062205508010300	365	645	700	4.9	1.33	23.2
1000	102		F062205510010300	457	806	875	6.1	1.33	28.7
1200	102		F062205512010300	548	967	1050	7.3	1.33	34.3
1400	102		F062205514010300	639	1128	1225	8.5	1.33	39.8



550

KORKEUS 550 mm	PITUUS	SYVYYS	Tuotenro/ LVI	TEHO (W) 45/35/20°C	TEHO (W) 55/45/20°C	TEHO (W) 60/45/20°C	TILAVUUS (l)	N- eksponentti	PAINO (kg)
	1800	102	F062205518010300	822	1451	1575	11.0	1.33	5.8
	2000	102	F062205520010300	913	1612	1750	12.2	1.33	56.3
	2600	102	F062205526010300	1187	2095	2275	15.9	1.33	72.9
	3000	102	F062205530010300	1370	2418	2625	18.3	1.33	83.9
Tyyppi 33									
	400	152	F063305504010300	250	443	481	3.6	1.34	18.0
	500	152	F063305505010300	312	553	601	4.5	1.34	22.2
	700	152	F063305507010300	437	775	841	6.3	1.34	31
	800	152	F063305508010300	499	885	962	7.2	1.34	34.2
	1600	152	F063305516010300	998	1770	1923	14.4	1.34	66.7
	1800	152	F063305518010300	1123	1992	2164	16.2	1.34	74.8
	2000	152	F063305520010300	1248	2213	2404	18.0	1.34	83.0
	2300	152	F063305523010300	1435	2545	2765	20.7	1.34	95.2



600

KORKEUS 600 mm	PITUUS	SYVYYS	Tuotenro/ LVI (VASEN)	Tuotenro/ LVI (OIKEA)	TEHO (W) 45/35/20°C	TEHO (W) 55/45/20°C	TEHO (W) 60/45/20°C	TILAVUUS (l)	N- ekspONENTTI	PAINO (kg)
Tyyppi 11										
	400	60		5418282	119	208	226	1.3	1.31	7.9
	500	60	F061106005010300	5418283	149	260	282	1.6	1.31	9.5
	600	60	F061106006010300	5418284	179	313	339	1.9	1.31	11.1
	700	60		5418285	208	365	396	2.2	1.31	12.7
	800	60	F061106008010300	5418286	238	417	452	2.6	1.31	14.4
	900	60	F061106009010300	5418287	268	469	508	2.9	1.31	16.0
	1000	60	F061106010010300	5418288	298	521	565	3.2	1.31	17.6
	1100	60	F061106011010300	5418289	327	573	622,621	3.5	1.31	19.2
	1200	60		5418290	357	625	678	3.8	1.31	2.9
	1400	60		5418292	417	729	791	4.5	1.31	24.4
	1600	60	F061106016010300	5418293	476	834	904	5.1	1.31	27.3
	1800	60		5418294	536	938	1017	5.8	1.31	3.5
	2000	60		5418295	595	1042	1130	6.4	1.31	33.7
	2300	60		5418296	684	1198	1299	7.4	1.31	38.6
	2600	60	F061106026010300	5418297	774	1354	1469	8.3	1.31	43.4
	3000	60		5418298	893	1563	1695	9.6	1.31	49.8
Tyyppi 21										
	400	70	F062106004010300	5418482	155	273	296	2.6	1.32	11.5
	500	70		5418483	194	341	370	3.3	1.32	14.4
	600	70		5418484	233	409	444	4.0	1.32	16.6
	700	70		5418485	272	478	518	4.6	1.32	19.2
	800	70	F062106008010300	5418486	311	546	592	5.3	1.32	21.7
	900	70		5418487	349	614	666	5.9	1.32	24.3



600

KORKEUS 600 mm	PITUUS	SYVYYS	Tuotenro/ LVI (VASEN)	Tuotenro/ LVI (OIKEA)	TEHO (W) 45/35/20°C	TEHO (W) 55/45/20°C	TEHO (W) 60/45/20°C	TILAVUUS (l)	N- ekspONENTTI	PAINO (kg)
	1000	70	F062106010010300	5418488	388	682	740	6.6	1.32	26.8
	1100	70	5418489		427	751	814	7.3	1.32	29.4
	1200	70	F062106012010300	5418490	466	819	889,888	7.9	1.32	31.9
	1400	70	F062106014010300	5418492	544,543	955	1037,1036	9.2	1.32	37.3
	1600	70	5418493		621	1092	1185	10.6	1.32	42.1
	1800	70	F062106018010300	5418494	699	1228	1333,1332	11.9	1.32	47.2
	2000	70	5418495		776	1365	1481	13.2	1.32	52.3
	2300	70	5418496		893	1569	1703	15.2	1.32	60.0
	2600	70	5418497		1009	1774	1925	17.2	1.32	67.6
	3000	70	F062106030010300	5418498	1165,1164	2047	2221	19.8	1.32	77.8
Tyyppi 22										
	400	102	F062206004010300	5418682	195	346	375	2.6	1.34	13.8
	500	102	5418683		244	432	469	3.3	1.34	16.8
	600	102	5418684		293	518	563	4.0	1.34	19.6
	700	102	F062206007010300	5418685	342	605	657	4.6	1.34	22.6
	800	102	F062206008010300	5418686	391	691	750	5.3	1.34	25.5
	900	102	5418687		440	777	844	5.9	1.34	28.4
	1000	102	F062206010010300	5418688	488	864	938	6.6	1.34	31.4
	1100	102	F062206011010300	5418689	537	950	1032	7.3	1.34	34.3
	1200	102	5418690		586	1037	1126	7.9	1.34	37.2
	1400	102	F062206014010300	5418692	684	1209	1314,1313	9.2	1.34	43.9
	1600	102	5418693		781	1382	1501	10.6	1.34	49.0
	1800	102	5418694		879	1555	1689	11.9	1.34	54.9
	2000	102	F062206020010300	5418695	977	1728	1876	13.2	1.34	67



600

KORKEUS 600 mm	PITUUS	SYVYYS	Tuotenro/ LVI (VASEN)	Tuotenro/ LVI (OIKEA)	TEHO (W) 45/35/20°C	TEHO (W) 55/45/20°C	TEHO (W) 60/45/20°C	TILAVUUS (l)	N- eksponentti	PAINO (kg)
	2300	102	5418696		1123	1987	2158	15.2	1.34	69.5
	2600	102	F062206026010300	5418697	1270	2246	2439	17.2	1.34	78.3
	3000	102	5418698		1465	2591	2815	19.8	1.34	90.0
Tyyppi 33	400	152	5418882		266	473	514	3.9	1.35	2.8
	500	152	F063306005010300	5418883	333	592	643	4.9	1.35	24.5
	600	152	F063306006010300	5418884	399	710	772,771	5.9	1.35	28.9
	700	152	5418885		466	828	900	6.9	1.35	33.3
	800	152	5418886		532	946	1029	7.8	1.35	37.6
	900	152	F063306009010300	5418887	599	1065	1157	8.8	1.35	42.2
	1000	152	F063306010010300	5418888	665	1183	1286	9.8	1.35	46.4
	1100	152	F063306011010300	5418889	732	1301	1415,1414	10.8	1.35	5.9
	1200	152	5418890		798	1420	1543	11.8	1.35	55.2
	1400	152	F063306014010300	5418892	932,931	1656	1800	13.7	1.35	64.0
	1600	152	F063306016010300	5418893	1065,1064	1893	2058,2057	15.7	1.35	72.8
	1800	152	5418894		1197	2129	2315	17.6	1.35	81.5
	2000	152	5418895		1330	2366	2572	19.6	1.35	9.4
	2300	152	5418896		1530	2721	2958	22.5	1.35	105.5
	2600	152	F063306026010300	5418897	1730	3076	3344,3343	25.5	1.35	116.7
	3000	152	5418898		1996	3549	3858	29.4	1.35	134.3



900

KORKEUS 900 mm	PITUUS	SYVYYS	Tuotenro/ LVI (VASEN)	Tuotenro/ LVI (OIKEA)	TEHO (W) 45/35/20°C	TEHO (W) 55/45/20°C	TEHO (W) 60/45/20°C	TILAVUUS (l)	N- ekspONENTTI	PAINO (kg)
Tyyppi 11										
	400	60	F061109004010300	5418302	166	291	316	1.8	1.32	11.9
	500	60		5418303	208	364	395	2.3	1.32	14.3
	600	60		5418304	249	437	474	2.7	1.32	16.8
	700	60	F061109007010300	5418305	291	510	553	3.1	1.32	19.2
	800	60	F061109008010300	5418306	332	583	632	3.6	1.32	21.7
	900	60		5418307	373	655	711	4.0	1.32	24.2
	1000	60	F061109010010300	5418308	415	728	790	4.5	1.32	26.7
	1100	60	F061109011010300	5418309	457	801	869	5.0	1.32	29.2
	1200	60	F061109012010300	5418310	498	874	948	5.4	1.32	31.6
	1400	60	F061109014010300	5418312	581	1019	1106	6.3	1.32	36.6
	1600	60	F061109016010300	5418313	664	1165	1264	7.2	1.32	41.6
	1800	60		5418314	747	1311	1422	8.1	1.32	46.5
	2000	60		5418315	830	1456	1580	9.0	1.32	51.5
	2300	60	F061109023010300	5418316	955	1675	1817	10.3	1.32	58.9
	2600	60		5418317	1079	1893	2054	11.7	1.32	66.4
	3000	60		5418318	1245	2185	2370	13.5	1.32	76.3
Tyyppi 21										
	400	70	F062109004010300	5418502	212	376	408	3.6	1.34	16.7
	500	70	F062109005010300	5418503	265	470	510	4.5	1.34	2.6
	600	70		5418504	318	563	612	5.4	1.34	24.3
	700	70		5418505	371	657	714	6.3	1.34	28.6
	800	70		5418506	424	751	816	7.2	1.34	31.8
	900	70	F062109009010300	5418507	477	845	918	8.1	1.34	35.6



900

KORKEUS 900 mm	PITUUS	SYVYYS	Tuotenro/ LVI (VASEN)	Tuotenro/ LVI (OIKEA)	TEHO (W) 45/35/20°C	TEHO (W) 55/45/20°C	TEHO (W) 60/45/20°C	TILAVUUS (l)	N- ekspONENTTI	PAINO (kg)
	1000	70		5418508	530	939	1020	9.0	1.34	39.5
	1100	70		5418509	583	1033	1122	9.9	1.34	43.2
	1200	70	F062109012010300	5418510	636	1127	1224	10.8	1.34	47.0
	1400	70		5418512	742	1315	1428	12.6	1.34	54.5
	1600	70	F062109016010300	5418513	849,848	1502	1632	14.4	1.34	62.8
	1800	70	F062109018010300	5418514	955,954	1690	1836	16.2	1.34	69.6
	2000	70		5418515	1060	1878	2040	18.0	1.34	77.2
	2300	70		5418516	1219	2160	2346	20.7	1.34	88.5
	2600	70		5418517	1379	2442	2653	23.4	1.34	101.8
	3000	70		5418518	1591	2817	3060	27.0	1.34	115.0
Tyyppi 22										
	400	102	F062209004010300	5418702	268	478	520	3.6	1.36	19.8
	500	102	F062209005010300	5418703	335	597	650,649	4.5	1.36	24.2
	600	102		5418704	402	717	780	5.4	1.36	28.7
	700	102		5418705	469	836	910	6.3	1.36	33.2
	800	102	F062209008010300	5418706	536	956	1039	7.2	1.36	37.7
	900	102	F062209009010300	5418707	603	1075	1169	8.1	1.36	42.2
	1000	102		5418708	670	1194	1299	9.0	1.36	46.7
	1100	102	F062209011010300	5418709	737	1314	1429	9.9	1.36	51.2
	1200	102		5418710	804	1433	1559	10.8	1.36	55.7
	1400	102		5418712	937	1672	1819	12.6	1.36	64.7
	1600	102	F062209016010300	5418713	1072,1071	1911	2079,2078	14.4	1.36	73.7
	1800	102		5418714	1205	2150	2338	16.2	1.36	82.7
	2000	102		5418715	1339	2389	2598	18.0	1.36	91.6



900

KORKEUS 900 mm	PITUUS	SYVYYS	Tuoteno/ LVI (VASEN)	Tuoteno/ LVI (OIKEA)	TEHO (W) 45/35/20°C	TEHO (W) 55/45/20°C	TEHO (W) 60/45/20°C	TILAVUUS (l)	N- eksponentti	PAINO (kg)
	2300	102	5418716		1540	2747	2988	20.7	1.36	107.2
	2600	102	F062209026010300	5418717	1741	3106	3378,3377	23.4	1.36	118.7
	3000	102	F062209030010300	5418718	2009	3583	3897,3896	27.0	1.36	136.6
Tyyppi 33	400	152	F063309004010300	5418902	364	651	708	5.3	1.36	28.7
	500	152	5418903		455	814	885	6.7	1.36	35.4
	600	152	F063309006010300	5418904	547,546	976	1062	8.0	1.36	42.9
	700	152	5418905		637	1139	1239	9.3	1.36	48.8
	800	152	F063309008010300	5418906	729	1302	1416	10.6	1.36	55.5
	900	152	F063309009010300	5418907	820	1465	1593	12.0	1.36	62.3
	1000	152	F063309010010300	5418908	911	1627	1770	13.3	1.36	69.0
	1100	152	F063309011010300	5418909	1002	1790	1947	14.6	1.36	75.6
	1200	152	F063309012010300	5418910	1093	1953	2124	16.0	1.36	82.3
	1400	152	5418912		1275	2278	2478	18.6	1.36	95.7
	1600	152	5418913		1457	2604	2832	21.3	1.36	111.3
	1800	152	F063309018010300	5418914	1640,1639	2929	3187,3186	23.9	1.36	122.6
	2000	152	F063309020010300	5418915	1822,1821	3255	3541,3540	26.6	1.36	136.0
	2300	152	5418916		2095	3743	4072	30.6	1.36	156.8
	2600	152	5418917		2368	4231	4603	34.6	1.36	176.2
	3000	152	F063309030010300	5418918	2733,2732	4882	5311,5310	39.9	1.36	207.0