



Andmeleht
2026-06-07

Plint

Madalaim klassikaline paneelradiaator paigaldamiseks suurte akende alla.



- ✓ Mitmekülgne paigaldus
- ✓ Kõrge ühilduvus
- ✓ Korrosioonikindel
- ✓ Tõhus kütmine
- ✓ Disaini paindlikkus

Plint paneelradiaator, vaid 200 mm kõrge, ideaalne suurte akende ja modernsete interjööride jaoks; kõrge kvaliteediline viimistlus ja madal paigaldusjoon; RAL 9016 valge.



Kasutusala

Plint radiaatorid sobivad suurte klaaspindadega ruumidesse (vitriinid, talveaiad). Kõrgus 200 mm, pikkus 600–3000 mm, 6 ühenduspunkti, sein- või põrandapaigaldus.

Mõõdistamine

Õige tootevaliku tagamiseks kasutage meie kalkulaatoreid ja tootekatalooge. Kui vajate abi, võtke ühendust meie müügimeeskonnaga.

Kasutamine

Plint radiaator paigalda sobivate sein- või põrandakronsteinidega, tagades, et kõik kuus ühenduspunkti oleksid suletud ja ühendatud vastavalt projekteeritud veesyötoskeemile; kõrge niiskusega aladel vali mudel lisakorrosioonikaitsega.

AMA-tekst

Plint paneel on traditsiooniline madal radiaator, 200 mm kõrgune, sobib suurte akende ette ja modernsetesse interjööridesse. Alumine või külgühendus (pärast ventiilisüdamiku eemaldamist). Saab paigaldada seinale või põrandale (jalad eraldi tellitavad). RAL 9016; muud toonid tellimisel. Garantii 10 aastat.



Spetsifikatsioonid

OMADUSED	ÜHIK	VÄÄRTUSED
ETIM-klass		EC011022
Materjal		Terase
Tüüp		21, 22, 33, 44
Pinnastruktuur		Profiilitud
Maksimaalne töö rõhk	bar	10
Standardühenduste arv		2
Soojusandmine vastavalt EN 442 tunnustatud laborile		Jah
Maksimaalne töötemperatuur	°C	110
Standardvärv		Jah
Värv		Valge
RAL-number		9016
Rest/Katteplaat		Jah
Rest/Katteplaat		Jah
Läikeväärtus		Särav
Keerme mõõt (toll)		1/2 tolli
Ühenduskeere		Sisemine keere
Ühepunktiühendusega		Jah
Õhutusühendusega		Jah
Õhutusventiili/õhutusavaga		Jah
Tühjendusvõimalusega		Jah



Ressursid



ProductImage - Panel radiator Plint, 200 mm.

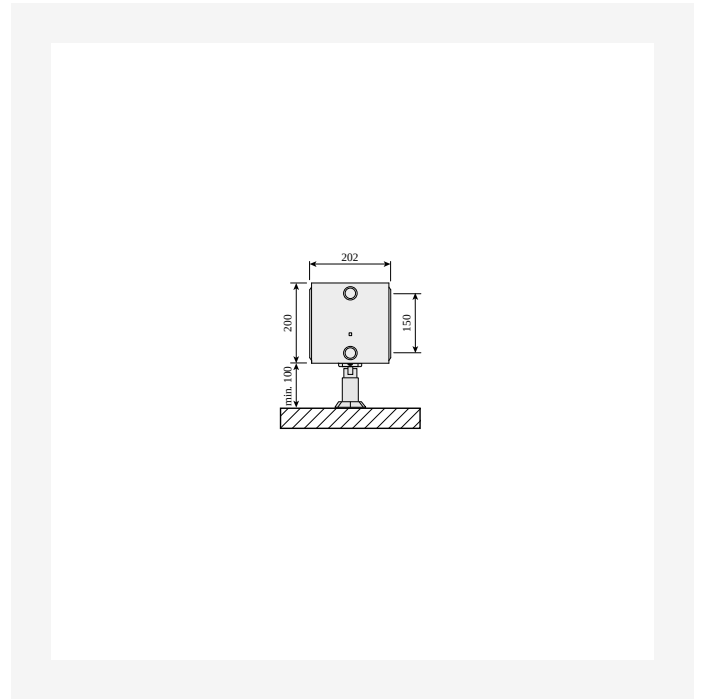

DimensionalDrawing - Plint, tüüp 44, põrandakinnitustega, külgsaade

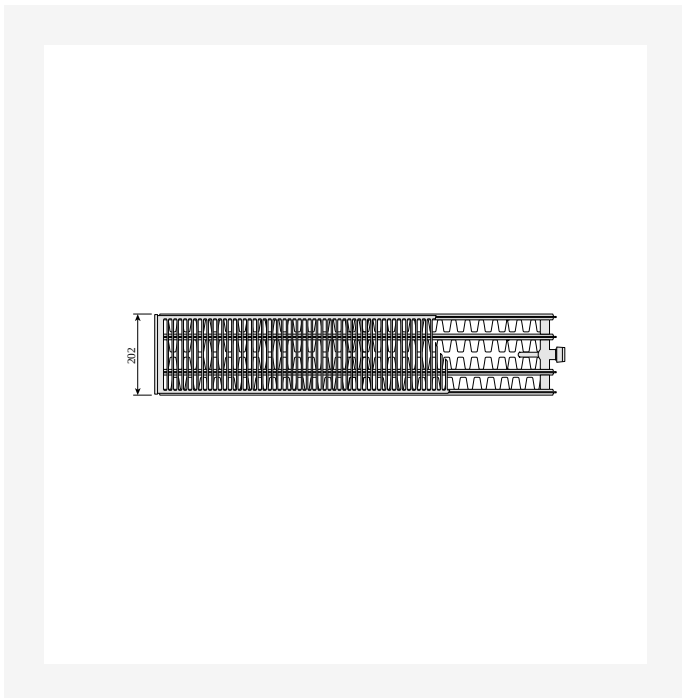

DimensionalDrawing - Plint, tüüp 44, pealtvaade

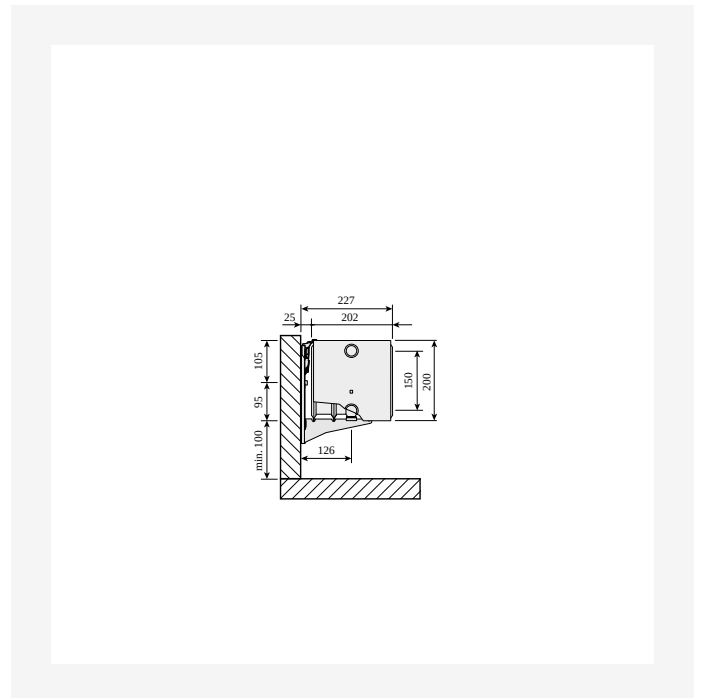

DimensionalDrawing - Plint, tüüp 44, külgsaade Monclac seinakanduritega



Ressursid



DimensionalDrawing - Plint, tüüp 33, pealtvaade

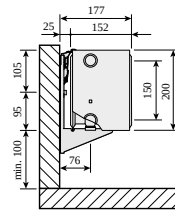

DimensionalDrawing - Plint, tüüp 33, külgsaade Monclac seinakanduritega

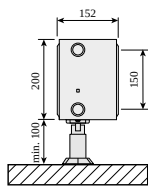

DimensionalDrawing - Plint, tüüp 33, põrandakinnitustega, külgsaade



DimensionalDrawing - Plint, tüüp 22, pealtvaade



Ressursid

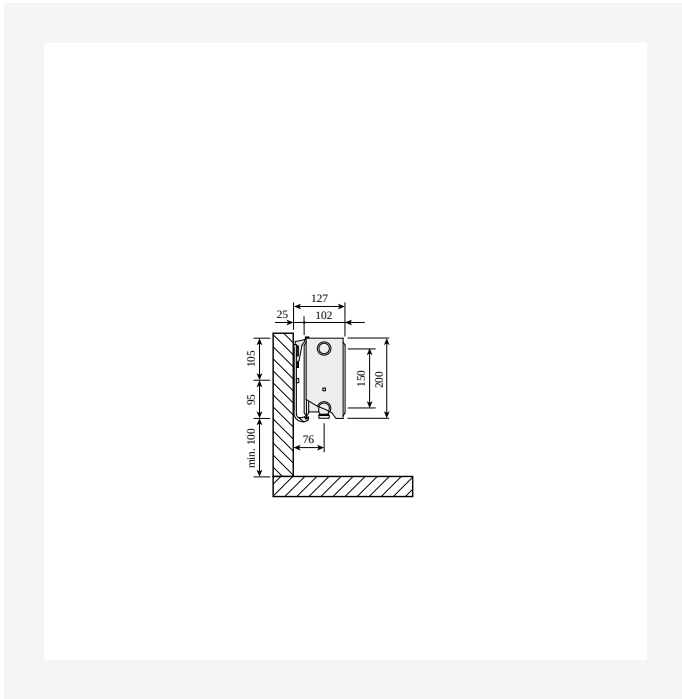

DimensionalDrawing - Plint, tüüp 22, külgsaade Monclac seinakanduritega

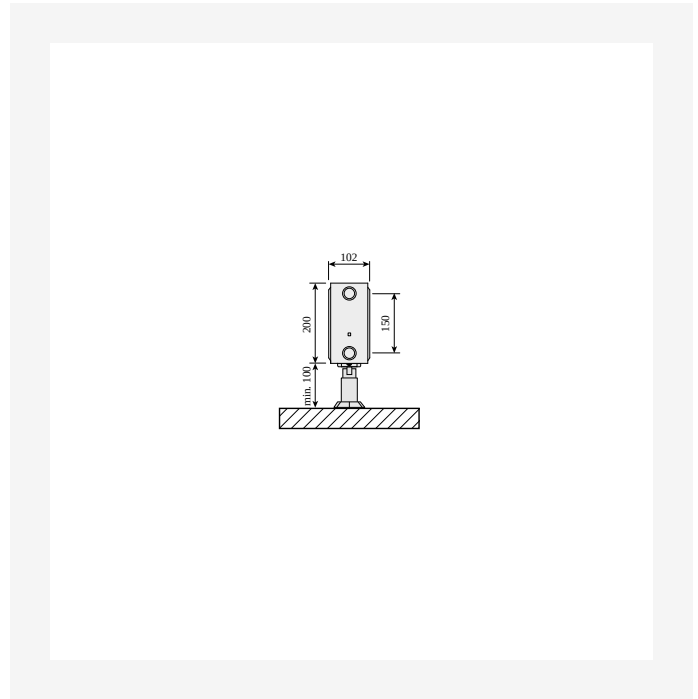

DimensionalDrawing - Plint, type 22, põrandakinnitustega, külgsaade

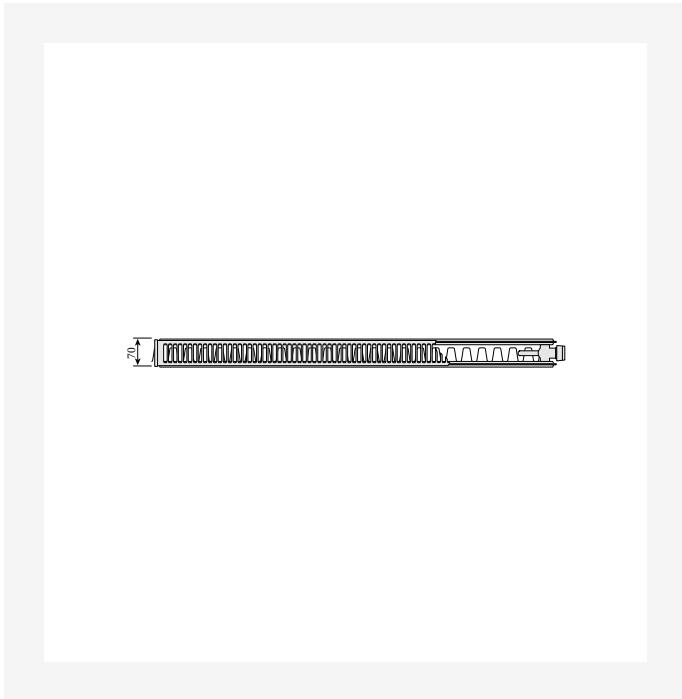

DimensionalDrawing - Plint, type 21s, pealtsaade

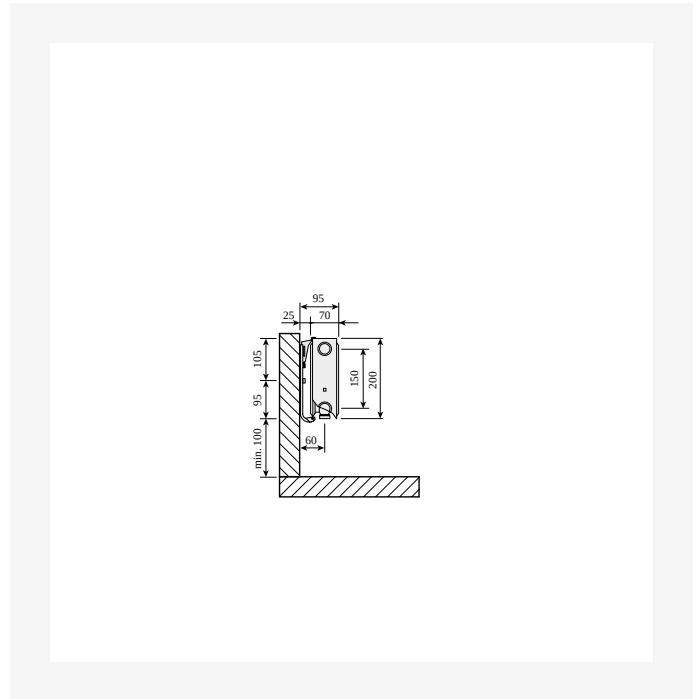

DimensionalDrawing - Plint, type 21s, külgsaade Monclac seinakanduritega



Ressursid

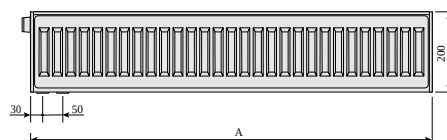
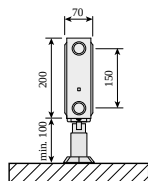

DimensionalDrawing - Plint, type 21s, pörandakinnitustega, külgsaade

DimensionalDrawing - Plint, Plint P ja Plint R, tagantvaade

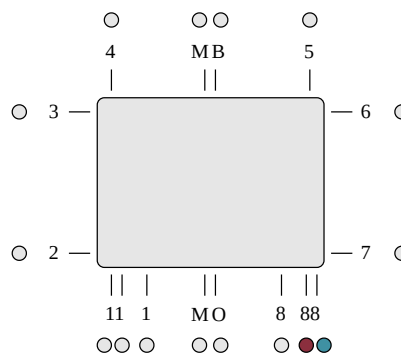
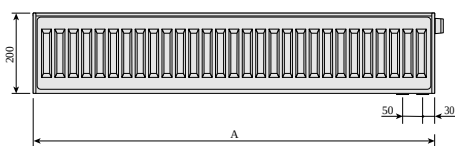

DimensionalDrawing - Plint, eestvaade

DimensionalDrawing - ETIM 88 LR alumine ühendus. Integreeritud ventiiliga alumine ühendus nõuab ventiilisisestiku kasutamist. Kasutamata ühendused on suletud.



Ressursid

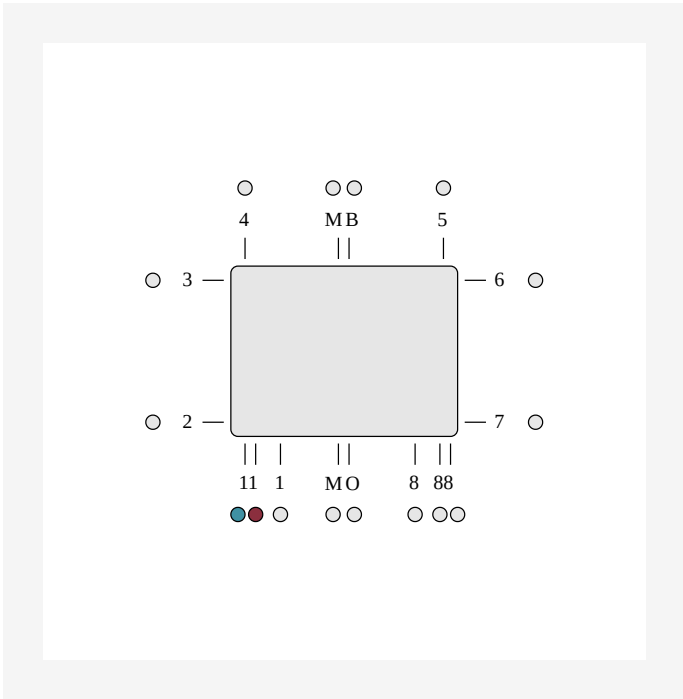

DimensionalDrawing - ETIM 11 alumine ühendus, sisend paremal, väljund vasakul. Alumine ühendus integreeritud kapillaartoruga nõuab ventiiliinserti kasutamist. Kasutamata ühendused on suletud.



Seotud tooted



Ventiili sisetükk M30 OV



Top Grill ©



Õhutus- ja pimekorgi komplekt



Plint põrandakronstein



Aerosool parandusvärv



Küljepaneel ©



Õhutusvõti



Monclac Plint seinakronstein



Parandussvärvi sprej



Evosense



200

KÕRGUS 200 mm	PIKKUS	SÜGAVUS		Võimsus (W) 45/35/20°C	Võimsus (W) 55/45/20°C	Võimsus (W) 60/45/20°C	MAHT (l)	N- ekponent	KAAL (kg)
Tüüp 21									
600	70		F072102006011300	94	167	181	1.5	1.33	6.5
700	70		F072102007011300	110	194	211	1.8	1.33	7.6
800	70		F072102008011300	126	222	241	2.0	1.33	8.6
900	70		F072102009011300	142	250	272	2.3	1.33	10.1
1000	70		F072102010011300	157	278	302	2.5	1.33	18
1100	70		F072102011011300	173	306	332	2.8	1.33	11.9
1200	70		F072102012011300	189	333	362	3.0	1.33	13.0
1400	70		F072102014011300	220	389	422	3.5	1.33	15.7
1600	70		F072102016011300	252	445	483	4.0	1.33	17.3
1800	70		F072102018011300	283	500	543	4.5	1.33	19.4
2000	70		F072102020011300	315	556	603	5.0	1.33	21.6
2300	70		F072102023011300	362	639	694	5.8	1.33	24.8
2600	70		F072102026011300	409	722	784	6.5	1.33	28.6
3000	70		F072102030011300	472	834	905	7.5	1.33	32.4
Tüüp 22									
600	102		F072202006011300	125	221	239	1.5	1.33	7.8
700	102		F072202007011300	146	257	279	1.8	1.33	8.6
800	102		F072202008011300	167	294	319	2.0	1.33	10.4
900	102		F072202009011300	188	331	359	2.3	1.33	11.4
1000	102		F072202010011300	209	368	399	2.5	1.33	12.3
1100	102		F072202011011300	230	404	439	2.8	1.33	13.5
1200	102		F072202012011300	250	441	479	3.0	1.33	14.8
1400	102		F072202014011300	292	515	559	3.5	1.33	17.5
1600	102		F072202016011300	334	588	638	4.0	1.33	19.5



200

KÕRGUS 200 mm	PIKKUS	SÜGAVUS		Võimsus (W) 45/35/20°C	Võimsus (W) 55/45/20°C	Võimsus (W) 60/45/20°C	MAHT (l)	N- ekponent	KAAL (kg)
	1800	102	F072202018011300	376	662	718	4.5	1.33	21.9
	2000	102	F072202020011300	417	735	798	5.0	1.33	24.4
	2300	102	F072202023011300	480	845	918	5.8	1.33	28.0
	2600	102	F072202026011300	543	956	1037	6.5	1.33	31.7
	3000	102	F072202030011300	626	1103	1197	7.5	1.33	36.5

Tüüp 33

600	152	F073302006011310	F073302006011300	175	309	336	2.3	1.34	12.8
700	152	F073302007011310	F073302007011300	204	361	392	2.7	1.34	15.0
800	152	F073302008011310	F073302008011300	233	412	448	3.0	1.34	17.2
900	152	F073302009011310	F073302009011300	262	464	504	3.4	1.34	19.3
1000	152	F073302010011310	F073302010011300	291	515	560	3.8	1.34	21.4
1100	152	F073302011011310	F073302011011300	320	567	616	4.2	1.34	23.6
1200	152	F073302012011310	F073302012011300	349	618	672	4.6	1.34	25.8
1400	152	F073302014011310	F073302014011300	407	721	784	5.3	1.34	3.5
1600	152	F073302016011310	F073302016011300	465	825	896	6.1	1.34	34.3
1800	152	F073302018011310	F073302018011300	524	928	1008	6.8	1.34	38.5
2000	152	F073302020011310	F073302020011300	582	1031	1120	7.6	1.34	42.9
2300	152	F073302023011310	F073302023011300	669	1185	1288	8.7	1.34	49.3
2600	152	F073302026011310	F073302026011300	756	1340	1455	9.9	1.34	55.6
3000	152	F073302030011310	F073302030011300	873	1546	1679	11.4	1.34	64.2

Tüüp 44

600	202	F074402006011300		226	402	437	3.3	1.35	16.3
700	202	F074402007011300		264	469	510	3.9	1.35	18.7
800	202	F074402008011300		301	536	583	4.4	1.35	21.4
900	202	F074402009011300		339	603	656	5.0	1.35	24.5
1000	202	F074402010011300		377	670	729	5.5	1.35	26.7



200

KÕRGUS 200 mm	PIKKUS	SÜGAVUS		Võimsus (W) 45/35/20°C	Võimsus (W) 55/45/20°C	Võimsus (W) 60/45/20°C	MAHT (l)	N- ekponent	KAAL (kg)
	1100	202	F074402011011300	414	737	802	6.0	1.35	29.4
	1200	202	F074402012011300	452	804	874	6.6	1.35	32.9
	1400	202	F074402014011300	527	938	1020	7.7	1.35	37.4
	1600	202	F074402016011300	602	1073	1166	8.8	1.35	42.7
	1800	202	F074402018011300	678	1207	1312	9.9	1.35	50.0
	2000	202	F074402020011300	753	1341	1457	11.0	1.35	53.4
	2300	202	F074402023011300	866	1542	1676	12.7	1.35	61.5
	2600	202	F074402026011300	979	1743	1894	14.3	1.35	69.4
	3000	202	F074402030011300	1130	2011	2186	16.5	1.35	8.2