



Andmeleht
2026-06-07

Plint PD

Madalaim paneelradiaator sileda paneeliga mõlemal poolel.



- ✓ Elegantne välimus
- ✓ Mitmekülgne paigaldus
- ✓ Stabiilne töö
- ✓ Paindlikud mõõdud
- ✓ Lihtne hooldus

Plint PD paneelradiaator sileda esi- ja tagapinnaga, 200 mm kõrge, alumise ühendusega, tagab esteetilise ja tõhusa kütelahenduse; standardtoon RAL 9016.



Kasutusala

Purmo Plint PD on mõeldud elamutele, büroodele, koolidele ja tervishoiuasutustele. Kõrgus 200 mm, pikkus 600–3000 mm. Radiaatoril on siledad esipaneelid ja tagapaneelid, mis tagavad lihtsa hoolduse ja funktsionaalse välimuse.

Möödistamine

Õige tootevaliku tagamiseks kasutage meie kalkulaatoreid ja tootekatalooge. Kui vajate abi, võtke ühendust meie müügimeeskonnaga.

Kasutamine

Veendu, et Plint PD oleks paigaldatud õigesti seinä- või põrandapaigalduse juhiste järgi, arvestades seadme mõõte (kõrgus 200 mm, pikkus 600–3000 mm); komplektis on kuus ühendust, kuid enne paigaldust kinnita ühenduse tüüp; regulaarne hooldus hõlmab siledade pindade puhastamist esteetika ja töövõime säilitamiseks, kasutustemperatuur ei tohi ületada 110°C ega rõhk 10 bar.

AMA-tekst

Plint PD paneelradiaator (200 mm kõrgune) sileda esipaneeli ja tagapaneeliga, alumise ühendusega (2×G 1/2"). Integreeritud ventiilisüdamik ja diskreetne torustiku paigutus. Vastab EN442-1 ja CE. RAL 9016; muud värvid tellimisel. Garantii 10 aastat.



Spetsifikatsioonid

OMADUSED	ÜHIK	VÄÄRTUSED
ETIM-klass		EC011022
Materjal		Terase
Tüüp		21, 22, 33, 44
Pinnastruktuur		Sile tasane
Maksimaalne töö rõhk	bar	10
Standardühenduste arv		2
Soojusandmine vastavalt EN 442 tunnustatud laborile		Jah
Maksimaalne töötemperatuur	°C	110
Standardvärv		Jah
Värv		Valge
RAL-number		9016
Rest/Katteplaat		Jah
Rest/Katteplaat		Jah
Läikeväärtus		Särav
Keerme mõõt (toll)		1/2 tolli
Ühenduskeere		Sisemine keere
Ühepunktiühendusega		Jah
Õhutusühendusega		Jah
Õhutusventiili/õhutusavaga		Jah
Tühjendusvõimalusega		Jah



Ressursid



ProductImage - Panel radiator Plint P 200 mm.

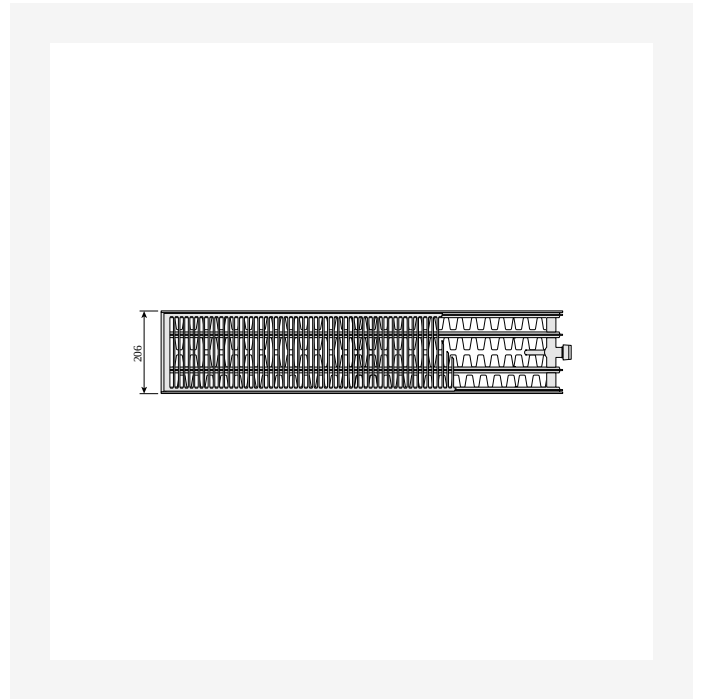

DimensionalDrawing - Plint PD ja Plint RD, tüüp 44, pealtvaade

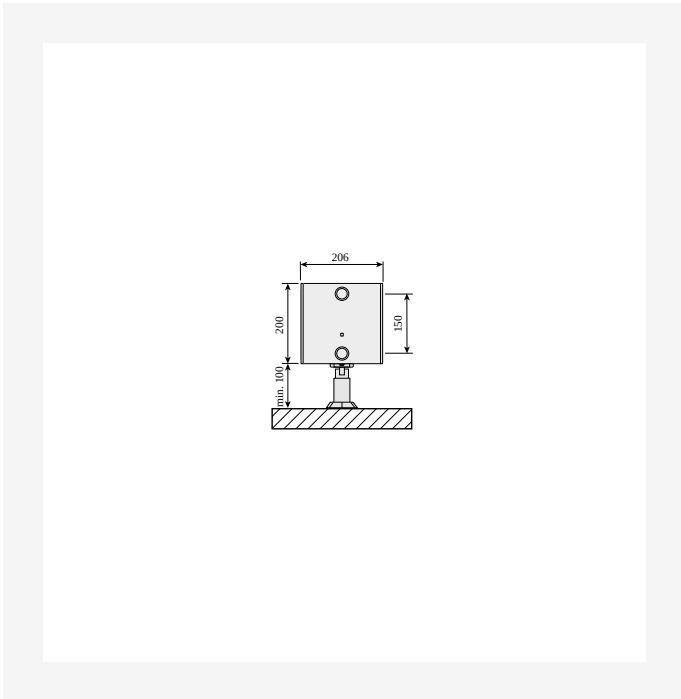

DimensionalDrawing - Plint PD ja Plint RD, tüüp 44, pörandakinnitustega, külgsaade

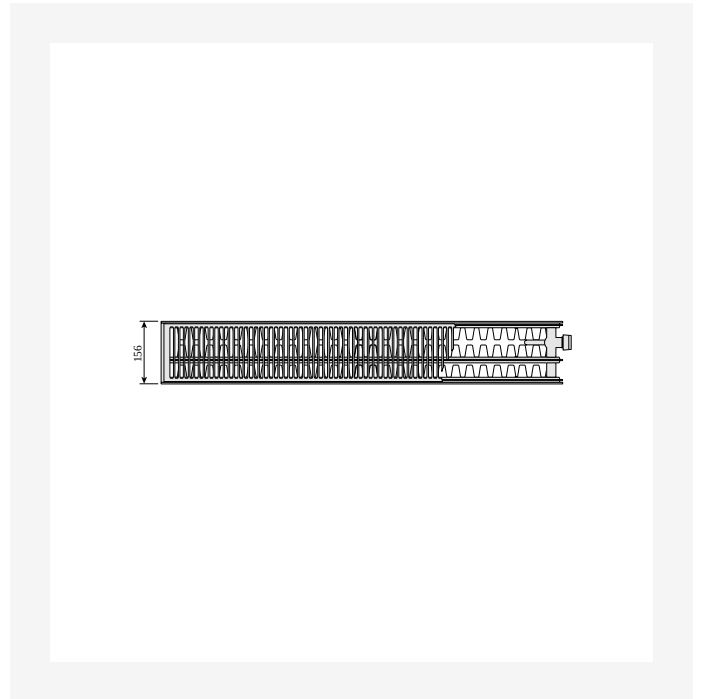

DimensionalDrawing - Plint PD ja Plint RD, tüüp 33, pealtvaade

Ressursid

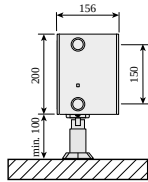

DimensionalDrawing - Plint PD ja Plint RD, tüüp 33, põrandakinnitustega, külgsaade

DimensionalDrawing - Plint PD ja Plint RD, tüüp 22, pealtvaade

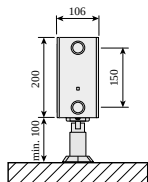

DimensionalDrawing - Plint PD ja Plint RD, tüüp 22, põrandakinnitustega, külgsaade

DimensionalDrawing - Plint PD ja Plint RD, tüüp 21s, pealtvaade



Ressursid

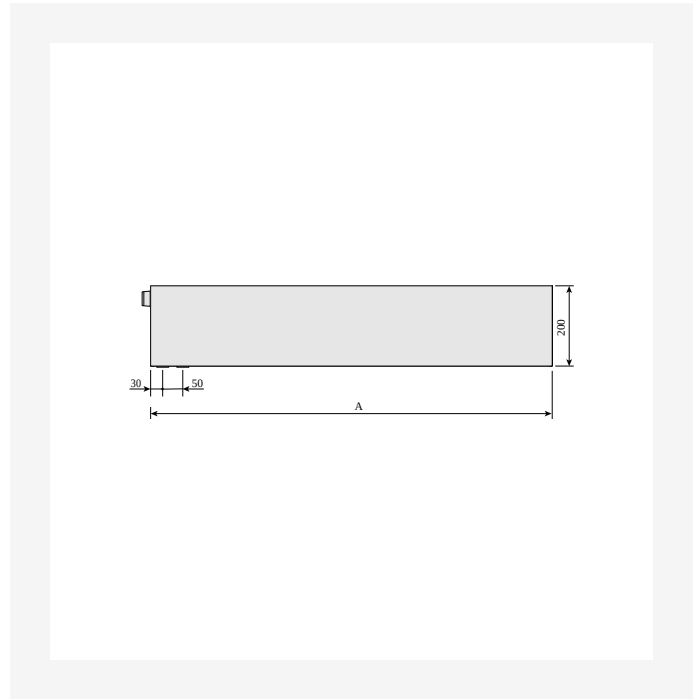
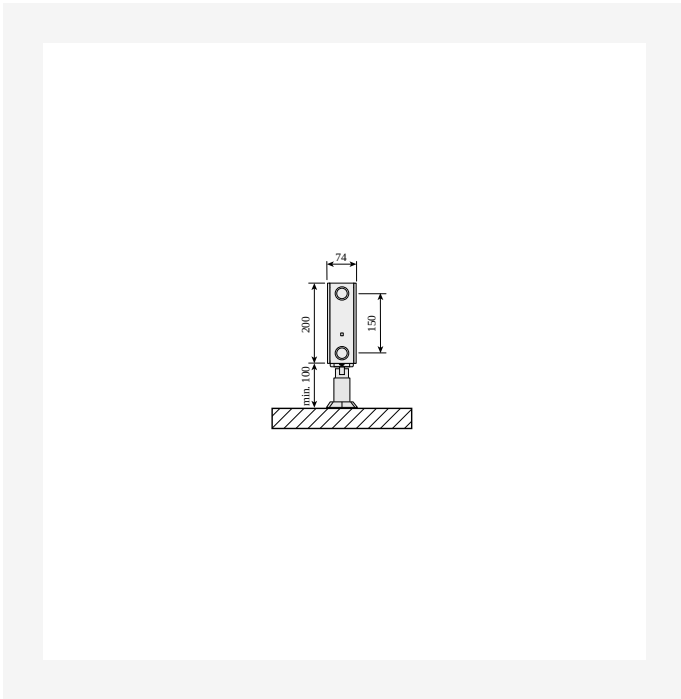

DimensionalDrawing - Plint PD ja Plint RD, tüüp 21s, põrandakinnitustega, külgsaade

DimensionalDrawing - Plint PD, tagantvaade

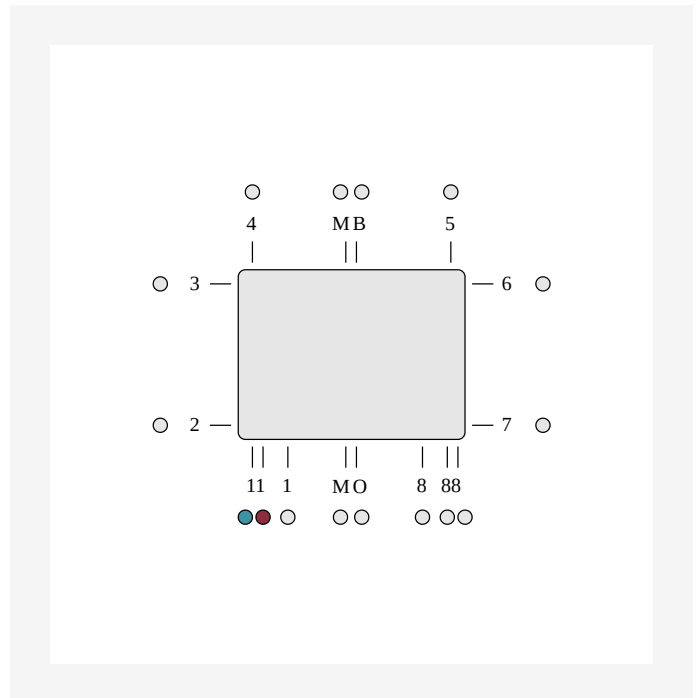
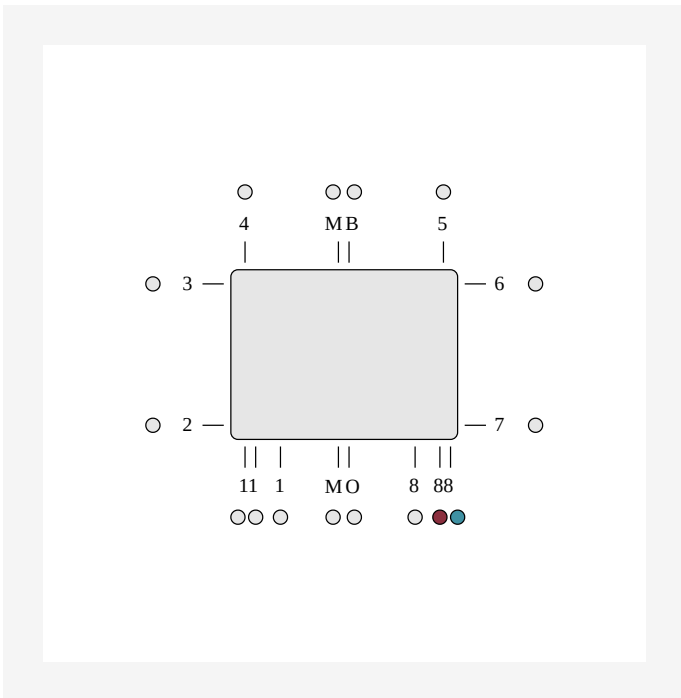

DimensionalDrawing - ETIM 88 LR alumine ühendus. Integreeritud ventiliiga alumine ühendus nõuab ventiilisestiku kasutamist. Kasutamata ühendused on suletud.

DimensionalDrawing - ETIM 11 alumine ühendus, sisend paremal, väljund vasakul. Alumine ühendus integreeritud kapillaartoruga nõuab ventiliinserti kasutamist. Kasutamata ühendused on suletud.



Seotud tooted



Ventiili sisetükk M30 OV



Top Grill ©



Õhutus- ja pimekorgi komplekt



Plint põrandakronstein



Aerosool parandusvärv



Küljepaneel ©



Õhutusvõti



Monclac Plint seinakronstein



Parandussvärvi sprej



Evosense



200

KÕRGUS 200 mm	PIKKUS	SÜGAVUS		Võimsus (W) 45/35/20°C	Võimsus (W) 55/45/20°C	Võimsus (W) 60/45/20°C	MAHT (l)	N- ekponent	KAAL (kg)
Tüüp 21									
600	74		FOA2102006015300	94	165	179	1.5	1.31	8.3
700	74		FOA2102007015300	110	192	208	1.8	1.31	10.1
800	74		FOA2102008015300	125	220	238	2.0	1.31	11.2
900	74		FOA2102009015300	141	247	268	2.3	1.31	12.4
1000	74		FOA2102010015300	157	275	298	2.5	1.31	13.8
1100	74		FOA2102011015300	172	302	327	2.8	1.31	15.2
1200	74		FOA2102012015300	188	329	357	3.0	1.31	16.6
1400	74		FOA2102014015300	219	384	417	3.5	1.31	19.8
1600	74		FOA2102016015300	251	439	476	4.0	1.31	22.4
1800	74		FOA2102018015300	282	494	536	4.5	1.31	24.8
2000	74		FOA2102020015300	313	549	595	5.0	1.31	27.6
2300	74		FOA2102023015300	360	631	685	5.8	1.31	31.7
2600	74		FOA2102026015300	407	714	774	6.5	1.31	35.9
3000	74		FOA2102030015300	470	824	893	7.5	1.31	41.4
Tüüp 22									
600	106		FOA2202006015300	125	219	238	1.5	1.32	9.2
700	106		FOA2202007015300	146	256	278	1.8	1.32	11.3
800	106		FOA2202008015300	167	293	317	2.0	1.32	12.9
900	106		FOA2202009015300	188	329	357	2.3	1.32	14.5
1000	106		FOA2202010015300	208	366	397	2.5	1.32	16.1
1100	106		FOA2202011015300	229	402	436	2.8	1.32	17.8
1200	106		FOA2202012015300	250	439	476	3.0	1.32	19.4
1400	106		FOA2202014015300	292	512	555	3.5	1.32	22.6
1600	106		FOA2202016015300	334	585	635	4.0	1.32	25.8



200

KÕRGUS 200 mm	PIKKUS	SÜGAVUS		Võimsus (W) 45/35/20°C	Võimsus (W) 55/45/20°C	Võimsus (W) 60/45/20°C	MAHT (l)	N- ekponent	KAAL (kg)
	1800	106	FOA2202018015300	375	658	714	4.5	1.32	29.0
	2000	106	FOA2202020015300	417	732	794	5.0	1.32	32.2
	2300	106	FOA2202023015300	479	841	913	5.8	1.32	37.4
	2600	106	FOA2202026015300	542	951	1032	6.5	1.32	41.9
	3000	106	FOA2202030015300	625	1097	1190	7.5	1.32	48.4
Tüüp 33									
	600	156	FOA3302006015310 FOA3302006015300	169	301	327	2.3	1.35	13.8
	700	156	FOA3302007015310 FOA3302007015300	197	351	381	2.7	1.35	16.1
	800	156	FOA3302008015310 FOA3302008015300	226	401	435	3.0	1.35	18.4
	900	156	FOA3302009015310 FOA3302009015300	254	451	490	3.4	1.35	14.6
	1000	156	FOA3302010015310 FOA3302010015300	282	501	544	3.8	1.35	23.6
	1100	156	FOA3302011015310 FOA3302011015300	310	551	599	4.2	1.35	25.4
	1200	156	FOA3302012015310 FOA3302012015300	338	601	653	4.6	1.35	27.7
	1400	156	FOA3302014015310 FOA3302014015300	395	701	762	5.3	1.35	32.3
	1600	156	FOA3302016015310 FOA3302016015300	451	801	871	6.1	1.35	36.9
	1800	156	FOA3302018015310 FOA3302018015300	508	902	980	6.8	1.35	41.6
	2000	156	FOA3302020015310 FOA3302020015300	564	1002	1088	7.6	1.35	46.1
	2300	156	FOA3302023015310 FOA3302023015300	649	1152	1252	8.7	1.35	53.9
	2600	156	FOA3302026015310 FOA3302026015300	733	1302	1415	9.9	1.35	59.9
	3000	156	FOA3302030015310 FOA3302030015300	846	1503	1633	11.4	1.35	69.2
Tüüp 44									
	600	206	FOA4402006015300	226	400	434	3.3	1.34	17.3
	700	206	FOA4402007015300	263	466	507	3.9	1.34	19.8
	800	206	FOA4402008015300	301	533	579	4.4	1.34	22.7
	900	206	FOA4402009015300	339	600	651	5.0	1.34	25.5
	1000	206	FOA4402010015300	376	666	724	5.5	1.34	29.5



200

KÕRGUS 200 mm	PIKKUS	SÜGAVUS		Võimsus (W) 45/35/20°C	Võimsus (W) 55/45/20°C	Võimsus (W) 60/45/20°C	MAHT (l)	N- ekponent	KAAL (kg)
	1100	206	FOA4402011015300	414	733	796	6.0	1.34	31.2
	1200	206	FOA4402012015300	451	800	869	6.6	1.34	34.8
	1400	206	FOA4402014015300	527	933	1013	7.7	1.34	39.8
	1600	206	FOA4402016015300	602	1066	1158	8.8	1.34	45.4
	1800	206	FOA4402018015300	677	1199	1303	9.9	1.34	51.8
	2000	206	FOA4402020015300	752	1333	1448	11.0	1.34	56.8
	2300	206	FOA4402023015300	865	1533	1665	12.7	1.34	65.4
	2600	206	FOA4402026015300	978	1733	1882	14.3	1.34	73.8
	3000	206	FOA4402030015300	1129	1999	2171	16.5	1.34	85.1