



**Datablad**

2026-06-07

# Plint PD

The compact panel radiator Plint PD has flat front and rear panels.



- ✓ Elegant design
- ✓ Intelligente varme- og kølefunktioner
- ✓ Robust ydeevne
- ✓ Nemt at montere
- ✓ Nem vedligeholdelse

**Plint PD** is a traditional panel radiator with flat front for closed hydronic systems. Perfect in front of large windows. White RAL 9016 finish.



### Anvendelsesområde

Plint PD er ideel til brug i boliger, kontorer, skoler og sundhedsfaciliteter. Med sin universelle højde på 200mm og længder fra 600mm til 3000mm tilbyder den en strømlinet varmeløsning. Designet med både for- og bagside glatte plader sikrer et moderne æstetisk udtryk velegnet til nutidige arkitektoniske stilarter

### Dimensionering

For nøjagtig produktvalg og beregning, henvis venligst til vores designservice eller brug vores brochure til hurtig udvælgelse baseret på det nødvendige rumstørrelse og varmebehov

### Anvendelse

Sørg for korrekt installation af Plint PD ved at følge retningslinjerne for væg- eller gulvmontering og tage

højde for dimensionerne (højde: 200mm, længde: 600-3000mm). Seks forbindelseskoblinger medfølger; bekræft dog forbindelsestypen før installation. Regelmæssig vedligeholdelse inkluderer rengøring af de glatte overflader for at opretholde æstetik og effektivitet. Driftsbetingelserne må ikke overstige en maksimal temperatur på 110°C og et tryk på 10 bar

### AMA-tekst

Plint PD radiatoren er en universel, flad panelradiator velegnet til moderne interiører. Den har glatte, helt flade for- og bagpaneler. Fås med en ensartet højde på 200mm og længder fra 600mm til 3000mm. Radiatoren inkluderer seks koblinger for fleksible tilslutningsmuligheder og har fremragende ydeevne med en maksimal driftstemperatur på 110°C og et arbejdsstryk op til 10 bar. Ideel til boliger, kommercielle og offentlige bygninger, den kombinerer æstetisk appel med funktionel effektivitet



# Specifikationer

EGENSKABER	ENHED	VÆRDIER
ETIM-klasse		EC011022
Materiale		Stål
Type		21, 22, 33, 44
Overfladestruktur		Flad glat
Maks. arbejdsstryk	bar	10
Antal standardtilslutninger		2
Varmeafgivelse iht. anerkendt EN 442-laboratorium		Ja
Maks. driftstemperatur	°C	110
Standardfarve		Ja
Farve		Hvid
RAL-nummer		9016
Gitter/Dækkplade		Ja
Gitter/Dækkplade		Ja
Glansværdi		Glansfuld
Gængedimension (tomme)		1/2 tomme
Tilslutning gevind		Intern gevind
Med etpunkttilslutning		Ja
Med udluftningstilslutning		Ja
Med udluftningsventil/aflufter		Ja
Med aftapningsmulighed		Ja



# Dokumenter

DOKUMENTER	DOKUMENTTYPE	LINK
Installationsmanual for væg- og gulvkonsoller for Plint radiators	User	<a href="https://asset.productmarketingcloud.com/api/assetstorage/3577_eaef6207-b2e6-4e25-845f-dab07cabcbc0">https://asset.productmarketingcloud.com/api/assetstorage/3577_eaef6207-b2e6-4e25-845f-dab07cabcbc0</a>
Taethedstest	Installation	<a href="https://asset.productmarketingcloud.com/api/assetstorage/3577_c37363c0-7a55-470a-bf93-031f44c77bbe">https://asset.productmarketingcloud.com/api/assetstorage/3577_c37363c0-7a55-470a-bf93-031f44c77bbe</a>



# Ressourcer



ProductImage - Panel radiator Plint P 200 mm.

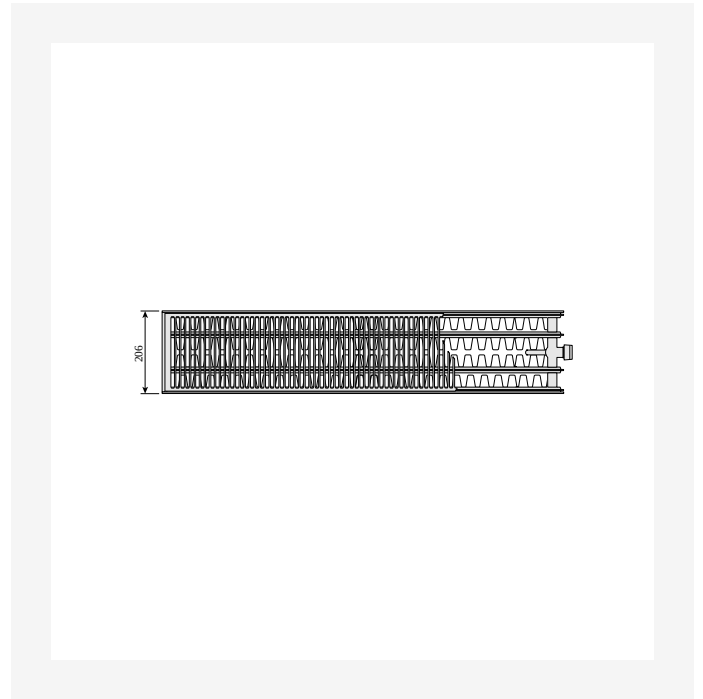

DimensionalDrawing - Plint PD og Plint RD, type 44, set oppefra

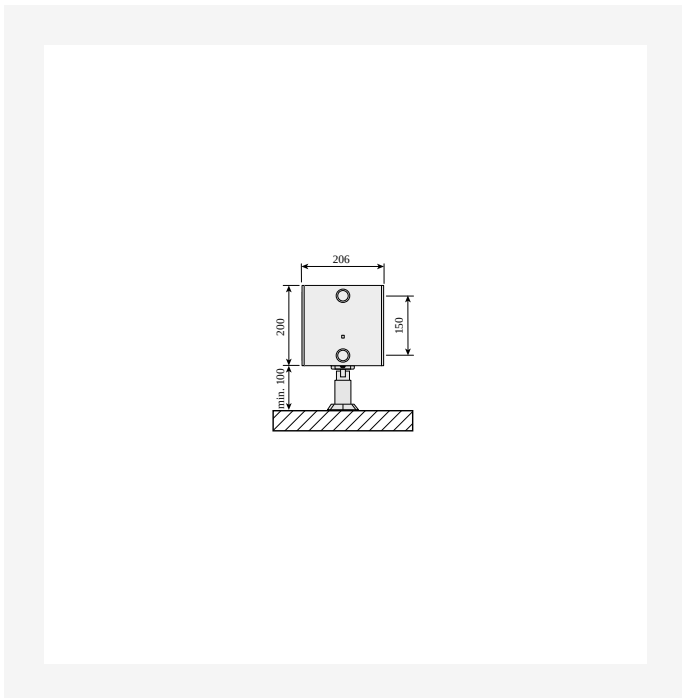

DimensionalDrawing - Plint PD og Plint RD, type 44, med gulvbeslag, sidevisning

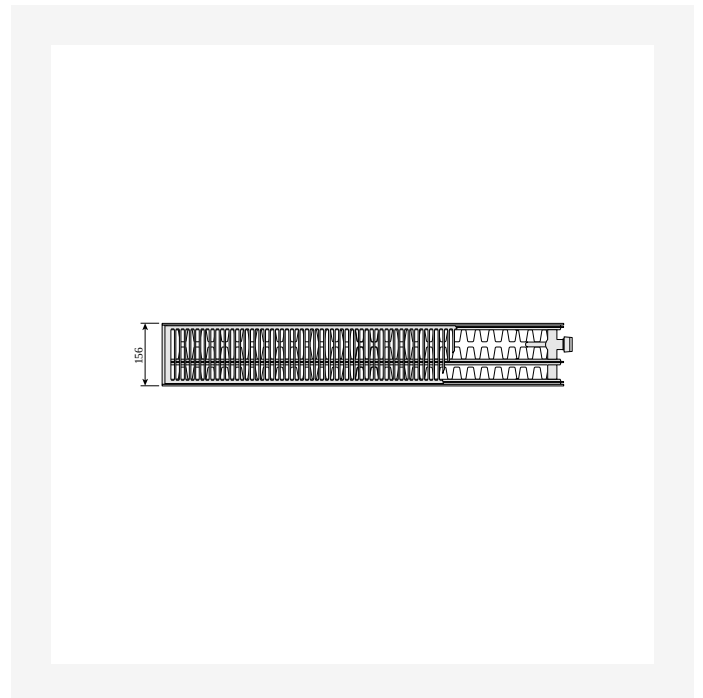

DimensionalDrawing - Plint PD og Plint RD, type 33, set oppefra



# Ressourcer

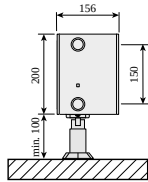

DimensionalDrawing - Plint PD og Plint RD, type 33, med gulvbeslag, sidevisning

DimensionalDrawing - Plint PD og Plint RD, type 22, set oppefra

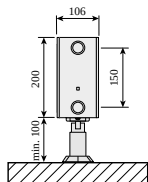

DimensionalDrawing - Plint PD og Plint RD, type 22, med gulvbeslag, sidevisning

DimensionalDrawing - Plint PD og Plint RD, type 21s, set oppefra



# Ressourcer

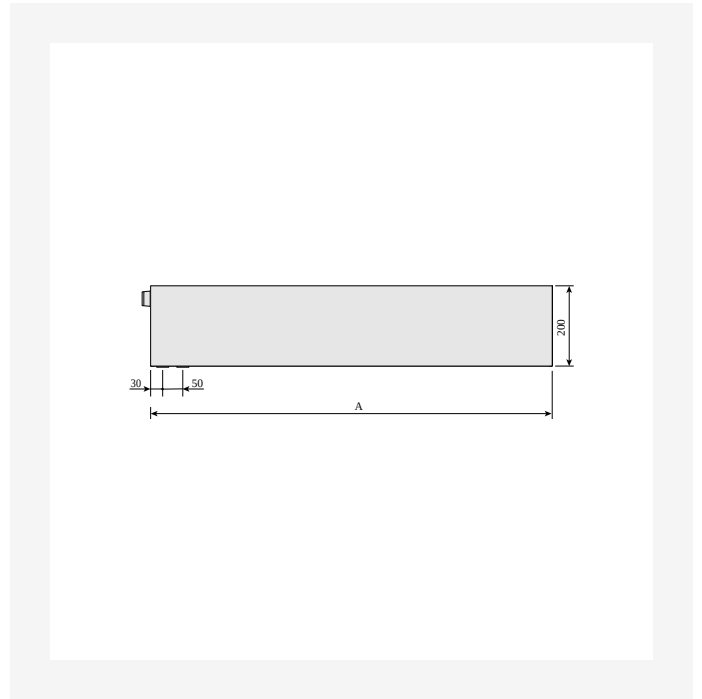
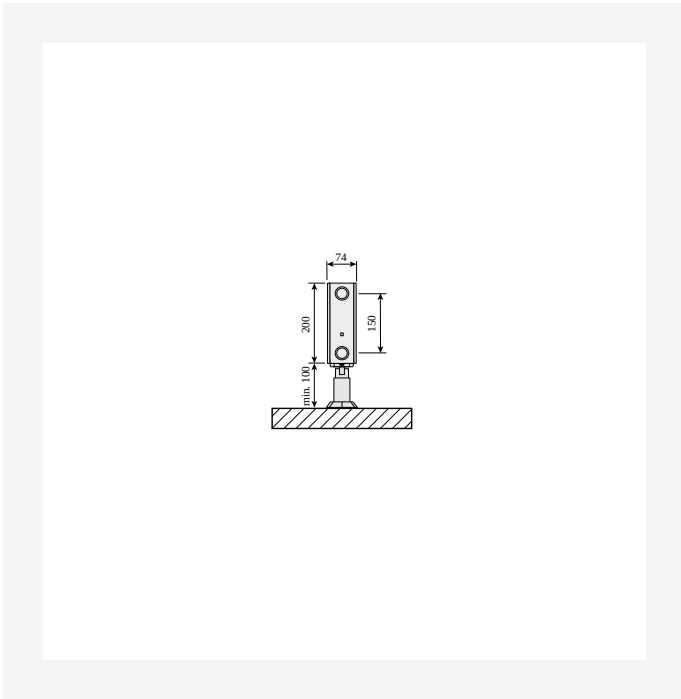

DimensionalDrawing - Plint PD og Plint RD, type 21s, med gulvbeslag, sidevisning

DimensionalDrawing - Plint PD, bagfra

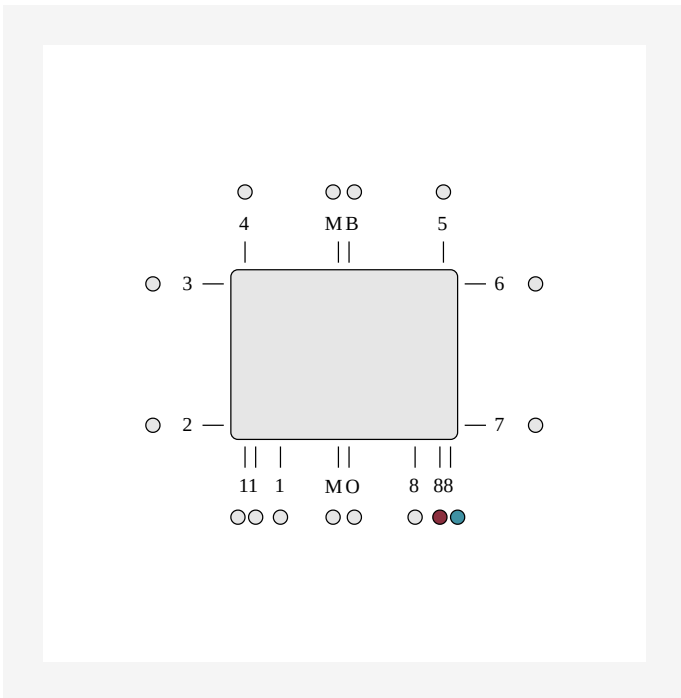

DimensionalDrawing - ETIM 88 LR Bundtilslutning. Bundtilslutning via integreret ventil kræver brug af ventilindsats. Ubrugte tilslutninger er lukkede.

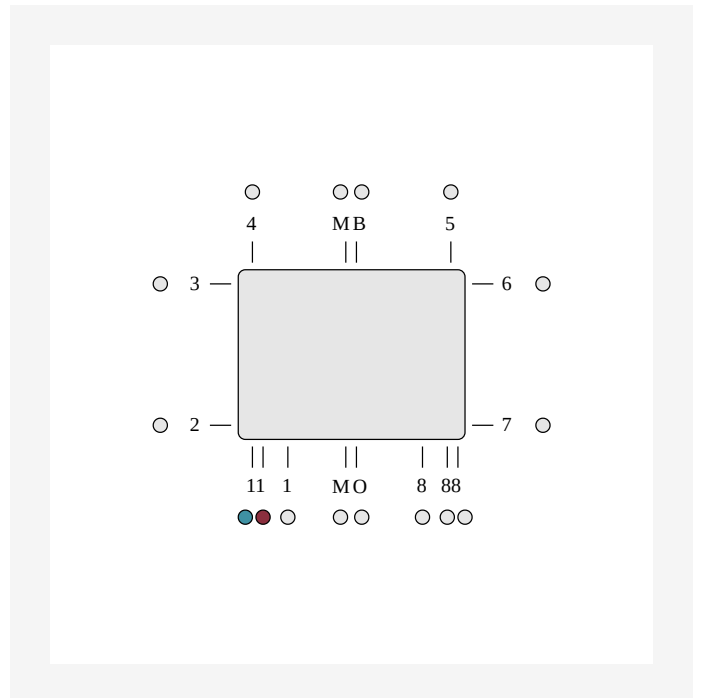

DimensionalDrawing - ETIM 11 Bundtilslutning, ind højre, ud venstre. Bundtilslutning via integreret kapillarrør kræver brug af ventilindsats. Ubrugte tilslutninger er lukkede.



## Relaterede produkter



Ventilindsats M30 Konus

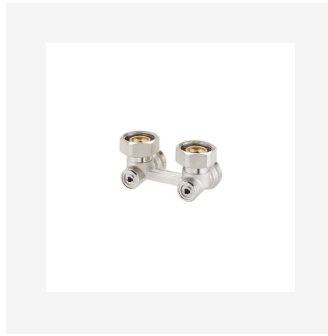

H-stykke med afspærringer  
cc50 G3/42



Toprist Purmo



Udluftningskrue og  
blindprop



Gulvkonsol Purmo Monclac  
Plint



Reparationslak



Purmo sidepanel



Air Vent 1/2"



Udluftningsnøgle



Reparationsmaling spray



Termostat Evosense



# Relaterede produkter



Termostat Evosense Public

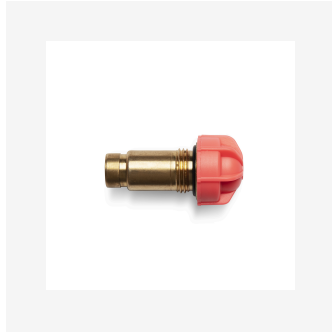

Flamingo



# 200

HØJDE 200 mm	LÆNGDE	DYBDE	Varenr./ VVS (V)	Varenr./ VVS (H)	EFFEKT (W) 45/35/20°C	EFFEKT (W) 55/45/20°C	EFFEKT (W) 60/45/20°C	VOLUMEN (l)	N- ekponent	VÆGT (kg)
<b>Type 21</b>										
600	74		FOA2102006015380		94	165	179	0.0	1.31	8.6
700	74		FOA2102007015380		110	192	208	0.0	1.31	10.1
800	74		FOA2102008015380	328723568	125	220	238	2.0	1.31	11.4
900	74		FOA2102009015380		141	247	268	0.0	1.31	12.9
1000	74		FOA2102010015380	328723570	157	275	298	2.5	1.31	14.3
1100	74		FOA2102011015380		172	302	328	0.0	1.31	15.8
1200	74		FOA2102012015380		188	329	357	0.0	1.31	17.3
1400	74		FOA2102014015380	328723574	219	384	417	3.5	1.31	20.6
1600	74		FOA2102016015380		251	439	476	0.0	1.31	23.3
1800	74		FOA2102018015380		282	494	536	0.0	1.31	25.8
2000	74		FOA2102020015380		313	549	595	0.0	1.31	28.7
2300	74		FOA2102023015380		360	631	685	0.0	1.31	33.0
2600	74		FOA2102026015380		407	714	774	0.0	1.31	37.3
3000	74		FOA2102030015380		470	824	893	0.0	1.31	43.0
<b>Type 22</b>										
600	106		FOA2202006015380		125	219	238	0.0	1.32	9.6
700	106		FOA2202007015380		146	256	278	0.0	1.32	11.8
800	106		FOA2202008015380		167	293	318	0.0	1.32	13.4
900	106		FOA2202009015380	328724569	188,187	329	357	2.3	1.32	15.1
1000	106		FOA2202010015380	328724570	208	366	397	2.5	1.32	16.8
1100	106		FOA2202011015380	328724571	229	402	437,436	2.8	1.32	18.5
1200	106		FOA2202012015380		250	439	476	0.0	1.32	20.2
1400	106		FOA2202014015380		292	512	556	0.0	1.32	23.4
1600	106		FOA2202016015380		333	585	635	0.0	1.32	26.8



## 200

HØJDE 200 mm	LÆNGDE	DYBDE	Varenr./ VVS (V)	Varenr./ VVS (H)	EFFEKT (W) 45/35/20°C	EFFEKT (W) 55/45/20°C	EFFEKT (W) 60/45/20°C	VOLUMEN (l)	N- ekponent	VÆGT (kg)
	1800	106	FOA2202018015380		375	658	715	0.0	1.32	30.1
	2000	106	FOA2202020015380		417	732	794	0.0	1.32	33.5
	2300	106	FOA2202023015380		479	841	913	0.0	1.32	38.5
	2600	106	FOA2202026015380		542	951	1032	0.0	1.32	43.6
	3000	106	FOA2202030015380		625	1097	1191	0.0	1.32	50.3
<b>Type 33</b>										
	600	156	FOA3302006015380	328726266	169	301	327	2.3	1.35	14.3
	700	156	FOA3302007015390	FOA3302007015380	197	351	381	0.0	1.35	16.8
	800	156	FOA3302008015390	FOA3302008015380	226	401	436	0.0	1.35	19.2
	900	156	FOA3302009015390	FOA3302009015380	254	451	490	0.0	1.35	15.2
	1000	156	FOA3302010015390	FOA3302010015380	282	501	544	0.0	1.35	24.0
	1100	156	FOA3302011015390	FOA3302011015380	310	551	599	0.0	1.35	26.4
	1200	156	FOA3302012015380	328726272	338	601	653	4.6	1.35	28.8
	1400	156	FOA3302014015380	328726174	395	701	762	5.3	1.35	33.6
	1600	156	FOA3302016015380	328726276	451	801	871	6.1	1.35	38.3
	1800	156	FOA3302018015390	FOA3302018015380	508	902	980	0.0	1.35	43.2
	2000	156	FOA3302020015390	FOA3302020015380	564	1002	1089	0.0	1.35	48.0
	2300	156	FOA3302023015390	FOA3302023015380	649	1152	1252	0.0	1.35	55.2
	2600	156	FOA3302026015380	328726286	733	1302	1415	9.9	1.35	62.3
	3000	156	FOA3302030015390	FOA3302030015380	846	1503	1633	0.0	1.35	72.0
<b>Type 44</b>										
	600	206	FOA4402006015380		226	400	435	0.0	1.34	17.7
	700	206	FOA4402007015380		263	466	507	0.0	1.34	20.6
	800	206	FOA4402008015380		301	533	579	0.0	1.34	23.6
	900	206	FOA4402009015380		339	600	652	0.0	1.34	26.6
	1000	206	FOA4402010015380		376	666	724	0.0	1.34	29.5



# 200

HØJDE 200 mm	LÆNGDE	DYBDE	Varenr./ VVS(V)	Varenr./ VVS(H)	EFFEKT (W) 45/35/20°C	EFFEKT (W) 55/45/20°C	EFFEKT (W) 60/45/20°C	VOLUMEN (l)	N- ekponent	VÆGT (kg)
	1100	206	F0A4402011015380		414	733	796	0.0	1.34	32.5
	1200	206	F0A4402012015380		451	800	869	0.0	1.34	35.4
	1400	206	F0A4402014015380		526	933	1013	0.0	1.34	41.4
	1600	206	F0A4402016015380		602	1066	1159	0.0	1.34	47.2
	1800	206	F0A4402018015380		677	1199	1303	0.0	1.34	53.1
	2000	206	F0A4402020015380		752	1333	1448	0.0	1.34	59.0
	2300	206	F0A4402023015380		865	1533	1665	0.0	1.34	67.9
	2600	206	F0A4402026015380		978	1733	1882	0.0	1.34	76.7
	3000	206	F0A4402030015380		1128	1999	2172	0.0	1.34	88.5